

NAIS

2 A CAPACITY RELAY WITH HIGH SURGE VOLTAGE & HIGH BREAKDOWN VOLTAGE

TX RELAYS

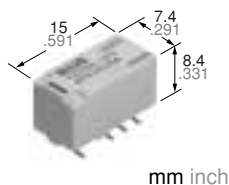
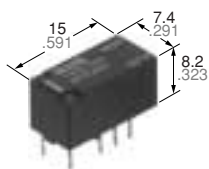

mm inch

FEATURES

- Breakdown voltage between contacts and coil: 2,000 V
- Surge withstand between contacts and coil: 2,500 V
- High contact capacity: 2 A 30 V DC
- Surface-mount type available

SPECIFICATIONS

Contact

Arrangement	2 Form C	
Initial contact resistance, max. (By voltage drop 6 V DC 1 A)	100 mΩ	
Contact material	Gold-clad silver alloy	
Rating	Nominal switching capacity (resistive load)	2 A 30 V DC
	Max. switching power (resistive load)	60 W
	Max. switching voltage	220 V DC
	Max. switching current	2 A
	Min. switching capacity *1	10 μA 10 mV DC
Nominal operating power	Single side stable	140 mW (1.5 to 24 V DC) 270 mW (48 V DC)
	1 coil latching	100 mW (1.5 to 24 V DC)
	2 coil latching	200 mW (1.5 to 24 V DC)
Expected life (min. operations)	Mechanical (at 180 cpm)	10 ⁸
	Electrical (at 20 cpm)	2 A 30 V DC resistive
		1 A 30 V DC resistive

Notes:

*1 This value can change due to the switching frequency, environmental conditions, and desired reliability level, therefore it is recommended to check this with the actual load. (SX relays are available for low level load switching [10 μA 1 mV DC – 10 mA 10 V DC])

*2 The upper limit for the ambient temperature is the maximum temperature that can satisfy the coil temperature rise. Under the packing condition, allowable temperature range is from -40 to +70°C -40°C to +158°F.

Remarks

* Specifications will vary with foreign standards certification ratings.

*1 Measurement at same location as "Initial breakdown voltage" section.

*2 By resistive method, nominal voltage applied to the coil; contact carrying current: 2 A.

*3 Nominal voltage applied to the coil, excluding contact bounce time.

*4 Nominal voltage applied to the coil, excluding contact bounce time without diode.

*5 Half-wave pulse of sine wave: 6 ms; detection time: 10 μs.

*6 Half-wave pulse of sine wave: 6 ms.

*7 Detection time: 10 μs.

*8 Refer to 6. Conditions for operation, transport and storage mentioned in AMBIENT ENVIRONMENT.

Characteristics

Initial insulation resistance*1	Min. 1,000 MΩ (at 500 V DC)	
Initial breakdown voltage	Between open contacts	1,000 Vrms for 1 min. (Detection current: 10 mA)
	Between contact sets	1,000 Vrms for 1 min. (Detection current: 10 mA)
	Between contact and coil	2,000 Vrms for 1 min. (Detection current: 10 mA)
Initial surge voltage	Between open contacts (10×160 μs)	1,500 V (FCC Part 68)
	Between contacts and coil (2×10 μs)	2,500 V (Telcordia)
Temperature rise*2 (at 20°C)	Max. 50°C	
Operate time [Set time]*3 (at 20°C)	Max. 4 ms (Approx. 2 ms) [Max. 4 ms (Approx. 2 ms)]	
Release time [Reset time]*4 (at 20°C)	Max. 4 ms (Approx. 1 ms) [Max. 4 ms (Approx. 2 ms)]	
Shock resistance	Functional*5	Min. 750 m/s ² {75 G}
	Destructive*6	Min. 1,000 m/s ² {100 G}
Vibration resistance	Functional*7	196 m/s ² {20 G}, 10 to 55 Hz at double amplitude of 3.3 mm
	Destructive	294 m/s ² {30G}, 10 to 55 Hz at double amplitude of 5 mm
Conditions for operation, transport and storage*8 (Not freezing and condensing at low temperature)	Ambient temperature *2	-40°C to +85°C (up to 24 V coil) -40°F to +185°F (up to 24 V coil) -40°C to +70°C (48 V coil) -40°F to +158°F (48 V coil)
	Humidity	5 to 85% R.H.
Unit weight	Approx. 2 g .071 oz	

ORDERING INFORMATION

Ex. TX 2 SA - L - H - 3V - Z

Contact arrangement	Surface-mount availability	Operating function	Terminal shape	Coil voltage (DC)	Packing style
2: 2 Form C	Nil: Standard PC board terminal type or self-clinching terminal type SA: Standard surface-mount terminal type SL: High connection reliability surface-mount terminal type SS: Space saving surface-mount terminal type	Nil: Single side stable L: 1 coil latching L2: 2 coil latching	Nil: Standard PC board terminal or surface-mount terminal H: Self-clinching terminal	1.5, 3, 4.5, 5, 6, 9, 12, 24, 48* V	Nil: Tube packing Z: Tape and reel packing(picked from the 8/9/10/12-pin side)

Notes: 1. Tape and reel (picked from 1/3/4/5-pin side) is also available by request. Part number suffix "-X" is needed when ordering.
(ex.) TX2SA-3 V-X

*48 V coil type: Single side stable only

2. Tape and reel packing symbol "-Z" or "-X" are not marked on the relay.

TYPES AND COIL DATA (at 20°C 68°F)

1) Standard PC board terminal type and self-clinching terminal type

1. Single side stable

Part No.		Nominal voltage, V DC	Pick-up voltage, V DC (max.)	Drop-out voltage, V DC (min.)	Nominal operating current, mA (±10%)	Coil resistance, Ω (±10%)	Nominal operating power, mW	Max. allowable voltage, V DC
Standard PC board terminal	Self-clinching terminal							
TX2-1.5 V	TX2-H-1.5 V	1.5	1.13	0.15	93.8	16	140	2.2
TX2-3 V	TX2-H-3 V	3	2.25	0.3	46.7	64.3	140	4.5
TX2-4.5 V	TX2-H-4.5 V	4.5	3.38	0.45	31	145	140	6.7
TX2-5 V	TX2-H-5 V	5	3.75	0.5	28.1	178	140	7.5
TX2-6 V	TX2-H-6 V	6	4.5	0.6	23.3	257	140	9
TX2-9 V	TX2-H-9 V	9	6.75	0.9	15.5	579	140	13.5
TX2-12 V	TX2-H-12 V	12	9	1.2	11.7	1,028	140	18
TX2-24 V	TX2-H-24 V	24	18	2.4	5.8	4,114	140	36
TX2-48 V	TX2-H-48 V	48	36	4.8	5.6	8,533	270	57.6

2. 1 Coil latching

Part No.		Nominal voltage, V DC	Set voltage, V DC (max.)	Reset voltage, V DC (max.)	Nominal operating current, mA (±10%)	Coil resistance, Ω (±10%)	Nominal operating power, mW	Max. allowable voltage, V DC
Standard PC board terminal	Self-clinching terminal							
TX2-L-1.5 V	TX2-L-H-1.5 V	1.5	1.13	1.13	66.7	22.5	100	2.2
TX2-L-3 V	TX2-L-H-3 V	3	2.25	2.25	33.3	90	100	4.5
TX2-L-4.5 V	TX2-L-H-4.5 V	4.5	3.38	3.38	22.2	202.5	100	6.7
TX2-L-5 V	TX2-L-H-5 V	5	3.75	3.75	20	250	100	7.5
TX2-L-6 V	TX2-L-H-6 V	6	4.5	4.5	16.7	360	100	9
TX2-L-9 V	TX2-L-H-9 V	9	6.75	6.75	11.1	810	100	13.5
TX2-L-12 V	TX2-L-H-12 V	12	9	9	8.3	1,440	100	18
TX2-L-24 V	TX2-L-H-24 V	24	18	18	4.2	5,760	100	36

3. 2 Coil latching

Part No.		Nominal voltage, V DC	Set voltage, V DC (max.)	Reset voltage, V DC (max.)	Nominal operating current, mA (±10%)	Coil resistance, Ω (±10%)	Nominal operating power, mW	Max. allowable voltage, V DC
Standard PC board terminal	Self-clinching terminal							
TX2-L2-1.5 V	TX2-L2-H-1.5 V	1.5	1.13	1.13	133.9	11.2	200	2.2
TX2-L2-3 V	TX2-L2-H-3 V	3	2.25	2.25	66.7	45	200	4.5
TX2-L2-4.5 V	TX2-L2-H-4.5 V	4.5	3.38	3.38	44.5	101.2	200	6.7
TX2-L2-5 V	TX2-L2-H-5 V	5	3.75	3.75	40	125	200	7.5
TX2-L2-6 V	TX2-L2-H-6 V	6	4.5	4.5	33.3	180	200	9
TX2-L2-9 V	TX2-L2-H-9 V	9	6.75	6.75	22.2	405	200	13.5
TX2-L2-12 V	TX2-L2-H-12 V	12	9	9	16.7	720	200	18
TX2-L2-24 V	TX2-L2-H-24 V	24	18	18	8.3	2,880	200	36

Notes:

1. Specified value of pick-up, drop-out, set and reset voltage is with the condition of square wave coil pulse.

2. Standard packing: Tube: 40 pcs.; Case: 1,000 pcs.

3. In case of 5 V transistor drive circuit, it is recommended to use 4.5 V type relay.

TX

2) Surface-mount terminal type

1. Single side stable

Part No.	Nominal voltage, V DC	Pick-up voltage, V DC (max.)	Drop-out voltage, V DC (min.)	Nominal operating current, mA ($\pm 10\%$)	Coil resistance, Ω ($\pm 10\%$)	Nominal operating power, mW	Max. allowable voltage, V DC
TX2SO-1.5 V	1.5	1.13	0.15	93.8	16	140	2.2
TX2SO-3 V	3	2.25	0.3	46.7	64.3	140	4.5
TX2SO-4.5 V	4.5	3.38	0.45	31	145	140	6.7
TX2SO-5 V	5	3.75	0.5	28.1	178	140	7.5
TX2SO-6 V	6	4.5	0.6	23.3	257	140	9
TX2SO-9 V	9	6.75	0.9	15.5	579	140	13.5
TX2SO-12 V	12	9	1.2	11.7	1,028	140	18
TX2SO-24 V	24	18	2.4	5.8	4,114	140	36
TX2SO-48 V	48	36	4.8	5.6	8,533	270	57.6

2. 1 coil latching

Part No.	Nominal voltage, V DC	Set voltage, V DC (max.)	Reset voltage, V DC (max.)	Nominal operating current, mA ($\pm 10\%$)	Coil resistance, Ω ($\pm 10\%$)	Nominal operating power, mW	Max. allowable voltage, V DC
TX2SO-L-1.5 V	1.5	1.13	1.13	66.7	22.5	100	2.2
TX2SO-L-3 V	3	2.25	2.25	33.3	90	100	4.5
TX2SO-L-4.5 V	4.5	3.38	3.38	22.2	202.5	100	6.7
TX2SO-L-5 V	5	3.75	3.75	20	250	100	7.5
TX2SO-L-6 V	6	4.5	4.5	16.7	360	100	9
TX2SO-L-9 V	9	6.75	6.75	11.1	810	100	13.5
TX2SO-L-12 V	12	9	9	8.3	1,440	100	18
TX2SO-L-24 V	24	18	18	4.2	5,760	100	36

3. 2 coil latching

Part No.	Nominal voltage, V DC	Set voltage, V DC (max.)	Reset voltage, V DC (max.)	Nominal operating current, mA ($\pm 10\%$)	Coil resistance, Ω ($\pm 10\%$)	Nominal operating power, mW	Max. allowable voltage, V DC
TX2SO-L2-1.5 V	1.5	1.13	1.13	133.9	11.2	200	2.2
TX2SO-L2-3 V	3	2.25	2.25	66.7	45	200	4.5
TX2SO-L2-4.5 V	4.5	3.38	3.38	44.5	101.2	200	6.7
TX2SO-L2-5 V	5	3.75	3.75	40	125	200	7.5
TX2SO-L2-6 V	6	4.5	4.5	33.3	180	200	9
TX2SO-L2-9 V	9	6.75	6.75	22.2	405	200	13.5
TX2SO-L2-12 V	12	9	9	16.7	720	200	18
TX2SO-L2-24 V	24	18	18	8.3	2,880	200	36

○: For each surface-mounted terminal variation, input the following letter.

SA type: A, SL type: L, SS type: S

Notes:

- Specified value of pick-up, drop-out, set and reset voltage is with the condition of square wave coil pulse.
- Standard packing: Tube: 40 pcs.; Case: 1,000 pcs.
- Tape and reel packing is also available for surface-mount type by request. Part number suffix "-X" or "-Z" is needed when ordering.
In this case, "X" or "Z" are not marked on the relay.
Quantity in tape and reel: 500 pcs.

(ex.) • TX2SA-3V-X

• TX2SA-L-3V-Z

└ Picked from the 1/3/4/5-pin side

└ Picked from the 8/9/10/12-pin side

- In case of 5 V transistor drive circuit, it is recommended to use 4.5 V type relay.

DIMENSIONS

1. Single side stable and 1 coil latching type

Standard PC board terminal



Self clinching terminal

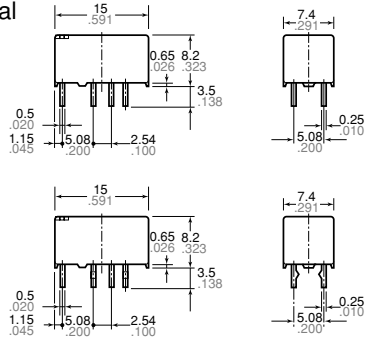

General tolerance: $\pm 0.3 \pm 0.012$

PC board pattern
(Copper-side view)

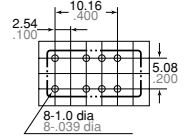

Tolerance: $\pm 0.1 \pm 0.004$

Schematic (Bottom view)
Single side stable (Deenergized condition) 1 coil latching (Reset condition)

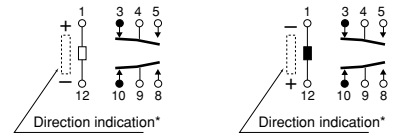

*Orientation stripe located on top of relay.

Surface-mount terminal
SA type



SL type

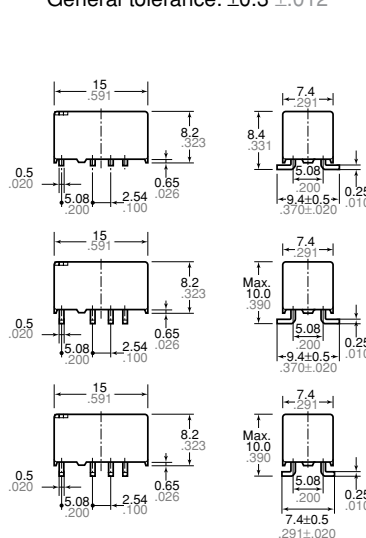

General tolerance: $\pm 0.3 \pm 0.012$

Suggested mounting pad
(Top view)

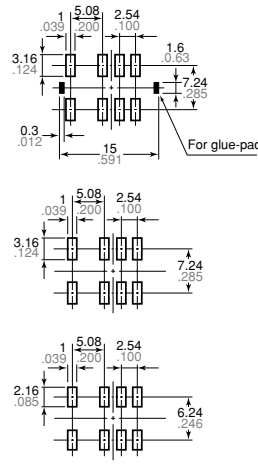

Tolerance: $\pm 0.1 \pm 0.004$

Schematic (Top view)
Single side stable (Deenergized condition) 1 coil latching (Reset condition)

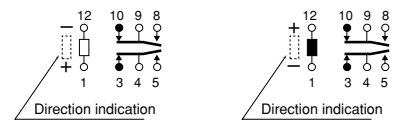

2. Coil latching type

Standard PC board terminal

Self clinching terminal

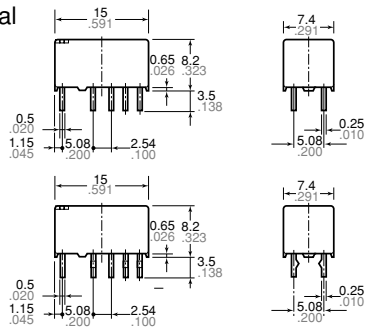

General tolerance: $\pm 0.3 \pm 0.012$

PC board pattern
(Copper side view)

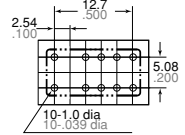

Tolerance: $\pm 0.1 \pm 0.004$

Schematic (Bottom view)
2 coil latching (Reset condition)

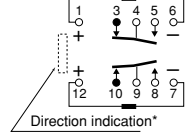

Surface-mount terminal
SA type

SL type

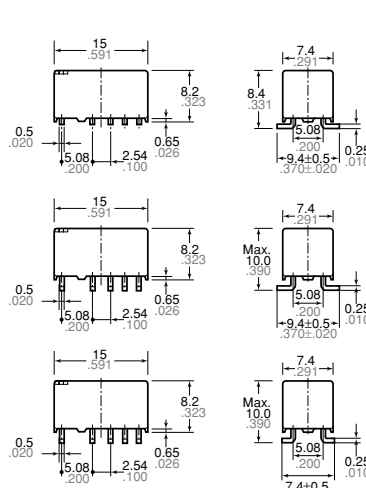

General tolerance: $\pm 0.3 \pm 0.012$

Suggested mounting pad (Top view)

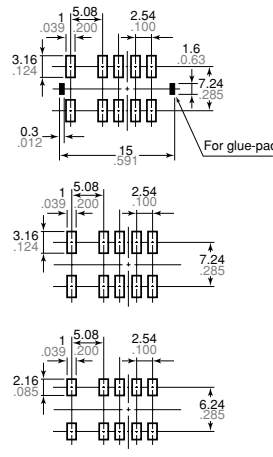

Tolerance: $\pm 0.1 \pm 0.004$

Schematic (Top view)
2 coil latching (Reset condition)

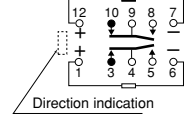

REFERENCE DATA

1. Maximum switching capacity

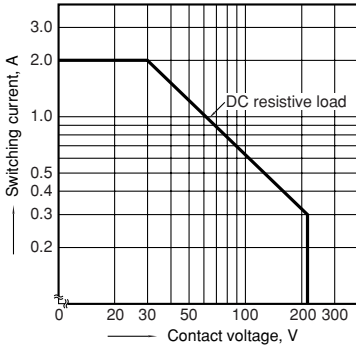

2. Life curve

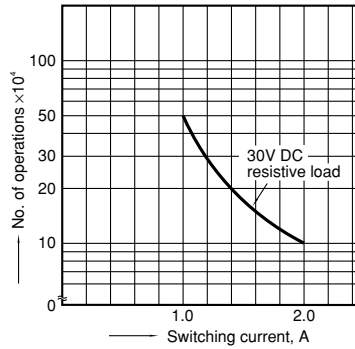

3. Mechanical life

Tested sample: TX2-5V, 10 pcs.
Operating frequency: 180 cpm

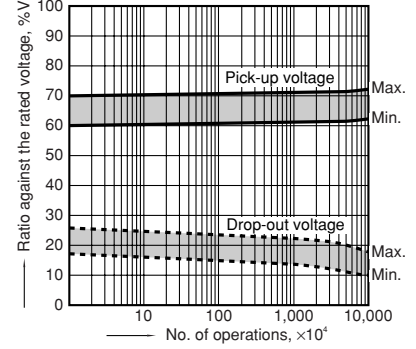

4. Electrical life

Tested sample: TX2-5V, 6 pcs.
Operating frequency: 20 cpm

Change of pick-up and drop-out voltage

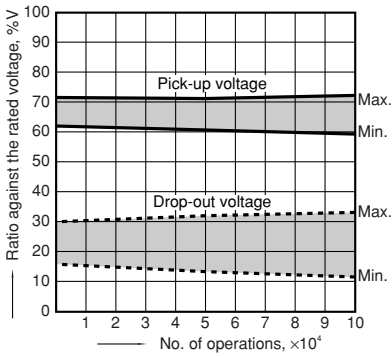

Change of contact resistance

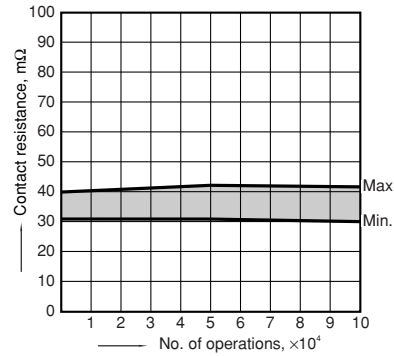

5-(1). Coil temperature rise

Tested sample: TX2-5V, 6 pcs.
Point measured: Inside the coil
Ambient temperature: 25°C 77°F, 85°C 185°F

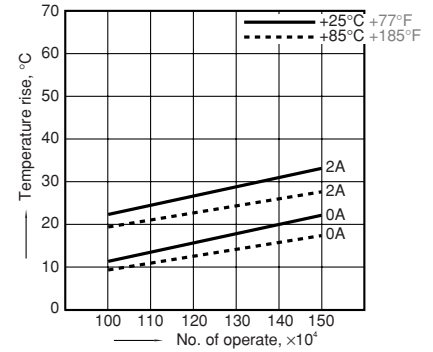

5-(2). Coil temperature rise

Tested sample: TX2-48V, 6 pcs.
Point measured: Inside the coil
Ambient temperature: 25°C 77°F, 70°C 158°F

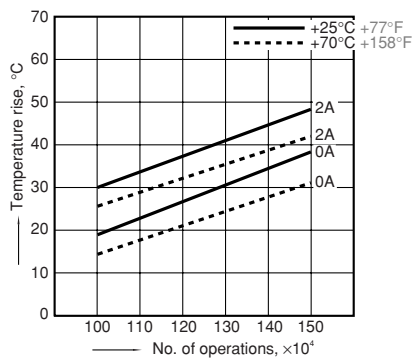

6-(1). Operate and release time (with diode)

Tested sample: TX2-5V, 10 pcs.

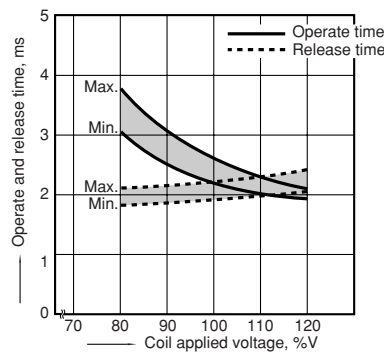

6-(2). Operate and release time (without diode)

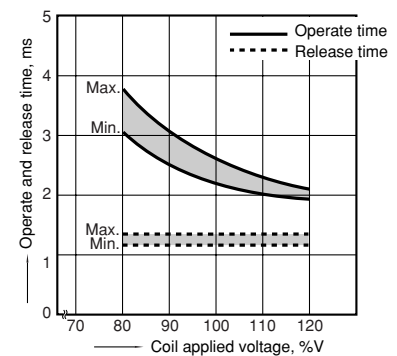

7. Distribution of pick-up and drop-out voltage

Tested sample: TX2-5V, 50 pcs.

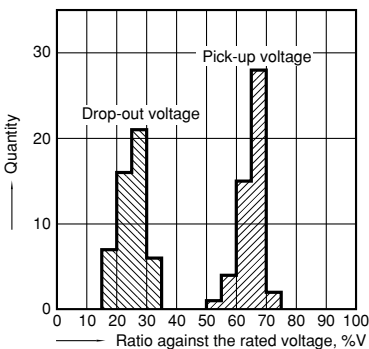

8. Distribution of set and reset voltage

Tested sample: TX2-L2-12V, 30 pcs.

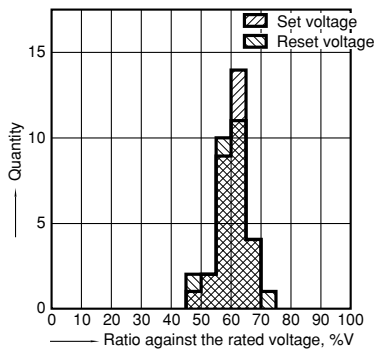

9. Ambient temperature characteristics

Tested sample: TX2-5V, 5 pcs.

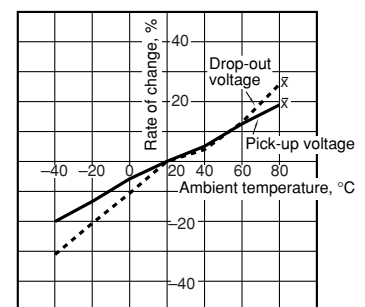

10. Distribution of contact resistance
 Tested sample: TX2-5V, 30 pcs. (30 × 4 contacts)

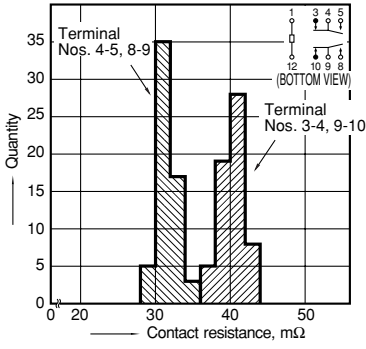

11-(1). High frequency characteristics
 Tested sample: TX2-12V, 2 pcs.
 Isolation characteristics

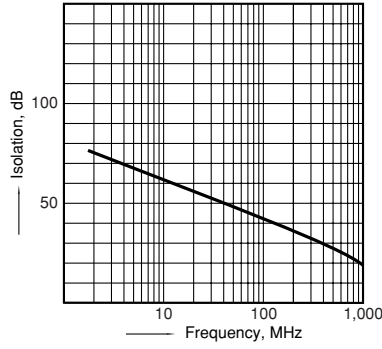

11-(2). High frequency characteristics
 Tested sample: TX2-12V, 2 pcs.
 Insertion loss characteristics

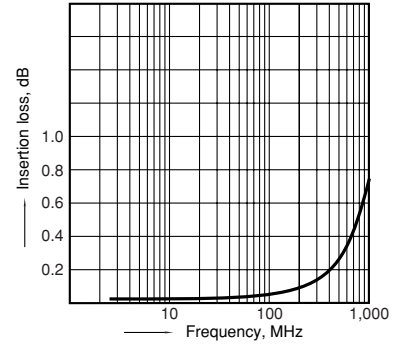

12-(1). Malfunctional shock (single side stable)
 Tested sample: TX2-5V, 6 pcs

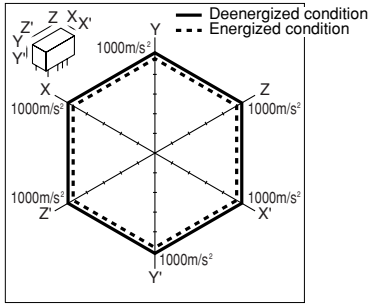

12-(2). Malfunctional shock (latching)
 Tested sample: TX2-L2-12V, 6 pcs.

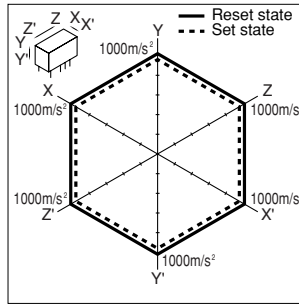

13-(1). Influence of adjacent mounting

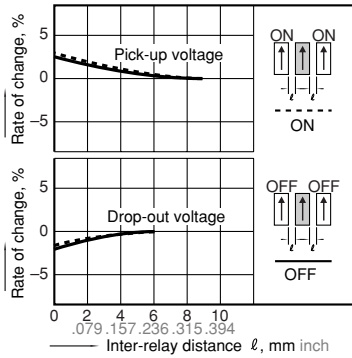

13-(2). Influence of adjacent mounting

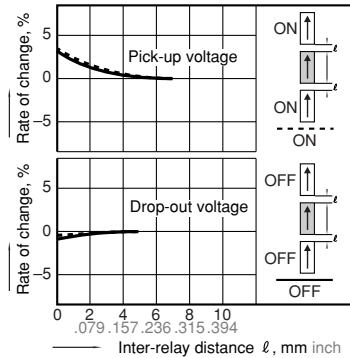

13-(3). Influence of adjacent mounting

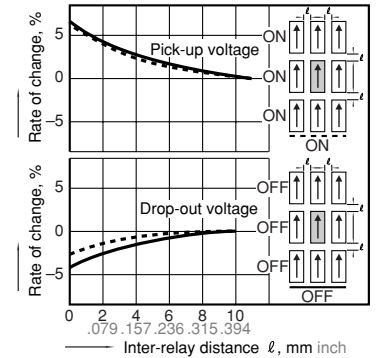

14. Pulse dialing test
 Tested sample: TX2-5V, 6 pcs.
 (35 mA 48 V DC wire spring relay load)

Circuit

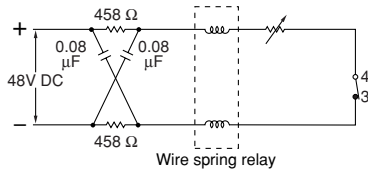

Change of pick-up and drop-out voltage

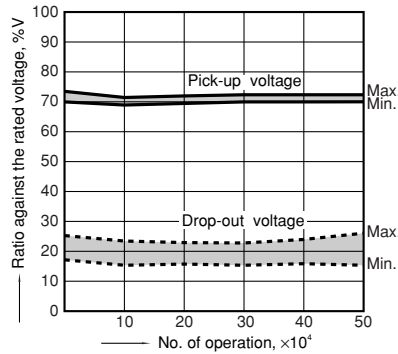

Change of contact resistance

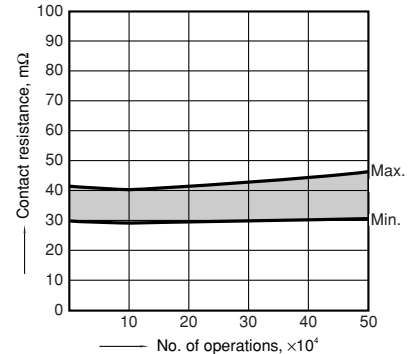

Note: Data of surface-mount type are the same as those of PC board terminal type.

TX

Notes

1. Packing style

1) The relay is packed in a tube with the relay orientation mark on the left side, as shown in the figure below.

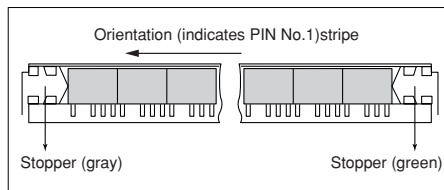

2) Tape and reel packing (surface-mount terminal type)

(1) Tape dimensions

(i) SA type

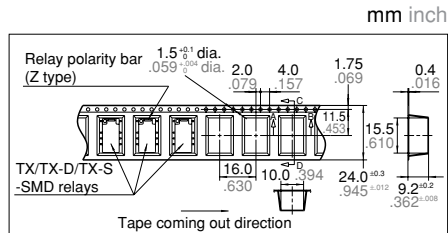

(ii) SL type

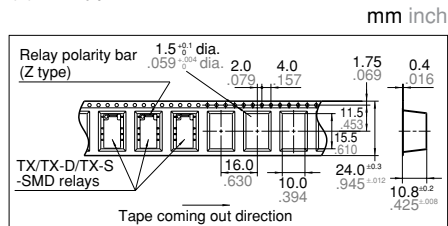

(iii) SS type

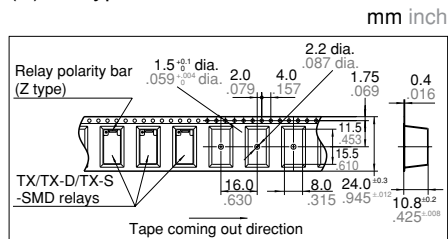

(2) Dimensions of plastic reel

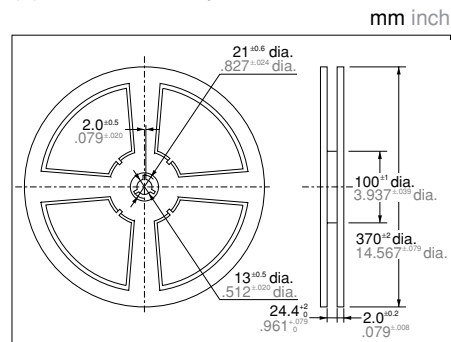

For Cautions for Use, see Relay Technical Information.