

2SK3131

Chopper Regulator DC-DC Converter and Motor Drive Applications

- Fast reverse recovery time : $t_{rr} = 105 \text{ ns (typ.)}$
- Built-in high-speed free-wheeling diode
- Low drain-source ON resistance : $R_{DS(ON)} = 0.085 \Omega \text{ (typ.)}$
- High forward transfer admittance : $|Y_{fs}| = 35 \text{ S (typ.)}$
- Low leakage current : $I_{DSS} = 100 \mu\text{A (max)}$ ($V_{DS} = 500 \text{ V}$)
- Enhancement mode : $V_{th} = 2.4\sim 3.4 \text{ V}$ ($V_{DS} = 10 \text{ V}$, $I_D = 1 \text{ mA}$)

Maximum Ratings ($T_a = 25^\circ\text{C}$)

Characteristics	Symbol	Rating	Unit
Drain-source voltage	V_{DSS}	500	V
Drain-gate voltage ($R_{GS} = 20 \text{ k}\Omega$)	V_{DGR}	500	V
Gate-source voltage	V_{GSS}	± 30	V
DC Drain current	DC (Note 1)	I_D	50 A
	Pulse (Note 1)	I_{DP}	200 A
Drain power dissipation ($T_c = 25^\circ\text{C}$)	P_D	250	W
Single pulse avalanche energy (Note 2)	E_{AS}	525	mJ
Avalanche current	I_{AR}	50	A
Repetitive avalanche energy (Note 3)	E_{AR}	25	mJ
Channel temperature	T_{ch}	150	$^\circ\text{C}$
Storage temperature range	T_{stg}	$-55\sim 150$	$^\circ\text{C}$

Thermal Characteristics

Characteristics	Symbol	Max	Unit
Thermal resistance, channel to case	$R_{th(ch-c)}$	0.5	$^\circ\text{C} / \text{W}$
Thermal resistance, channel to ambient	$R_{th(ch-a)}$	35.7	$^\circ\text{C} / \text{W}$

Note 1: Ensure that the channel temperature does not exceed 150°C .

Note 2: $V_{DD} = 90 \text{ V}$, $T_{ch} = 25^\circ\text{C}$ (initial), $L = 357 \mu\text{H}$, $R_G = 25 \Omega$, $I_{AR} = 50 \text{ A}$

Note 3: Repetitive rating: pulse width limited by maximum channel temperature.

This transistor is an electrostatic-sensitive device.
Please handle with caution.

Unit: mm

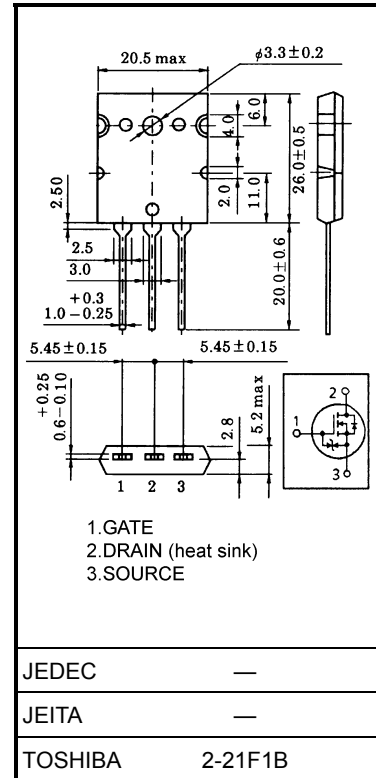

Weight: 9.75 g (typ.)

Electrical Characteristics (Ta = 25°C)

Characteristics		Symbol	Test Condition	Min	Typ.	Max	Unit
Gate leakage current		I_{GSS}	$V_{GS} = \pm 25\text{ V}, V_{DS} = 0\text{ V}$	—	—	± 10	μA
Gate-source breakdown voltage		$V_{(BR)GSS}$	$I_G = \pm 100\ \mu\text{A}, V_{DS} = 0\text{ V}$	± 30	—	—	V
Drain cut-off current		I_{DSS}	$V_{DS} = 500\text{ V}, V_{GS} = 0\text{ V}$	—	—	100	μA
Drain-source breakdown voltage		$V_{(BR)DSS}$	$I_D = 10\text{ mA}, V_{GS} = 0\text{ V}$	500	—	—	V
Gate threshold voltage		V_{th}	$V_{DS} = 10\text{ V}, I_D = 1\text{ mA}$	2.4	—	3.4	V
Drain-source ON resistance		$R_{DS(ON)}$	$V_{GS} = 10\text{ V}, I_D = 25\text{ A}$	—	0.085	0.11	Ω
Forward transfer admittance		$ Y_{fs} $	$V_{DS} = 10\text{ V}, I_D = 25\text{ A}$	15	35	—	S
Input capacitance		C_{iss}	$V_{DS} = 10\text{ V}, V_{GS} = 0\text{ V}, f = 1\text{ MHz}$	—	11000	—	pF
Reverse transfer capacitance		C_{rss}		—	2100	—	
Output capacitance		C_{oss}		—	4200	—	
Switching time	Rise time	t_r	<p>$I_D = 25\text{ A}$ $V_{GS} = 10\text{ V}, 0\text{ V}$ $4.7\ \Omega$ $7\ \Omega$ $R_L = 8\ \Omega$ $V_{DD} = 200\text{ V}$ V_{OUT} Duty $\leq 1\%$, $t_w = 10\ \mu\text{s}$</p>	—	105	—	ns
	Turn-on time	t_{on}		—	160	—	
	Fall time	t_f		—	65	—	
	Turn-off time	t_{off}		—	245	—	
Total gate charge (Gate-source plus gate-drain)		Q_g	$V_{DD} \approx 400\text{ V}, V_{GS} = 10\text{ V}, I_D = 50\text{ A}$	—	280	—	nC
Gate-source charge		Q_{gs}		—	150	—	
Gate-drain ("miller") charge		Q_{gd}		—	130	—	

Source-Drain Ratings and Characteristics (Ta = 25°C)

Characteristics	Symbol	Test Condition	Min	Typ.	Max	Unit
Continuous drain reverse current (Note 1)	I_{DR}	—	—	—	50	A
Pulse drain reverse current (Note 1)	I_{DRP}	—	—	—	200	A
Forward voltage (diode)	V_{DSF}	$V_{DR} = 25\text{ A}, V_{GS} = 0\text{ V}$	—	—	-1.7	V
Reverse recovery time	t_{rr}	$I_{DR} = 50\text{ A}, V_{GS} = 0\text{ V}$	—	105	—	ns
Reverse recovery charge	Q_{rr}	$dI_{DR} / dt = 100\text{ A} / \mu\text{s}$	—	380	—	nC

Marking

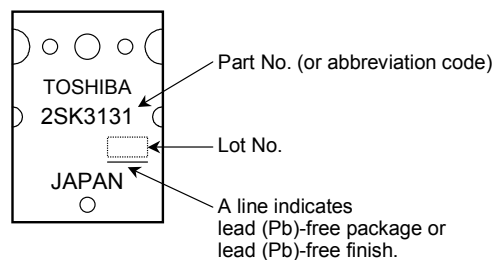

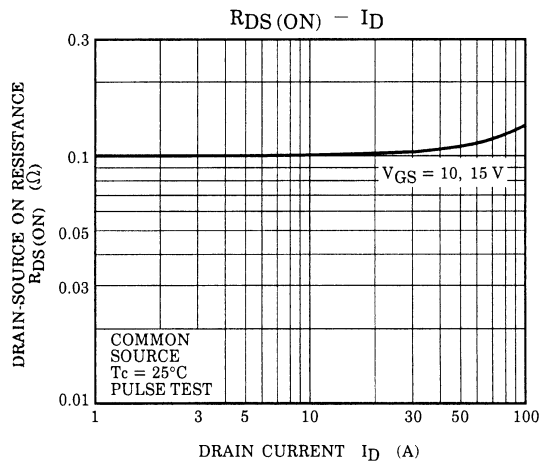
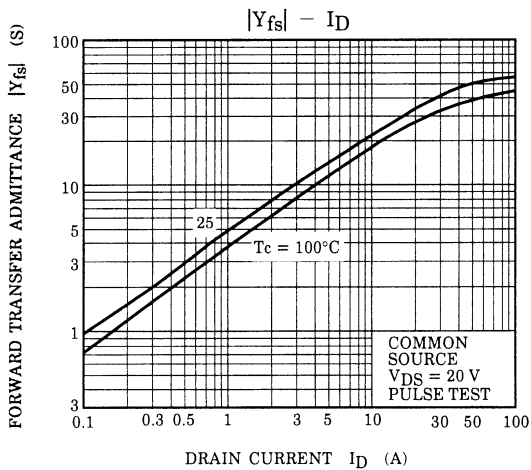
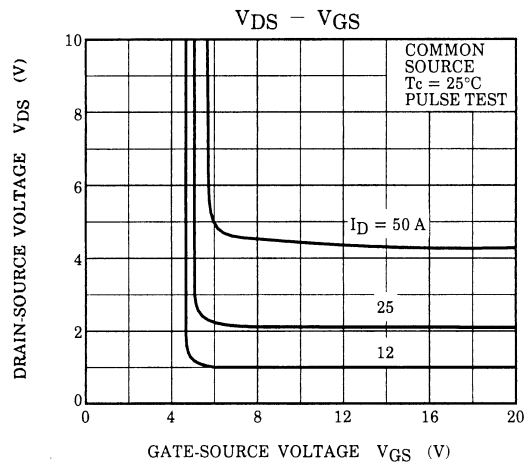
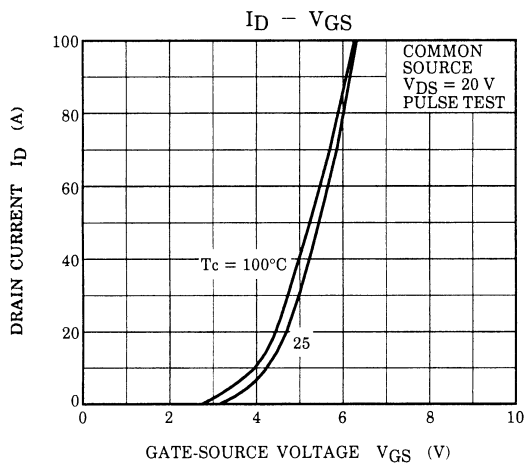
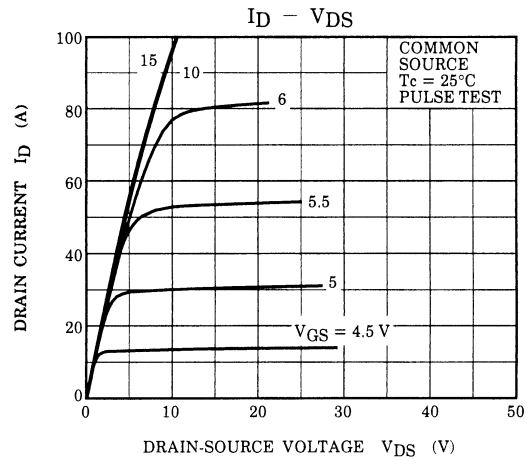
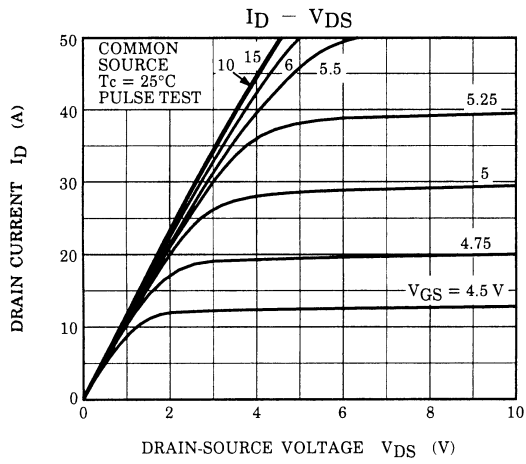

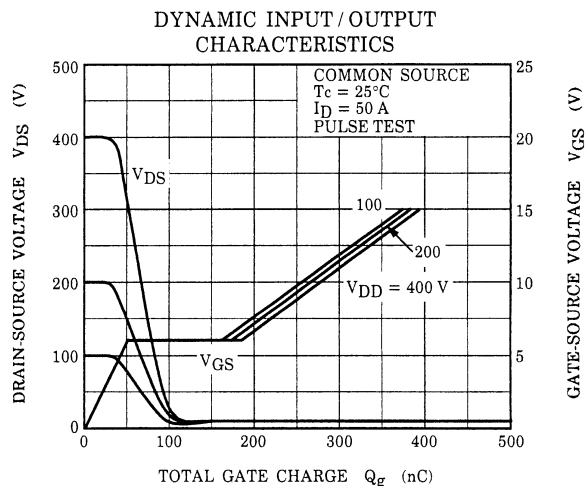
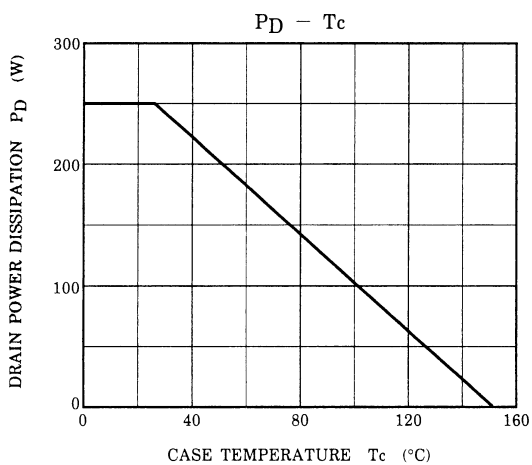
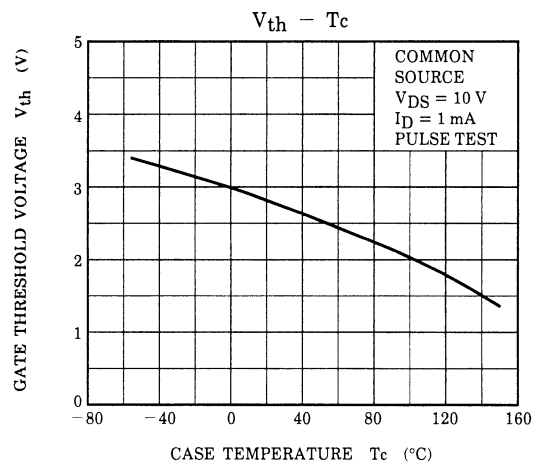
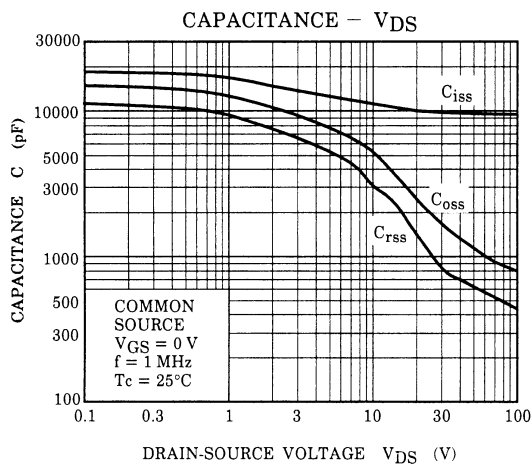
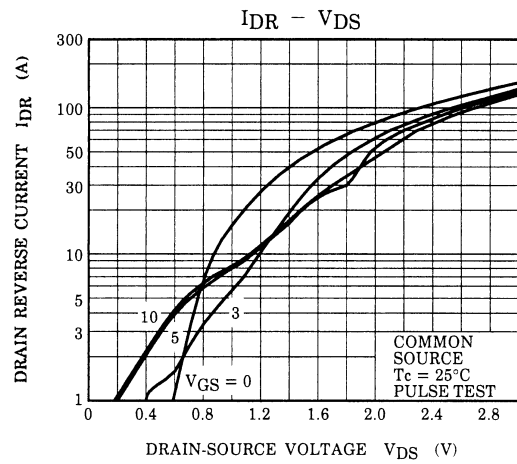
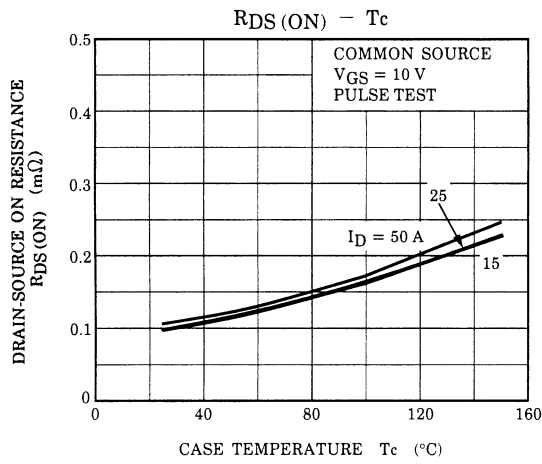

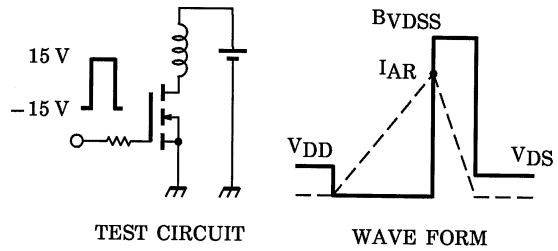
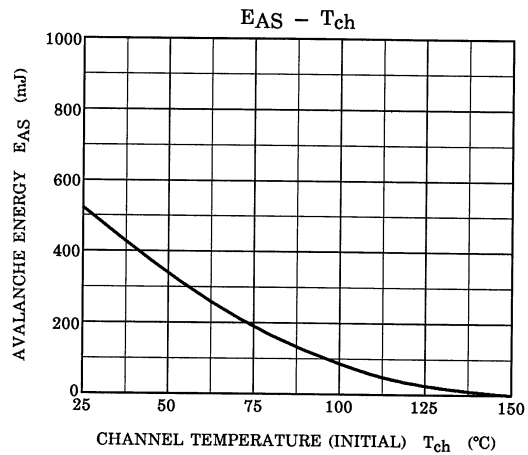
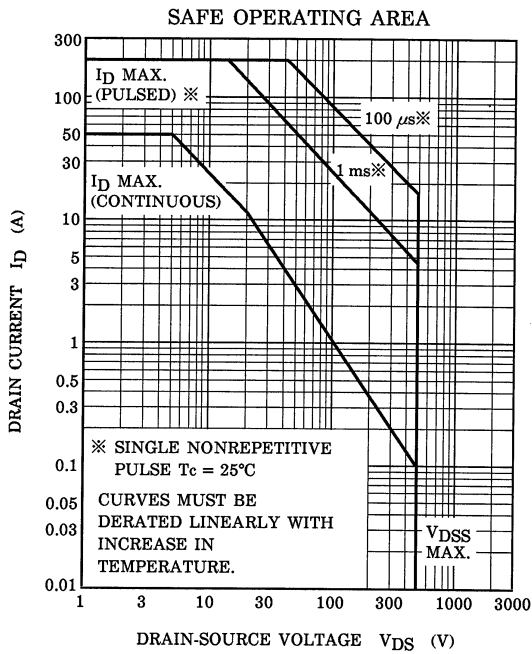
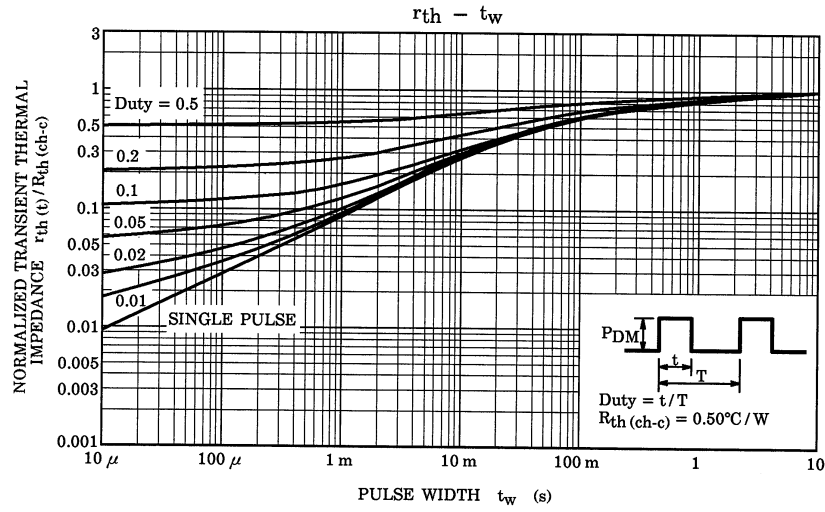

$R_G = 25 \Omega$
 $V_{DD} = 90 V, L = 357 \mu H$

$$E_{AS} = \frac{1}{2} \cdot L \cdot I_{AR}^2 \cdot \left(\frac{BVDSS}{BVDSS - V_{DD}} \right)$$

RESTRICTIONS ON PRODUCT USE

030619EAA

- The information contained herein is subject to change without notice.
- The information contained herein is presented only as a guide for the applications of our products. No responsibility is assumed by TOSHIBA for any infringements of patents or other rights of the third parties which may result from its use. No license is granted by implication or otherwise under any patent or patent rights of TOSHIBA or others.
- TOSHIBA is continually working to improve the quality and reliability of its products. Nevertheless, semiconductor devices in general can malfunction or fail due to their inherent electrical sensitivity and vulnerability to physical stress. It is the responsibility of the buyer, when utilizing TOSHIBA products, to comply with the standards of safety in making a safe design for the entire system, and to avoid situations in which a malfunction or failure of such TOSHIBA products could cause loss of human life, bodily injury or damage to property.
In developing your designs, please ensure that TOSHIBA products are used within specified operating ranges as set forth in the most recent TOSHIBA products specifications. Also, please keep in mind the precautions and conditions set forth in the "Handling Guide for Semiconductor Devices," or "TOSHIBA Semiconductor Reliability Handbook" etc..
- The TOSHIBA products listed in this document are intended for usage in general electronics applications (computer, personal equipment, office equipment, measuring equipment, industrial robotics, domestic appliances, etc.). These TOSHIBA products are neither intended nor warranted for usage in equipment that requires extraordinarily high quality and/or reliability or a malfunction or failure of which may cause loss of human life or bodily injury ("Unintended Usage"). Unintended Usage include atomic energy control instruments, airplane or spaceship instruments, transportation instruments, traffic signal instruments, combustion control instruments, medical instruments, all types of safety devices, etc.. Unintended Usage of TOSHIBA products listed in this document shall be made at the customer's own risk.
- TOSHIBA products should not be embedded to the downstream products which are prohibited to be produced and sold, under any law and regulations.