

# Designer's™ Data Sheet

## Insulated Gate Bipolar Transistor with Anti-Parallel Diode

### N-Channel Enhancement-Mode Silicon Gate

**MGW20N60D**  
Motorola Preferred Device

IGBT & DIODE IN TO-247  
20 A @ 90°C  
32 A @ 25°C  
600 VOLTS  
SHORT CIRCUIT RATED

This Insulated Gate Bipolar Transistor (IGBT) is co-packaged with a soft recovery ultra-fast rectifier and uses an advanced termination scheme to provide an enhanced and reliable high voltage-blocking capability. Short circuit rated IGBT's are specifically suited for applications requiring a guaranteed short circuit withstand time such as Motor Control Drives. Fast switching characteristics result in efficient operations at high frequencies. Co-packaged IGBT's save space, reduce assembly time and cost.

- Industry Standard High Power TO-247 Package with Isolated Mounting Hole
- High Speed  $E_{off}$ : 60  $\mu$ J per Amp typical at 125°C
- High Short Circuit Capability – 10  $\mu$ s minimum
- Soft Recovery Free Wheeling Diode is included in the package
- Robust High Voltage Termination
- Robust RBSOA

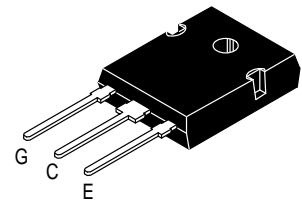
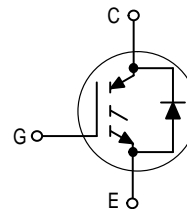

CASE 340F-03, Style 4  
TO-247AE

**MAXIMUM RATINGS** ( $T_C = 25^\circ\text{C}$  unless otherwise noted)

Rating	Symbol	Value	Unit
Collector-Emitter Voltage	$V_{CES}$	600	Vdc
Collector-Gate Voltage ( $R_{GE} = 1.0 \text{ M}\Omega$ )	$V_{CGR}$	600	Vdc
Gate-Emitter Voltage — Continuous	$V_{GE}$	$\pm 20$	Vdc
Collector Current — Continuous @ $T_C = 25^\circ\text{C}$ — Continuous @ $T_C = 90^\circ\text{C}$ — Repetitive Pulsed Current (1)	$I_{C25}$ $I_{C90}$ $I_{CM}$	32 20 64	Adc Apk
Total Power Dissipation @ $T_C = 25^\circ\text{C}$ Derate above 25°C	$P_D$	142 1.14	Watts W/°C
Operating and Storage Junction Temperature Range	$T_J, T_{stg}$	-55 to 150	°C
Short Circuit Withstand Time ( $V_{CC} = 360 \text{ Vdc}$ , $V_{GE} = 15 \text{ Vdc}$ , $T_J = 25^\circ\text{C}$ , $R_G = 20 \Omega$ )	$t_{sc}$	10	$\mu$ s
Thermal Resistance — Junction to Case – IGBT — Junction to Case – Diode — Junction to Ambient	$R_{\theta JC}$ $R_{\theta Jc}$ $R_{\theta JA}$	0.88 2.00 45	°C/W
Maximum Lead Temperature for Soldering Purposes, 1/8" from case for 5 seconds	$T_L$	260	°C
Mounting Torque, 6-32 or M3 screw	10 lbf•in (1.13 N•m)		

(1) Pulse width is limited by maximum junction temperature.

**Designer's Data for "Worst Case" Conditions** — The Designer's Data Sheet permits the design of most circuits entirely from the information presented. SOA Limit curves — representing boundaries on device characteristics — are given to facilitate "worst case" design.

**Preferred** devices are Motorola recommended choices for future use and best overall value.

# MGW20N60D

## ELECTRICAL CHARACTERISTICS (T<sub>J</sub> = 25°C unless otherwise noted)

Characteristic	Symbol	Min	Typ	Max	Unit
<b>OFF CHARACTERISTICS</b>					
Collector-to-Emitter Breakdown Voltage (V <sub>GE</sub> = 0 Vdc, I <sub>C</sub> = 250 μAdc) Temperature Coefficient (Positive)	BV <sub>CES</sub>	600 —	— 870	— —	Vdc mV/°C
Zero Gate Voltage Collector Current (V <sub>CE</sub> = 600 Vdc, V <sub>GE</sub> = 0 Vdc) (V <sub>CE</sub> = 600 Vdc, V <sub>GE</sub> = 0 Vdc, T <sub>J</sub> = 125°C)	I <sub>CES</sub>	— —	— —	100 2500	μAdc
Gate-Body Leakage Current (V <sub>GE</sub> = ± 20 Vdc, V <sub>CE</sub> = 0 Vdc)	I <sub>GES</sub>	—	—	250	nAdc

## ON CHARACTERISTICS (1)

Collector-to-Emitter On-State Voltage (V <sub>GE</sub> = 15 Vdc, I <sub>C</sub> = 10 Adc) (V <sub>GE</sub> = 15 Vdc, I <sub>C</sub> = 10 Adc, T <sub>J</sub> = 125°C) (V <sub>GE</sub> = 15 Vdc, I <sub>C</sub> = 20 Adc)	V <sub>CE(on)</sub>	— — —	2.30 2.20 2.85	2.85 — 3.65	Vdc
Gate Threshold Voltage (V <sub>CE</sub> = V <sub>GE</sub> , I <sub>C</sub> = 1 mAdc) Threshold Temperature Coefficient (Negative)	V <sub>GE(th)</sub>	4.0 —	6.0 10	8.0 —	Vdc mV/°C
Forward Transconductance (V <sub>CE</sub> = 10 Vdc, I <sub>C</sub> = 20 Adc)	g <sub>fe</sub>	—	12	—	Mhos

## DYNAMIC CHARACTERISTICS

Input Capacitance	(V <sub>CE</sub> = 25 Vdc, V <sub>GE</sub> = 0 Vdc, f = 1.0 MHz)	C <sub>ies</sub>	—	2280	—	pF
Output Capacitance		C <sub>oes</sub>	—	165	—	
Transfer Capacitance		C <sub>res</sub>	—	12	—	

## SWITCHING CHARACTERISTICS (1)

Turn-On Delay Time	(V <sub>CC</sub> = 360 Vdc, I <sub>C</sub> = 20 Adc, V <sub>GE</sub> = 15 Vdc, L = 300 μH R <sub>G</sub> = 20 Ω, T <sub>J</sub> = 25°C) Energy losses include "tail"	t <sub>d(on)</sub>	—	59	—	ns
Rise Time		t <sub>r</sub>	—	61	—	
Turn-Off Delay Time		t <sub>d(off)</sub>	—	150	—	
Fall Time		t <sub>f</sub>	—	212	—	mJ
Turn-Off Switching Loss		E <sub>off</sub>	—	0.60	0.85	
Turn-On Switching Loss		E <sub>on</sub>	—	0.75	—	
Total Switching Loss		E <sub>ts</sub>	—	1.35	—	
Turn-On Delay Time	(V <sub>CC</sub> = 360 Vdc, I <sub>C</sub> = 20 Adc, V <sub>GE</sub> = 15 Vdc, L = 300 μH R <sub>G</sub> = 20 Ω, T <sub>J</sub> = 125°C) Energy losses include "tail"	t <sub>d(on)</sub>	—	51	—	ns
Rise Time		t <sub>r</sub>	—	77	—	
Turn-Off Delay Time		t <sub>d(off)</sub>	—	184	—	
Fall Time		t <sub>f</sub>	—	392	—	mJ
Turn-Off Switching Loss		E <sub>off</sub>	—	1.20	—	
Turn-On Switching Loss		E <sub>on</sub>	—	1.50	—	
Total Switching Loss		E <sub>ts</sub>	—	2.70	—	
Gate Charge	(V <sub>CC</sub> = 360 Vdc, I <sub>C</sub> = 20 Adc, V <sub>GE</sub> = 15 Vdc)	Q <sub>T</sub>	—	74	—	nC
		Q <sub>1</sub>	—	19	—	
		Q <sub>2</sub>	—	27	—	

## DIODE CHARACTERISTICS

Diode Forward Voltage Drop (I <sub>EC</sub> = 10 Adc) (I <sub>EC</sub> = 10 Adc, T <sub>J</sub> = 125°C) (I <sub>EC</sub> = 20 Adc)	V <sub>FEC</sub>	— — —	1.50 1.30 1.70	1.90 — 2.15	Vdc
--	------------------	-------------	----------------------	-------------------	-----

(1) Pulse Test: Pulse Width ≤ 300 μs, Duty Cycle ≤ 2%.

(continued)

**ELECTRICAL CHARACTERISTICS — continued** ( $T_J = 25^\circ\text{C}$  unless otherwise noted)

Characteristic	Symbol	Min	Typ	Max	Unit		
<b>DIODE CHARACTERISTICS — continued</b>							
Reverse Recovery Time	$(I_F = 20 \text{ Adc}, V_R = 360 \text{ Vdc}, dI_F/dt = 200 \text{ A}/\mu\text{s})$	$t_{rr}$	—	117	—	ns	
		$t_a$	—	70	—		
		$t_b$	—	47	—		
Reverse Recovery Stored Charge			$Q_{RR}$	—	1.2	—	$\mu\text{C}$
Reverse Recovery Time	$(I_F = 20 \text{ Adc}, V_R = 360 \text{ Vdc}, dI_F/dt = 200 \text{ A}/\mu\text{s}, T_J = 125^\circ\text{C})$	$t_{rr}$	—	166	—	ns	
		$t_a$	—	98	—		
		$t_b$	—	68	—		
Reverse Recovery Stored Charge			$Q_{RR}$	—	1.9	—	$\mu\text{C}$
<b>INTERNAL PACKAGE INDUCTANCE</b>							
Internal Emitter Inductance (Measured from the emitter lead 0.25" from package to emitter bond pad)	$L_E$	—	13	—	nH		

**TYPICAL ELECTRICAL CHARACTERISTICS**

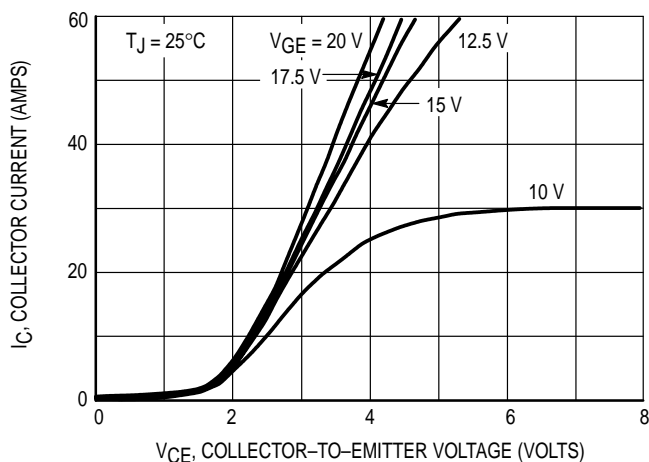

Figure 1. Output Characteristics,  $T_J = 25^\circ\text{C}$

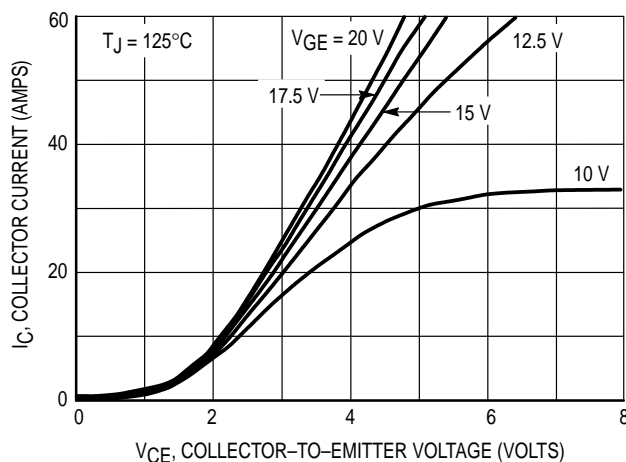

Figure 2. Output Characteristics,  $T_J = 125^\circ\text{C}$

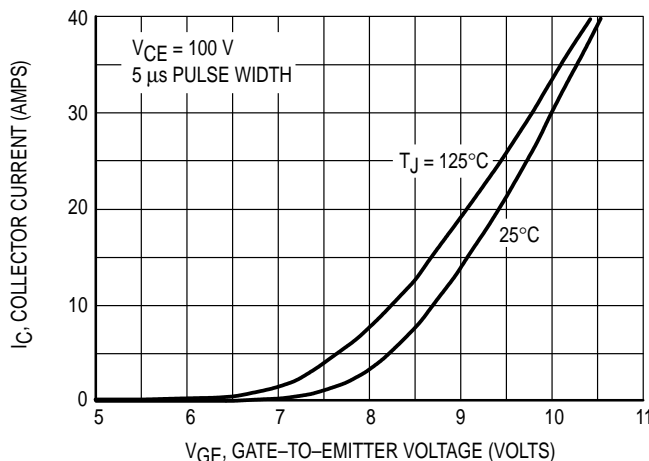

Figure 3. Transfer Characteristics

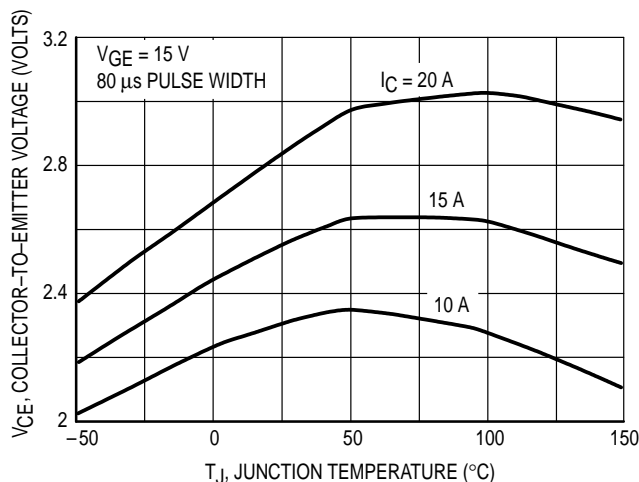
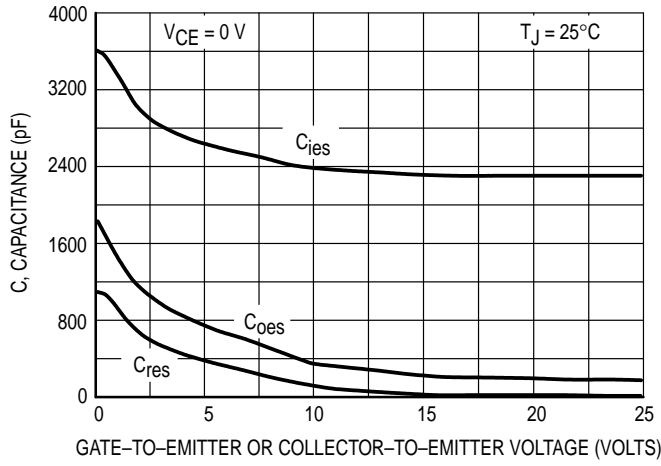
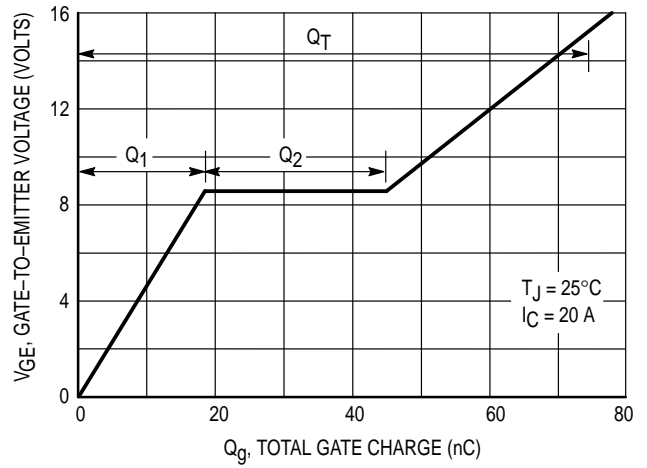

Figure 4. Collector-to-Emitter Saturation Voltage versus Junction Temperature

# MGW20N60D



**Figure 5. Capacitance Variation**



**Figure 6. Gate-to-Emitter Voltage versus Total Charge**

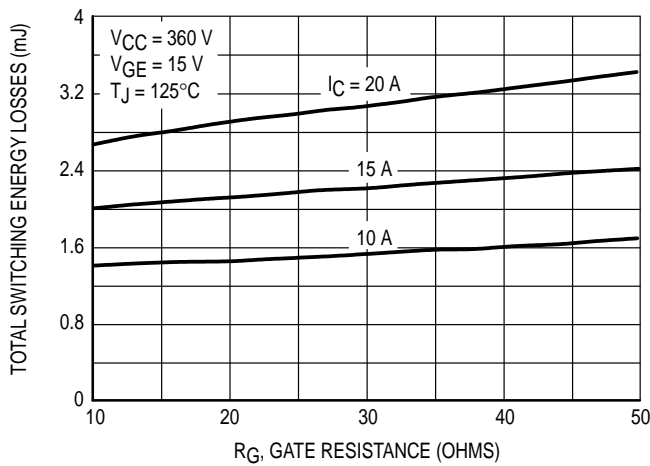

**Figure 7. Total Switching Losses versus Gate Resistance**

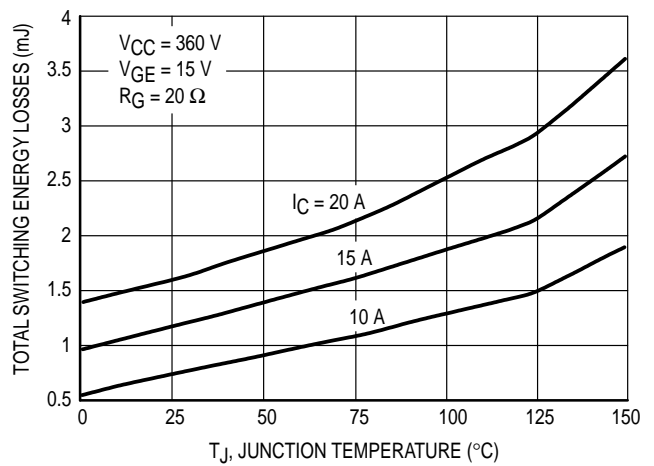

**Figure 8. Total Switching Losses versus Junction Temperature**

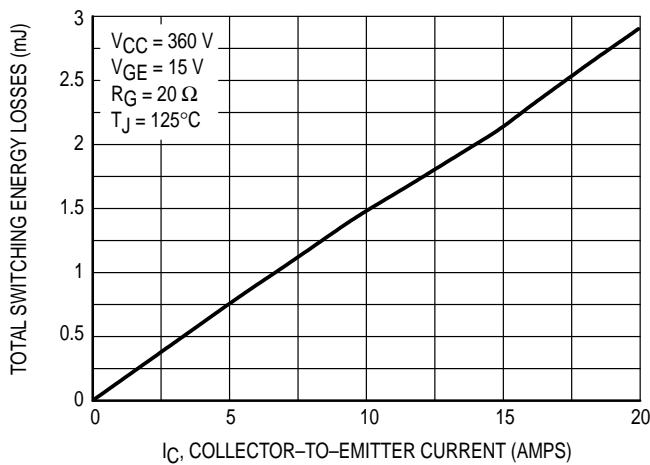

**Figure 9. Total Switching Losses versus Collector-to-Emitter Current**

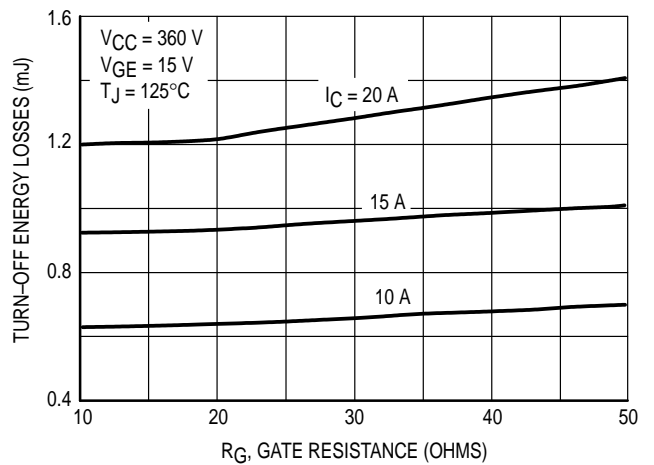

**Figure 10. Turn-Off Losses versus Gate Resistance**

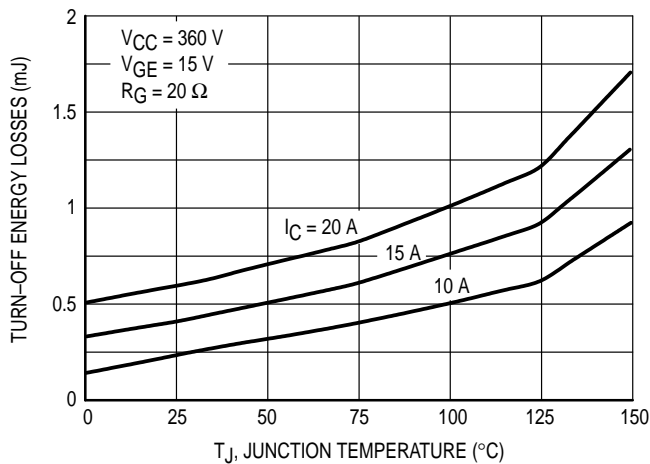

Figure 11. Turn-Off Losses versus Junction Temperature

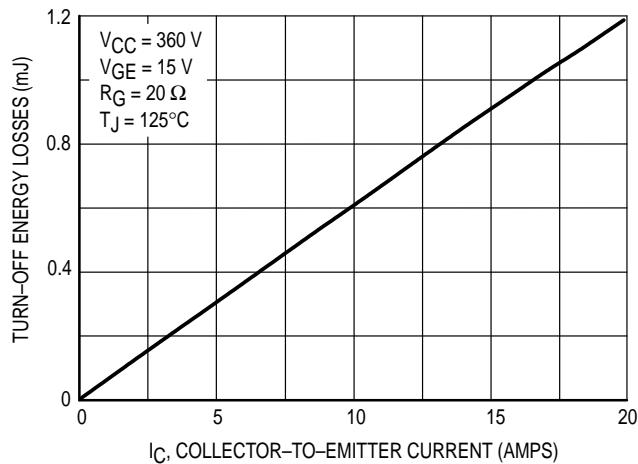

Figure 12. Turn-Off Losses versus Collector-to-Emitter Current

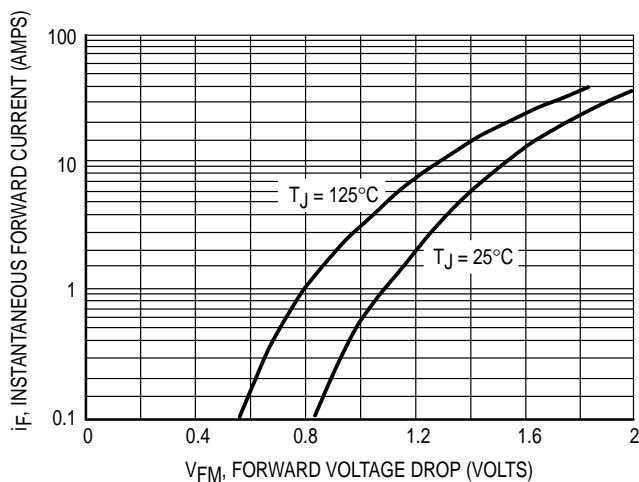

Figure 13. Typical Diode Forward Drop versus Instantaneous Forward Current

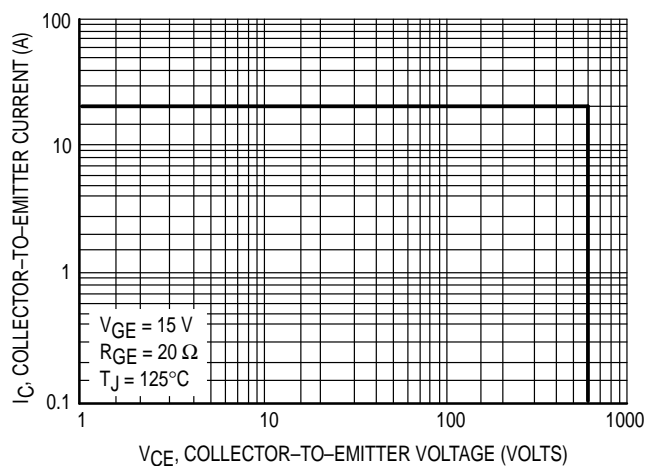
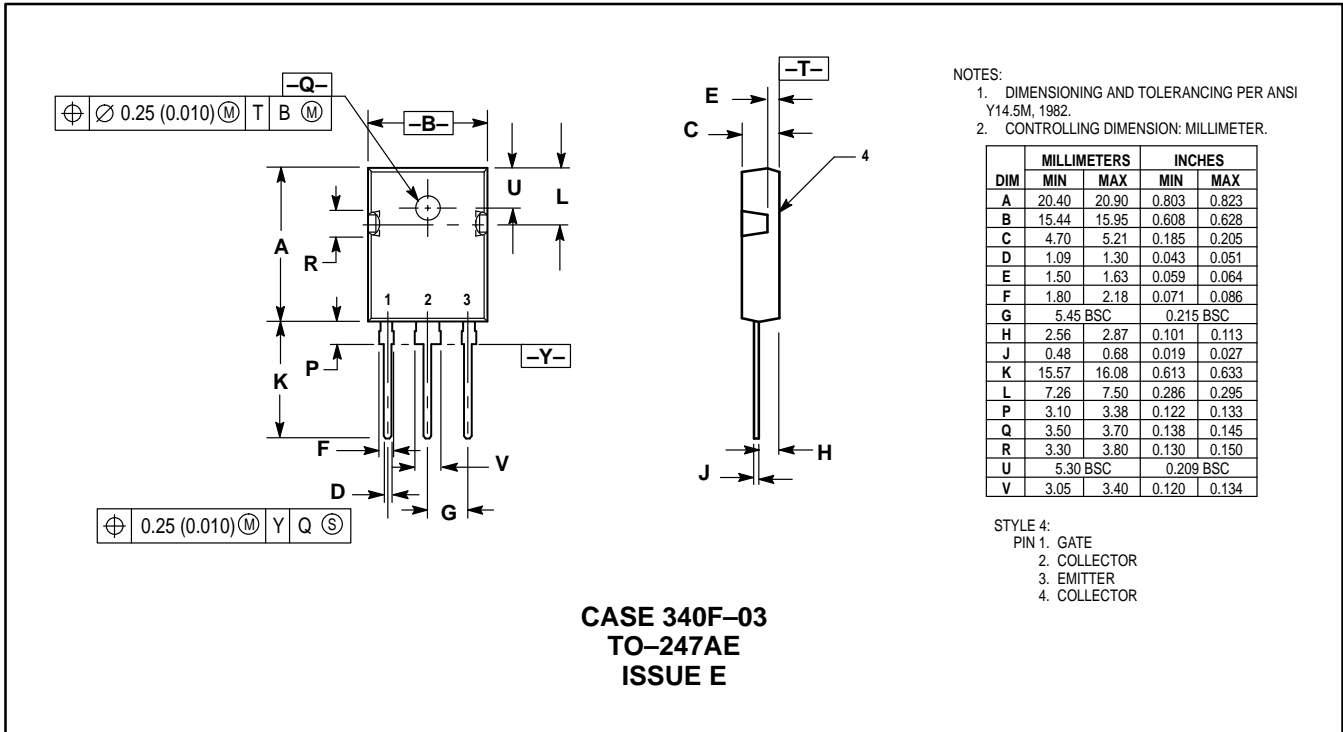

Figure 14. Reverse Biased Safe Operating Area

PACKAGE DIMENSIONS



Motorola reserves the right to make changes without further notice to any products herein. Motorola makes no warranty, representation or guarantee regarding the suitability of its products for any particular purpose, nor does Motorola assume any liability arising out of the application or use of any product or circuit, and specifically disclaims any and all liability, including without limitation consequential or incidental damages. "Typical" parameters which may be provided in Motorola data sheets and/or specifications can and do vary in different applications and actual performance may vary over time. All operating parameters, including "Typicals" must be validated for each customer application by customer's technical experts. Motorola does not convey any license under its patent rights nor the rights of others. Motorola products are not designed, intended, or authorized for use as components in systems intended for surgical implant into the body, or other applications intended to support or sustain life, or for any other application in which the failure of the Motorola product could create a situation where personal injury or death may occur. Should Buyer purchase or use Motorola products for any such unintended or unauthorized application, Buyer shall indemnify and hold Motorola and its officers, employees, subsidiaries, affiliates, and distributors harmless against all claims, costs, damages, and expenses, and reasonable attorney fees arising out of, directly or indirectly, any claim of personal injury or death associated with such unintended or unauthorized use, even if such claim alleges that Motorola was negligent regarding the design or manufacture of the part. Motorola and are registered trademarks of Motorola, Inc. Motorola, Inc. is an Equal Opportunity/Affirmative Action Employer.

How to reach us:

**USA/EUROPE/Locations Not Listed:** Motorola Literature Distribution; P.O. Box 20912; Phoenix, Arizona 85036. 1-800-441-2447 or 602-303-5454

**JAPAN:** Nippon Motorola Ltd.; Tatsumi-SPD-JLDC, 6F Seibu-Butsuryu-Center, 3-14-2 Tatsumi Koto-Ku, Tokyo 135, Japan. 03-81-3521-8315

**MFAX:** RMFAX0@email.sps.mot.com – TOUCHTONE 602-244-6609  
**INTERNET:** http://Design-NET.com

**ASIA/PACIFIC:** Motorola Semiconductors H.K. Ltd.; 8B Tai Ping Industrial Park, 51 Ting Kok Road, Tai Po, N.T., Hong Kong. 852-26629298

