

**A Series | Mitsubishi | A0 | A1 | A2 | A3
In Stock | There Tomorrow | RyansElectric.com**

Mitsubishi

MELSEC - A Series Platform



Presented by - RYANS Electric and Supply Company, Inc.

For Product Needs:

Email: sales@RyansElectric.com

CALL: **1-800-601-0896**

FAX: **1-336-855-7415**

[Check out a partial listing of products we carry at http://www.RyansElectric.com](http://www.RyansElectric.com)

MITSUBISHI

PROGRAMMABLE CONTROLLERS

MELSEC QnA/A



Mitsubishi Electric Corporation Nagoya Works is a factory certified for ISO14001 (standards for environmental management systems) and ISO9001 (standards for quality assurance management systems)



Function, Performance, L

A superior combination for a su

Flexible network configurations, powerful programming tools, and a wide product range make the QnA/A series the right choice for every level of factory automation.





Flexibility: superior product

make
of

Contents

A Unit for Every Application Need	3
QnA Series CPUs	4
A Series CPUs	5
QnA CPU Features	7
A CPU Features	8
Q4ARCPU Redundancy	9
CPU Base Units and Cables	13
Power Supplies and Memory Modules	14
Input Modules	15
Output Modules	16
Analog Modules	17
Positioning Modules	21
High Speed Counter Modules	25
Ultrasonic Linear Scale Interface Module	26
Intelligent Communication Module	27
Parallel Interface Module	28
Interrupt Module	29
System Monitor Modules	30
MELSECNET/10	31
MELSECNET/II•B	33
CC-Link	35
MELSECNET/MINI-S3	43
MELSECNET I/O Link	45
QnA Series Ethernet Modules	47
A Series Ethernet Interface Modules	48
QnA Series Communication Modules	49
A Series Communication Modules	50
PROFIBUS Interface Modules	51
DEVICENET Interface Modules	52
MODBUS Interface Modules	53
PC Option Boards	54
Programming Units	55
Modem Interface Modules	56
Programming Software	57
Human Machine Interface	60
Standards and Dimensions	61
Product Listing	63

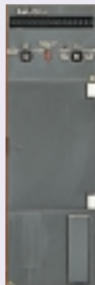
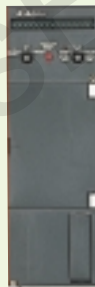
A Unit for Every Application Need

Series name	Picture	CPU type	Features	I/O points	Memory capacity (k step)
QnA		Q4ARCPU Q4ACPU Q3ACPU Q2ACPU-S1 Q2ACPU	High performance, multi-function CPU With new developments such as multiple program sequencing and global and local devices along with a bevy of new commands for special function modules, the QnACPU is the perfect solution for a wide range of factory automation needs.	4096 4096 2048 1024 512	124 124 92 60 28
AnU		A4UCPU A3UCPU A2UCPU-S1 A2UCPU	Building on the strength of the AnA series A perfect match for large scale systems, this series has the enhanced networking capabilities of MELSECNET/10 and is capable of advanced data manipulation tasks with an extended device range.	4096 2048 1024 512	30×4 30×2 14 14
AnA		A3ACPU A2ACPU-S1 A2ACPU	Incorporating the world's first microprocessor developed for sequence control applications A high level performer with a lightning fast processing speed and an easy method for configuring even the most complicated control systems. What's more, the AnA CPU system can readily handle both MELSECNET and MELSECNET II.	2048 1024 512	30×2 14 14
AnN		A3NCPU A2NCPU-S1 A2NCPU A1NCPU	The backbone of the MELSEC A family A truly general purpose PLC whose high levels of performance make it suitable to all types of PLC application, including MELSECNET functions, factory floor control, and machine control.	2048 1024 512 256	30×2 14 14 6

QnA Series CPUs

■ Specifications of QnA/Q4ARCPU

Item		Q4ARCPU	Q4ACPU	Q3ACPU	Q2ACPU-S1	Q2ACPU
Control method		Repeated operation using stored programs				
I/O control method		Refresh (direct access command provided)				
Program language		List, Ladder, SFC				
Max. I/O capacity	Local I/O	4096		2048	1024	512
	Incl. remote			8192		
Program size	Capacity	124		92	60	28
	No. of modules	124		92	60	28
No. of commands		additional 47		Sequence: 39, Other: 722		
Processing speed	LD (μs)	0.075		0.15	0.20	0.20
	MOV (μs)	0.225		0.45	0.60	0.60
Device memory (point)	Total	Total approx. 30k words (Each device range listed below can be changed)				
	Bit devices	X: 8k (Input) Y: 8k (Output) M: 8k (Internal relay) L: 8k (Latch relay) S: 8k (Step relay)		F: 2k (Annunicator) B: 8k (Link relay) V: 2k (Edge relay) SM: 2k (Special relay) SB: 2k (Special link relay)		
	Timers counters	T: 2k (Timer) St: 0k in default (retentive timer) C: 1k in default (counter) Size of fast/slow timers are assigned in the parameter Fast timers: Timer unit range 1 to 100ms, Slow timers: Time unit range 10 to 1000ms Up to 48 interrupt counters can be assigned among 1k total counters				
	Word devices	D: 12k (Data register) W: 8k (Link register) SD: 2k (Special register) SW: 2k (Special link register)				
File register		1,018k words				
Pointers (point)		P: 4k (Program pointer) I: 48 (Interrupt pointer)				
Index register (point)		16				
Devices for subroutine call with arguments		FX: 16 (Subroutine input) FY: 16 (Subroutine output) FD: 5 (Subroutine register)				
Type of value		16 bit integer, 32 bit integer, Single accuracy real, Character strings				
IC memory card	Capacity	Max. 2036k bytes×2 cards				
	No. of files	Max. 256				
Real time clock	Data	Year, Month, Date, Hour, Minute, Second, Day				
	Accuracy	-2.3 to +4.4 sec (typ+1.8 sec) @ 0°C -1.1 to +4.4 sec (typ+2.2 sec) @ 25°C -9.6 to +2.7 sec (typ+2.4 sec) @ 25°C				
5VDC consumption (A)		1.4	0.6	0.3		

A Series CPUs

■ Specifications of AnU, AnA and AnN CPUs

Item		A4UCPU	A3UCPU	A2UCPU-S1	A2UCPU
Control system		Repeated operation using stored program			
I/O control method		Refresh mode (direct mode can be used partially in accordance with the instruction)			
Programming language		Language dedicated to sequence control. Combined use of relay symbol type and logic symbol type.			
Number of instructions	Sequence instructions	25			
	Basic instructions	235			233
	Application instructions	204			
Processing speed (sequence instruction)		0.15 μsec/step		0.2μsec/step	
I/O points	Total incl. remote	8192			
	Local	4096	2048	1024	512
Watchdog timer (WDT)		200 msec			
Memory capacity		1024k byte		448k byte	
Compatible memory cassette		A3NMCA-0 to 56 A3AMCA-96 A4UMCA-128 A4UMCA-8E A4UMCA-32E A4UMCA-128E	A3NMCA-0 to 56 A3AMCA-96 A4UMCA-8E, 32E	A4UMCA-8E, 32E A3NMCA-0 to 56	
Program capacity	Main	30k step	30k step	14k step	
	Sub	30k stepx3	30k step	N/A	
Internal relay (M)		7144 points (M0 to 999, M2048 to 8191) (default value)			
Latch relay (L)		1048 points (L1000 to 2047) (default value)			
Link relay (B)		8192 points (B0 to 1FFF)			
Time (T)	Number of points	2048 points (default 256)			
	100 ms	T0 to T199 (0.1 to 3276.7 sec)			
	10 ms	T200 to T255 (0.01 to 327.67 sec)			
	100 ms retentive timer	None (default value) (0.1 to 3276.7 sec)			
	Extension timer	T256 to T2047			
Counter (C)	Number of points	1024 points (default 256)			
	Normal counter	C0 to C255 (range: 0 to 32767)			
	Interrupt counter	None (default value)			
	Extension counter	C256 to C1023			
Data register (D)		8192 points (D0 to D8191)			
Link register (W)		8192 points (W0 to W1FFF)			
Annunciator (F)		2048 points (F0 to F2047)			
File register (R)		Max. 8192 points (R0 to R8191)			
Accumulator (A)		2 points (A0, A1)			
Index register (V, Z)		14 points (V, V0 to V6, Z, Z1 to Z6)			
Pointer (P)		256 points (P0 to P255)			
Interrupt pointer (I)		32 points (I0 to I31)			
Special relay (M)		256 points (M9000 to M9255)			
Special register (D)		256 points (D9000 to D9255)			
Self diagnostic functions		Watchdog timer, memory error detection, CPU error detection, I/O error detection, battery error detection, etc.			
Operation mode at time of error		STOP / CONTINUE			
STOP to RUN mode		Output data at time of STOP restored/data output after operation execution			
Allowable momentary power failure		20 ms			
Current consumption (DC 5V)		0.5A	0.5A	0.4A	0.4A
Weight		0.6 kg / 1.3 lb	0.6 kg / 1.3 lb	0.5 kg / 1.1 lb	0.5 kg / 1.1 lb

A3ACPU (P21/R21)	A2ACPU-S1 (P21/R21)	A2ACPU (P21/R21)	A3NCPU (P21/R21)	A2NCPU-S1 (P21/R21)	A2NCPU (P21/R21)	A1NCPU (P21/R21)
Repeated operation using stored program						
Refresh mode (direct mode can be used partially in accordance with the instruction)			Refresh mode or direct mode (switchable)			
Language dedicated to sequence control. Combined use of relay symbol type and logic symbol type.						
25			26			
235	233		242	238		234
200			N/A			
0.15μsec/step	0.2μsec/step		1.0–2.3μsec/step in direct mode, 1.0μsec/step in refresh mode			
2048	1024	512	2048	1024	512	256
2048	1024	512	2048	1024	512	256
200 msec			10 to 2000 msec			
768k byte	448k byte		320k byte			16k byte
A3NMCA-0 to 96	A3NMCA-0 to 56		A3NMCA-0 to 40			
30k step	14k step		30k step	14k step		6k step
30k step	N/A		30k step	N/A		N/A
7144 points (M0 to 999, M2048 to 8191) (default value)			1000 points (M0 to 999) (default value)			
1048 points (L1000 to 2047) (default value)			1048 points (L1000 to 2047) (default value)			
4096 points (B0 to FFF)			1024 points (B0 to 3FF)			
2048 points (default 256)			256 points			
T0 to T199 (0.1 to 3276.7 sec)			T0 to T199 (0.1 to 3276.7 sec)			
T200 to T255 (0.01 to 327.67 sec)			T200 to T255 (0.01 to 327.67 sec)			
None (default value) (0.1 to 3276.7 sec)			None (default value) (0.1 to 3276.7 sec)			
T256 to T2047			N/A			
1024 points (default 256)			256 points			
C0 to C255 (range: 0 to 32767)			C0 to C255 (range: 0 to 32767)			
None (default value)			None (default value)			
C256 to C1023			N/A			
6144 points (D0 to D6143)			1024 points (D0 to D1023)			
4096 points (W0 to WFFF)			1024 points (W0 to W3FF)			
2048 points (F0 to F2047)			256 points (F0 to F255)			
Max. 8192 points (R0 to R8191)			Max. 4096 points (R0 to R4095)		N/A	
14 points (V, V0 to V6, Z, Z1 to Z6)			2 points (A0, A1)		2 points (V, Z)	
			256 points (P0 to P255)			
			32 points (I0 to I31)			
			256 points (M9000 to M9255)			
			256 points (D9000 to D9255)			
Watchdog timer, memory error detection, CPU error detection, I/O error detection, battery error detection, etc.						
STOP / CONTINUE						
Output data at time of STOP restored/data output after operation execution						
20 ms						
0.6A	0.4A	0.4A	0.9A	0.73A	0.73A	0.53A
0.7 kg / 1.5 lb	0.7 kg / 1.5 lb	0.7 kg / 1.5 lb	0.65 kg / 1.4 lb	0.62 kg / 1.4 lb	0.62 kg / 1.4 lb	1.45 kg / 3.2 lb

QnA CPU Features

■ High speed processing

The requirement for faster processing speed of PLC systems will never end because faster processing means shorter production time, more precise control, and better quality in applications. MSP (Mitsubishi Sequence Processor) performance has been greatly improved compared to the types used in AnA/AnUCPU. QnACPU gives roughly 3 times faster processing speed than AnUCPUs.

	Q4ARCPU Q4ACPU	Q3ACPU	Q2ACPU (S1)
LD X (input)	0.075μs	0.15μs	0.20μs
OUT T (timer)	0.60μs	1.20μs	1.60μs
MOV	0.225μs	0.45μs	0.60μs
+	0.90μs	1.80μs	2.40μs

Note: Processing time varies depending on accessing device type.

■ Large built-in memory and optional IC card

Each CPU module is equipped with a large built-in memory in addition to approximately 30k words of internal device memory. With the largest memory available, the Q4A and Q4ARCPU can control up to a 124k step program.

■ Global and local devices

MELSEC-QnA offers a new concept in internal device memory. In support of the multiple programming features of QnA PLCs, each program module can be installed with its own internal memory bank, called a 'local device.' The data of the local device does not influence the results of other program modules, and conversely it is not affected by other modules either. Local devices, then, can be used freely within program modules. At the same time, global devices with a common memory shared by all the program modules are also available, and can be used for interlocking of program modules.

■ Multiple programs

Up until now, PLC programs were generally composed of one long program which handled all tasks, but because of PLC's scanning operation and program size, programming and debugging was not easy. Even utilization of a previously made program for another control application was not easy to implement.

MELSEC QnA can handle and execute multiple program modules. At the program design stage, program modules can be created process by process, function by function (e.g. of a machine) or designer by designer for concurrent design. There are many advantages to this approach.

- Easier to understand because each program module can be made for specific functions and program modules are smaller than one long program.
- Program merging is not necessary after parallel design of program modules by multiple designers.
- Easier to make standardized program modules which can be used repeatedly for other similar projects.
- Saves time for program up/down loading at debugging stage because of smaller program size.



Q4A

Q3A

■ Q6MEM Series IC memory card

Q6MEM are PCMCIA compatible IC memory cards that can extend the data memory size of the CPU. There are a number of memory sizes and types that can be chosen based on application requirements. Up to 2MB per card is available in the following formats: SRAM memory only, SRAM+ EEPROM and Flash ROM+SRAM.

Although an IC memory card is optional, it is required if the following apply.

- Sampling trace, Program trace, or Status latch function is used
- More than 16 fault records are required
- Store device comment in CPU
- File registers are required
- Local device function is used
- Program-boot from IC card is required
- Max. size of program (depending on CPU type) is created

■ Macro command

A ladder program block used frequently in a given program can be registered as a macro command and then utilized in any other program any number of times with different input and output devices. Use of this feature eliminates retyping of the same form of ladder block and helps standardize programming.

Pre-registered macro command libraries are also available. The macro library software SW□IVD-MSPQ/MSDQ consists of the following macro commands:

The special function module library MSPQ comprises ladder program blocks necessary for MELSEC special function modules such as the RS232C interface module.

The standard ladder program library MSDQ comprises ladder blocks generally required for machine controls such as on-delay timers and emergency stop detection.

A CPU Features



A1N CPU



A2UCPU
A2ACPU
A2N CPU



A2UCPU-S1
A2ACPU-S1
A2N CPU-S1



A4UCPU
A3UCPU
A3ACPU
A3N CPU

■ Large memory/program capacity

The A Series enables choice of memory size by removable memory cassette construction so that users can find the most economical memory size. From the smallest 16k byte memory cassette, A3NMCA-2, to the largest 1M byte, A4UMCA-128, 9 different memory cassette sizes are available. In addition, three additional EPROM type memory cassettes are provided for AnU users. Those memory cassette have EEPROM memory as non-volatile program storage in addition to the same size of SRAM memory.

■ Large I/O control

With the highest specification model of AnN or AnA, up to 2048 I/O can be controlled. With AnU, a CPU can control 512/1024/2048/4096 I/O depending on the model. This number of I/O can be directly connected to the CPU rack, but all AnU CUP models have the capacity to control 8192 I/O. This is the total of the directly connected I/O plus I/O controlled through the remote I/O system of MELSECNET/10 or CC-Link.

■ Compatibility

Compatibility is maintained among the AnN, AnA and AnU CPUs. All I/O modules, power supply modules, mounting racks, special function modules are common to all these CPU models. Also, the sequence program is upwardly compatible from AnN to AnA to AnU. In addition, programs for A Series are also compatible with A2C and AnS compact PLC Series.

■ Complete self-diagnostic functions

- A watchdog timer (WDT) that can be set in 10 ms increments up to a maximum of 2 sec., this function monitors calculation congestion.
- CPU fault detection such as arithmetic circuit check and RAM memory check.
- Memory fault detection by command check and parameter check.
- Automatic measurement of scan.
- Comment display of detected fault (A3N only).

■ Extended networking functions

All A Series PLCs support industry standard network systems such as Ethernet, PROFIBUS, MODBUS, and Mitsubishi's MELSECNET systems.

In addition, a newly developed 10M bps network, MELSECNET/10, has been added to the supported network line up. All A Series CPU modules are compatible with the MELSECNET/10 network and can exist in the same network segment. The combination of MELSECNET/10 and AnU offers maximum functionality and performance with a floating master function, increased 8k bits + 8k words of cyclically refreshed network device memory, 4 network segments per PLC and so on, in addition to conventionally available cable redundancy and network diagnostic monitoring.

The new open field network, CC-Link, is also supported by all the A Series PLCs.

■ Advanced RAS and debugging functions

Seventy-six diagnostic items are available. An error history log provides a list of the last 16 errors. Included is the time of error generation and details of which error occurred. CHK instructions identify the presence of user specified patterns at the PLC's inputs lines to identify faults in external circuits. On-line sampling trace, status latch and device memory bus monitoring functions are also available. Each of these contributes to the AnA's highly advanced performance characteristics.

Q4ARCPU Redundancy

The Q4ARCPU system has been specially designed for process control applications that require redundancy of PLCs and extensive process control features. Using state-of-the-art QnA PLC technology as its base architecture, the Q4ARCPU has a number of added features.



Q4ARCPU system

■ Configurations

The most suitable basic configuration can be chosen from the three different configurations shown as follows. The dual system offers redundancy of power supply modules, CPU modules and network modules and includes extensive

process control features. The dual power supply system provides redundancy of power supply modules only with the extensive process control features. The single system offers the process control features, but not redundancy.

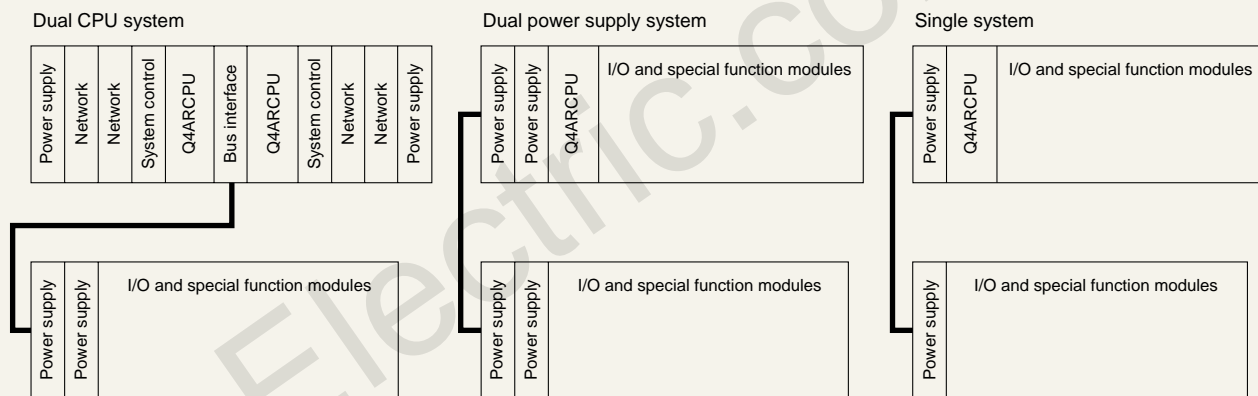

■ Math-coprocessor

The Q4ARCPU is equipped with a math-coprocessor in addition to the dedicated ladder processor MSP. The math-coprocessor allows the Q4AR to make floating point mathematical calculations 10 to 100 times faster than other CPUs.

Calculation	Q4ARCPU	Q4ACPU	A3ACPU
+	35μs	238μs	476μs
-	35μs	241μs	482μs
×	35μs	114μs	228μs
÷	38μs	373μs	746μs
SIN	34μs	2310μs	4620μs
COS	34μs	2460μs	4920μs
TAN	37μs	2485μs	4970μs

■ On-line module change

Main rack: Modules on the main rack including all CPUs except A6RAF and the rack itself can be replaced during on-line operations by turning the power supply for the fault module off.

Local & remote I/O rack: Digital I/O modules and power supply modules on a local I/O rack can be replaced when operation is on-line. Use of a programming tool to designate the I/O module to be replaced is necessary in order to avoid taking the wrong input signal or giving a wrong output signal.

Note: Special function modules on local I/O racks cannot be replaced.

Hot/Stand-by operation

The Q4ARCPU's dual CPU system provides hot/stand-by operations for PLCs. When the hot CPU is operating normally, all the I/O modules are controlled by the hot CPU. During that time, the stand-by CPU does not execute its program, but copies the internal device data of the hot CPU. If the operation of the hot CPU becomes abnormal, the stand-by CPU starts operations based on the most recent data it copied from the hot CPU and control of the system is resumed.

Data tracking

In order to resume operations either some or all of the internal device memory is copied to the stand-by CPU from the hot CPU, an operation called 'data tracking.' With data tracking, data of up to 48k words for a single scan and a greater amount for multiple scans is copied.

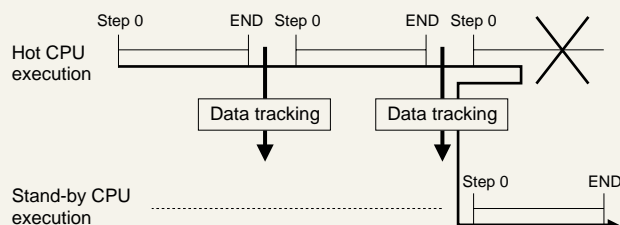

When switchover of the system occurs, the stand-by CPU resumes program execution based on the data from the most recent data tracking in order to ensure no data is lost. Because the reliability of tracked data is very important, the tracking circuitry has a parity check to ensure it. If any errors in the data are found, the stand-by CPU will reject the data and signal an alarm.

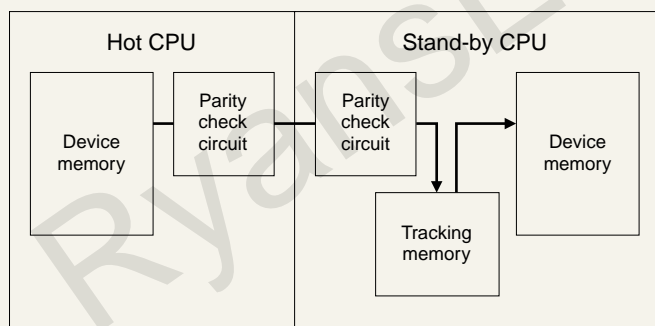

Note: Local devices cannot be assigned as tracking data.

Note: The data tracking area must be set by the user.

Program tracking

The programs in both CPUs have to be exactly the same, which means that when you first download a program it must be downloaded on both CPUs. Any revision, however, carried out to a program of the hot CPU during operation will be automatically copied to the stand-by CPU.

Note: Changes made to the stand-by CPU during operation will result in a stand-by CPU error, though the hot CPU will carry on in its operations despite it.

Control switchover

Control of the system will be switched over if any of the following errors is detected.

- AS92R detects any error related to the CPU, power supply, or to AS92R itself. (Refer to the items monitored by AS92R.)
- The network module is disconnected from MELSECNET/10 communications.
- The bus change request key switch located on A6RAF is activated.

If any of the above conditions, except for network module disconnection, is detected, the system will switch over within 300 msec. (The amount of time varies depending on the size of data tracking.) If a network disconnection is detected, system switchover will be complete within 3 sec.

Process control commands

In addition to the standard command set available in other QnACPU's, the Q4AR has 47 process control commands. The additional commands include various PID and PID related commands, compensation calculations, logical calculations, and comparisons. PID calculations are carried out with floating point values so the calculations are highly accurate.

These features make the Q4ARCPU compatible with process control applications.

Restrictions on modules for use with the Q4AR system

Prohibited from use:

With single Q4AR system	With dual Q4AR system
AJ71C23	Modules listed left
AD57-S2	AJ71AP21(-S3)
AJ71C24 (S/W Ver. G or earlier)	AJ71AP21GE, AJ71AR21
	AJ71P25, AJ72R25
AD51 (S/W Ver. G or earlier)	AJ71AT21B
A7GT-BUS (Ver. B or earlier)	AJ72T25B
AJ71LP21, AJ71BR11	AJ71QL21 (S), AJ71BR11
AJ72LP25, AJ72BR15	(S/W Ver. G or earlier)

Q4ARCPU Redundancy

Redundancy PC network system

Existing PCs and Redundancy PCs can be combined on the same network.

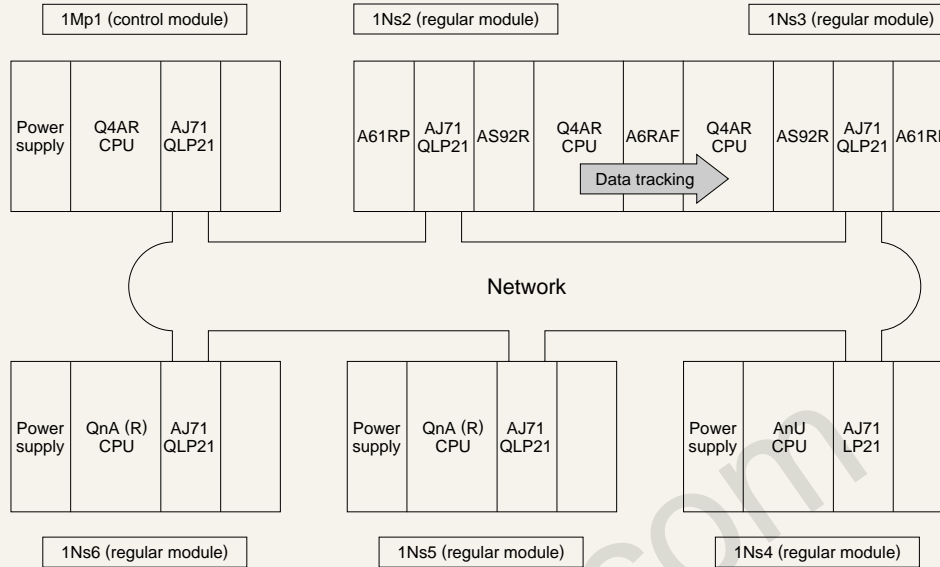

Compatible CPU modules

All of the QnA family of CPU modules from QnAS* to QnA to Q4AR can be used with this redundancy configuration. A smaller, low cost system can be configured for QnAS, and a larger system with QnA and Q4AR modules.

*The QnAS CPU is a compact sized CPU from the QnA series. Please refer to the QnAS/AnS CPU catalog for more details.

Each CPU, however, knows the status and controls the results of the other CPUs. A network device B/W can be used for data exchange between the CPUs. Up to 2k bytes of B/W can be sent from one CPU to the other every network scan.

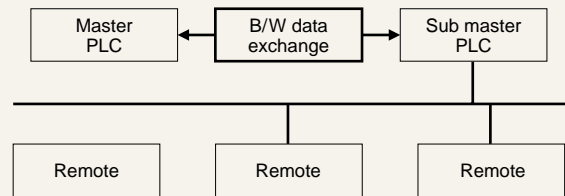

Operations

CPU: While the master CPU is normal and controlling remote I/Os, the sub-master CPU is executing its program and receiving remote I/O data via the network. Both CPUs carry out their respective programs, but they are not synchronized.

Master network module: Network modules of both the master and the sub-master are active, but the sub-master does not send data out to control remote I/Os when the master CPU is in normal mode.

Local I/O: Local I/O modules can also be used, but they cannot be controlled by the CPU module on the other side.

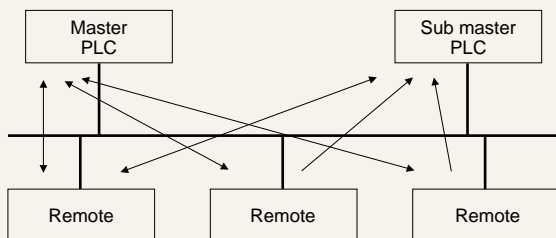

Exchange of data between CPUs

With this configuration each CPU runs its own programs. Whether the sub-master runs a program to resume control or not depends on the requirements of the application.

Control switchover

Control switchover occurs when any of the following is detected.

- The power supply of the master PLC has gone down
- The QnACPU on the master detects a fatal error that makes it impossible for the CPU to continue operations.
- The network module on the master is cut off from communications

Note: The direction of switchover is always from the master to the sub-master. Once control is switched over from the master to the sub-master, the sub-master does not switch back over to the master even if an error is detected. When the master, then, is ready to be put back online, it is recommended that both PLCs be reset as soon as possible.

Switchover time

Switchover time is as follows:

- In the case of a power, CPU, or network module failure, approximately 1 second is required to switch control.
- In the case of a network cable disconnection, approximately 3 seconds are necessary to switch control.

Item	Specification
Input voltage	100-120/200-240VAC +10/-15%
Input frequency	50/60Hz +/-5%
Max. input VA	110VA
Inrush current	20A within 8ms
Rated output	5VDC 8A
Over current protection	Over 8.8A
Over voltage protection	5.5 to 6.5VDC
Efficiency	65% or better
Power indication	LED
Terminal screw size	M4
Applicable wire size	0.75 to 2 sq-mm
Allowable power interruption	20ms or less
Withstand voltage	1500VAC 1min.
External signal	Power module abnormal signal (Normally closed relay) 240VAC/24VDC 2A

Features

- This control module monitors the power supply, the error status of the CPU, as well as its own error status. It sends error signals to the A6RAF and opens the corresponding relay output. It monitors the following:

CPU's self-diagnostic results
 CPU's operation
 AS92R's self-diagnostic
 5VDC power voltage
 24VDC power voltage
 Power supply failure signal

- Relays closed in normal conditions are provided to indicate errors to the external.
- 2 point inputs are provided for general use.

Features

- A6RAF switches the path accessible to the CPU to the local I/O rack.
- Bus switching is carried out when AS92R detects an error, or when the bus switching switch located on the A6RAF is triggered.
- A6RAF has a switch for selecting either Back-up mode or Separate mode.
- In the case both CPUs go down, there is a switch on A6RAF for selecting either Output hold mode or Reset mode.
- With A6RAF, it is possible to select which CPU will be the Hot CPU in the case where power to both CPUs is turned on at the same time.

■ A61RP Power supply module



■ AS92R System control module



■ A6RAF Bus Switching module

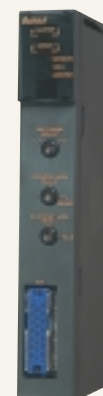

Product	Model	Note
Redundancy Main Base	A32RB	2 One Side I/O Slots
Redundancy Main Base	A33RB	3 One Side I/O Slots
Power Supply Extension Base for Redundancy	A68RB	8 I/O Slots
Power Supply Redundancy Base	A37RHB	7 I/O Slots

CPU Base Units and Cables

■ CPU base units

One CPU base unit is required for each AnU, AnA, AnN or QnA system. Each allows for one power supply module, one CPU module, and a maximum of either 2, 5 or 8 single slot size I/O modules. At either end of the base unit there is an expansion port for the connection of extension bases.

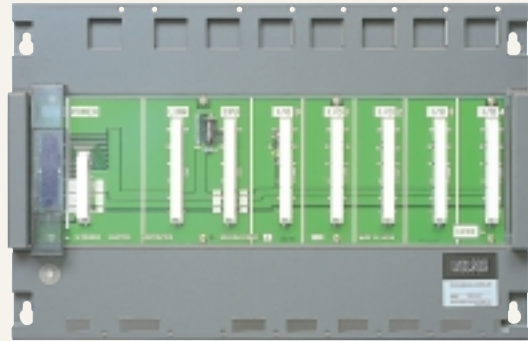

Item	A32B-E	A35B-E	A38B-E
Maximum number of I/O modules	2	5	8
Extension base connection	Not possible	Possible	Possible
Installation hole size	6mm (0.24 inch) dia. per shaped hole (for M5 screw)		
External dimensions mm (inch)	247 (9.72) x 250 (9.84) x 29 (1.14)	382 (15.04) x 250 (9.84) x 29 (1.14)	480 (18.9) x 250 (9.84) x 29 (1.14)

■ Extension base units

There are two different types of extension base units. One which allows for a power supply module; the other, which does not. Selection of which type should be used depends on the total 5 VDC current demand made on the power supply in the CPU base unit. If this total demand is lower than the output of the one power supply, then an additional power supply is not required and the more economical extension base unit can be used. There are two extension ports at either end of the unit and connection to other base units is made via extension cables.

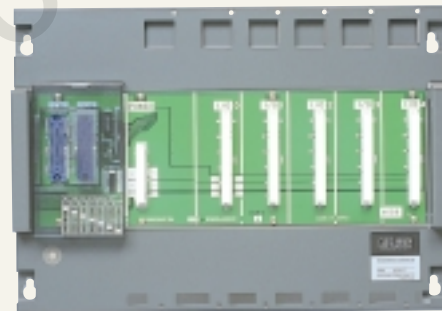

Item	A65B	A68B	A55B	A58B
Maximum number I/O modules	5	8	5	8
Power supply need	Power supply required		Power supply not required	
Installation hole size	6mm (0.24 inch) dia. per shaped hole (for M5 screw)			
External dimensions mm (inch)	352 (13.86) x 250 (9.84) x 29 (1.14)	466 (18.35) x 250 (9.84) x 29 (1.14)	297 (11.69) x 250 (9.84) x 29 (1.14)	411 (16.18) x 250 (9.84) x 29 (1.14)

■ Extension cables

These extension cables are used to connect two base units together. There are three different lengths of cable available: as shown below.



Item	AC06B	AC12B	AC30B
Cable length m (ft)	0.6m (1.97ft)	1.2m (3.94ft)	3m (9.84ft)

Power Supplies and Memory Modules

■ Power supply modules

Each A Series system requires at least one power supply module inserted into the CPU base. Additional power supplies are necessary if A65B or A68B extension base units are used in the system configuration. The power supply requires an external power source of either 100/120VAC or 200/240VAC for A61P, A62P, A61PEU, A62PEU & A65P, 24VDC for A63P.

■ LVD compliant modules

From the 1st January 1997 the Low Voltage Directive (LVD) became mandatory within the EU. This directive is mainly concerned with the safety of electrical equipment operating above specified voltage levels. A61PEU, A62PEU and A63P have been newly developed to comply with relevant European safety standards EN61010-1 and EN61131-2 (applicable safety clauses only).



Model number	Input voltage	Rated output
A61P	100 to 120 VAC or 200 to 240 VAC	5VDC, 8A
A61PEU		
A62P	100 to 120 VAC or 200 to 240 VAC	5 VDC, 5A & 24 VDC, 0.8A
A62PEU		
A63P	24 VDC	5 VDC, 8A
A65P	100 to 120 VAC or 200 to 240 VAC	5 VDC, 2A & 24 VDC, 1.5A

■ Memory modules & IC's

All AnU, AnA, AnN and QnA CPU's require the installation of a memory module or chip before they can be operational. The memory modules and IC's available for use are shown in the table below. Maximum memory and CPU modules to which they are applicable are indicated.

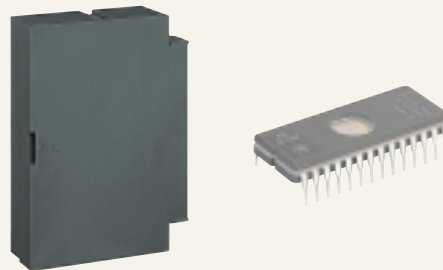

■ Memory modules

Item	A3NMCA-0	A3NMCA-2	A3NMCA-4	A3NMCA-8	A3NMCA-16	A3NMCA-24	A3NMCA-40	A3NMCA-56	A3NMCA-96	A4UMCA-128	A4UMCA-8E	A4UMCA-32E	A4UMCA-128E	
RAM memory capacity	None installed	16k	32k	64k	128k	192k	320k	448k	768k	1024k	64k	256k	1024k	
Number of ROM loading sockets	2 sockets for 28 pin ICs													
Loadable ROM type	4KROM, 8KROM, 16KROM													
Loadable RAM type	4KRAM	Unloadable												
Applicable CPU	A3A, A2A-S1, A2A, A3M, A3N, A2N-S1, A2N									A3A	A4U	A4U, A3U, A2U-S1, A2U		A4U

■ Memory IC's

Item	4KRAM	4KROM	8KROM	16KROM
Memory specifications	IC-RAM, read and write possible		EP-ROM, read only possible	
Memory capacity	8k byte	8k byte	16k byte	32k byte
Structure	28 pin IC package			
Remarks	When loading IC's into memory module or A1NCPUs, two identical type IC's are required.			

Input Modules

A complete range of input modules, suitable for all types of input devices.

There are over 16 different input modules available for use with the QnA and AnU, AnA, AnN Series, covering a wide range of voltages. From AC types to DC types, and even sensor input modules, you can choose the one which is correct for your application needs. They are available in 16, 32 or 64 point densities. All of them feature LED operation indicators and screen printed wiring diagrams on the front of the module. Modules fitted with terminal blocks can easily have them removed for ease of maintenance. Connector type models are simple to wire using standard type connectors.

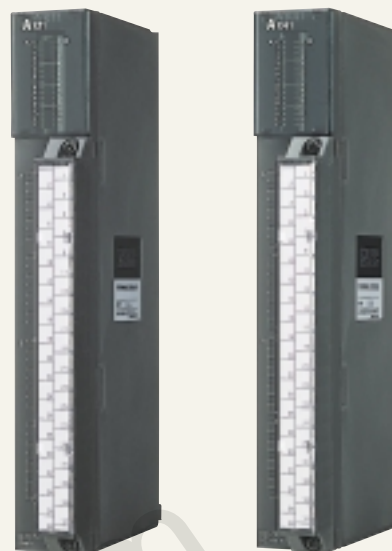

QnA and AnU, AnA, AnN input module specifications

Part number	Input type	Number of Input points	Insulation method	Input voltage	Input current	Response time		Trigger voltage/current		Indication	Connection type	Points/common	5 VDC current consumption		
						OFF-ON	ON-OFF	ON	OFF						
AX10	AC	16	Photo-coupler	AC 100-120	10mA	15 ms	25 ms	80V	40V	LED	Terminal block	16	55mA		
AX11		32										32	110mA		
AX11EU		150mA													
AX20		16		AC 200-240				160V	70V			16	55mA		
AX21		32						110mA							
AX21EU		150mA													
AX31		64		AC 24				7V	2.7V			110mA			
AX40	DC sink logic	16		DC 12/24	4/10mA	10 ms	10 ms	9.5V	6V		8	55mA			
AX41		32			110mA										
AX42		64			3/7mA						2 x FCN connector	32	120mA		
AX50-S1	DC sink or source logic	16		DC 48	4mA	10 ms	20 ms	34V	10V		Terminal block	8	55mA		
AX60-S1				DC 100/110/125	2mA			80V	20V				55mA		
AX70				DC 5/12/24	3.5/2/4.5 mA			1.5 ms	3 ms				3.5/5V selectable	1.2/2V selectable	55mA
AX71								32	55mA						
AX80	DC source logic	16		DC 12/24	4/10mA	10 ms	10 ms	9.5V	6V		55mA				
AX80E						5.5 ms	6 ms				55mA				
AX81-S1			10 ms			10 ms	5.6V			2.4V	110mA				
AX81-S2		32	DC 48/60	3/4mA	20 ms	20 ms	31V	10V	110mA						
AX82		64	DC 12/24	3/7mA	10 ms	10 ms	9.5V	6V	2 x 37 pin D type connector	32	120mA				

Output Modules

A full line up of output modules for all your automation needs

With over 30 types to choose from, the range of output modules available for use with the QnA and AnU, AnA, AnN Series cover nearly every automation output device you will ever use. There are four different types of output modules within the range, relay, triac/SSR, transistor, and TTL output types. Each come in 16 or 32 output point densities. The transistor output type is also available with 64 points/module. Detachable terminal blocks or connectors are used for making wiring connections and maintenance easier, and each module has LED's for output status indication.



■ QnA and AnU, AnA, AnN output module specifications

Part number	Output type	Number of Input points	Insulation method	Load voltage	Load current	Response time		Indication	Connection type	Points/ common	5 VDC current consumption								
						OFF-ON	ON-OFF												
AY10	Relay	16	Photo-coupler	AC 240 DC 24	2A	10ms	12ms	LED	Removable terminal block	8	150mA								
AY10A										1	150mA								
AY11										8	150mA								
AY11A										1	115mA								
AY11E		8								115mA									
AY13										230mA									
AY13E										230mA									
AY15EU	24	220mA																	
AY20EU	Triac/SSR	16		AC 100 - 240	0.6A	1ms	0.5cycle + 1ms			4	400mA								
AY22		2A			8					305mA									
AY23		0.6A			8					590mA									
AY40	Transistor, sink logic	16		DC 12/24	0.1	2ms	2ms			LED	Removable terminal block	1	190mA						
AY40A					0.3A							8	115mA						
AY40P		32			0.1A							16	230mA						
AY41												230mA							
AY41P		64			230mA														
AY42		16			0.5A							32	290mA						
AY50		Transistor, source logic			16							DC 12/24/48	2A	0.5ms	1.5ms	LED	Removable terminal block	8	115mA
AY51																		0.8A	16
AY51-S1					0.3A								8					310mA	
AY60					2A													115mA	
AY60E	2A/0.8A			8	115mA														
AY60EP	DC 12/24				115mA														
AY60S					DC 24/48	75mA													
AY70	Transistor, sink logic			32	DC 5/12	16mA	1ms			1ms	LED		Removable terminal block					16	200mA
AY71				64														32	300mA
AY72	Transistor, source logic			16	DC 12/24	0.5A	0.5ms			1.5ms	LED		Removable terminal block					8	115mA
AY80		0.8A										8		115mA					
AY80EP		32	0.5A	2ms		2ms		16	230mA										
AY81												0.8A		230mA					
AY81EP		64	0.1A	0.5ms		1.5ms		32	290mA										
AY82EP												2 x 37 pin D type connectors							

Analog Modules

■ A68AD/A68AD-S2 Analog input modules



■ Intelligent A/D conversion using built-in microprocessors

Analog input modules are available for all MELSEC QnA/A Series PLCs. Each is capable of accepting either current or voltage variable input signals. These signals are then converted in to a binary value by a built-in microprocessor, and can then be used for processing within the sequence

program. Input signals can be instantaneously read, or they can be sampled for user programmable time/count averaging processing. Setting offset and gain values for the converted values is also possible.

■ Analog input module specifications

Part number	A68AD (-S2)
Applicable QnA/A Series PLC	QnA/A Series
Number of output channels	8 channels
Analog output	Voltage: -10 to 0 to +10, input resistance 30k ohms Current: +4 to +20 mA, input resistance 250 ohms
Digital input	-2048 to +2047
Maximum resolution	Voltage: 5 mV (1/2000), Current: 20 μ A (1/1000)
Overall accuracy	$\pm 1\%$
Maximum conversion time	2.5 ms
Absolute maximum analog output	Voltage: ± 15 VDC Current: ± 30 mA
Insulation method	Photocoupler insulation between input terminals and internal circuitry No insulation between channels
I/O points required	32 points

Note: The A68AD-S2 type and log input module can be specially used to set a valid/invalid flag for the A/D transfer of each channel.

■ System configuration example

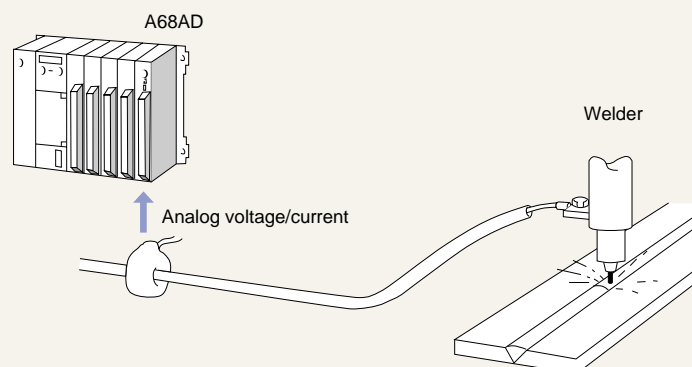

■ Analog output modules



■ Intelligent D/A conversion using built-in microprocessors

Analog output modules are available for all MELSEC QnA/A Series PLCs. Like the analog input modules each has a built-in microprocessor, which converts binary digital signals to

either current or voltage analog signals. Offset and gain values for the output signal can also be set and retained in the microprocessor.

■ Analog output modules specifications

Part number	A62DA
Applicable QnA/A Series PLC	QnA/A Series
Number of output channels	2 channels
Analog output	Voltage: -10 to 0 to +10, external load 500k - 1M ohms Current: +4 to +20 mA, external load, 0 - 600 ohms
Digital input	±2000 for voltage, ±1000 for current
Maximum resolution	Voltage: 5 mV (1/2000), Current: 20 µA (1/1000)
Overall accuracy	±1%
Maximum conversion time	16ms
Absolute maximum analog output	Voltage: ±12 VDC, Current: 28 mA
Insulation method	Photocoupler insulation between input terminals and internal circuitry No insulation between channels
External power supply	24VDC
I/O points required	32 points

■ System configuration example

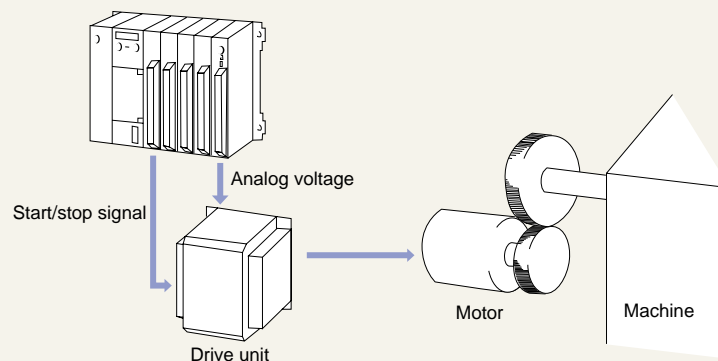

Analog Modules

■ A616 Series analog modules



■ High speed, high density analog modules for advanced applications

The A616 high density modules provide increased power and more flexible analog I/O capability. Both the analog input and output modules have sixteen channels per module; seven of which can be combined with multiplexer units. Utilizing these yields a maximum total of 121

channels per base module. The multiplexer units are available in three different types. One which provides isolated channels; another which gives non-isolated channels, and one which is for use with the thermocouple input module.

■ A616 analog module specifications

Part number	A616AD	A616DAV/A616DAI	A60MX/A60MXR/A60MXT
Applicable QnA/A Series PLC	QnA/A Series		
Number of I/O points required	32 points	32 points	16 points
Number of output channels	16 channels	16 channels	16 channels
Analog output/input	V input: -10 to 0 to +10 VDC. Input resistance 1M ohms I input: 4 to +20 mA, Input resistance 250 ohms	V output: -5/10 to 0 to +5/10 VDC I output: 0 to 20mA	As per base module connected to
Digital input/output	Output: -48 to 4047 or -2048 to +2047	Input: V -4096 to +4095, I 0 to 4095	As per base module connected to
Maximum resolution	1/4000	Voltage: 1.3/0.65 mV Current: 2.64 μ A	As per base module connected to
Overall accuracy	$\pm 0.3\%$	$\pm 0.5\%$	$\pm 0.2\%$
Maximum conversion time	1ms/channel	0.5ms/channel	As per base module connected to
Absolute maximum analog output/input	V input: ± 15 VDC I input: ± 30 mA	V input: ± 12 VDC I input: ± 28 mA	As per base module connected to
Insulation method	Photo coupler insulation between input terminals and internal circuitry No insulation between channels		A60MX - no insulation between channels A60MXR - insulation between channels
External power supply	Not required	-15, 0, +15 VDC (from A68P)	As per base module connected to

■ System configuration example

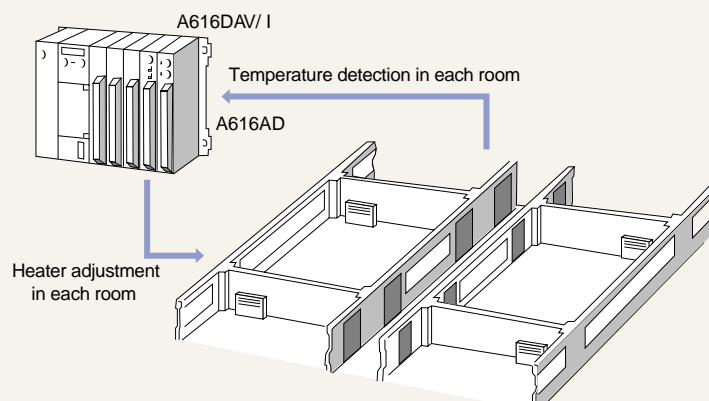

■ A616TD, A68RD3/4 Thermocouple input modules



The A616TD and A68RD3/4 thermocouple input modules allow the direct connection of thermocouple devices to the PLC. Each of the modules convert the inputted signal from the thermocouple device into a digital value representing the detected temperature value. This detected temperature value can then be utilized within the PLC sequence program.

The A616TD thermocouple input module has the additional function of accepting other temperature sensing devices which produce an analog input. Connection with a multiplexing unit A60MX/MXT/MXR is also possible; providing up to 960 sensor inputs.

■ A616TD, A68RD3/4 specifications

Part number	A616TD	A68RD3/4
Applicable QnA/A Series PLC	QnA/A Series	
Number of I/O points required	32	
Number of input channels	16	8
Temperature sensor input	-200 to 1800°C	-180 to 600°C
Digital output values	0 to 4000 digital -2000 to 18000 temperature val	-1800 to 6000 or -180000 to 600000
Acceptable thermocouples	JIS, ANSI, DIN, BS (see manual)	Pt100/JPt100 RD3 3-wire type RD4 4-wire type
Overall accuracy	±0.5°C or 0.6%	±1%
Cold junction compensation range	-20 to 80°C	Not available
Maximum conversion speed	50 ms/channel	40 ms/channel
Insulation	No insulation between channels	

■ System configuration example

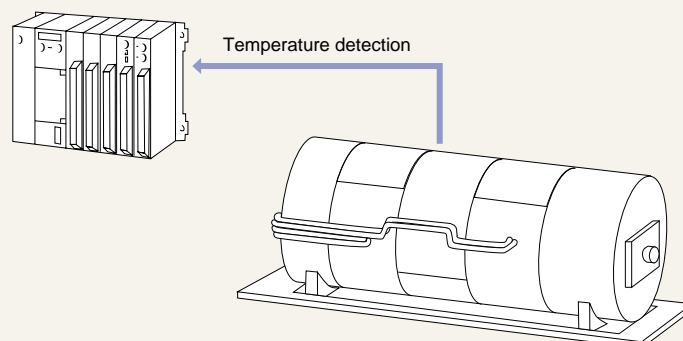

Positioning Modules

■ AD75P1-S3, AD75P2-S3, AD75P3-S3 AD75M1, AD75M2, AD75M3 Positioning modules

The AD75 Series of modules represents the combination of Mitsubishi's technological expertise in the manufacture and design of CNC, Inverter, Servo and PLC systems. These modules provide a plethora of functions which satisfy the requirements of even the most demanding of positioning applications.

■ Up to 3-axes operation

The module controls up to three axis operations yet occupies only one slot size making it economical for motion control applications. Types of modules provided are:

- 1 axis - AD75P1-S3, AD75M1
- 2 axes - AD75P2-S3, AD75M2
- 3 axes - AD75P3-S3, AD75M3

■ Increased positioning data memory

Number of positioning data per axis is increased to 600 from 400 of AD71. In addition, the data is stored in flash ROM so that no battery is required.

■ S-curve acceleration/deceleration

The S-curve acceleration/deceleration function enables smoother start and stop, and reduces stress on machines.

Up to 4 different acceleration and deceleration times can be defined, and used for each positioning operation.

■ Interpolation

Linear and circular interpolation can be operated with any combination of two axes.

■ Variety of original point return method

Six types of original point return methods are provided allowing greater flexibility of machine design and configuration. Automatic original point return function enables the machine to return to the original point from anywhere within the hardware stroke limit.

■ Positioning modules



■ Open-collector or differential driver

Either open-collector transistor or differential driver output can be selected to meet the motor amplifier's specifications. When using differential driver output, up to 400k pps can be transmitted as far as 30m (98.4 ft).

■ AD75TU, teaching unit

AD75TU, teaching unit is a handy programmer for AD75 Series modules. Monitoring of positioning status, JOG, teaching, test, and parameter and positioning data input can be carried out with this unit.

■ Extensive functions

AD75 has other very useful functions which include:

- Unit selection of mm, inch, degree, or pulse
- Electronic gear
- Step operation/ Skip operation
- Teaching
- Override speed
- Velocity control

■ AD75M, SSC net compatible controller

SSC Net is Mitsubishi's Servo System Control network. With this network, MR-H-B, MR-J-B and MR-J2 servo amplifier are connected to a controller through the network system instead of pulse train or voltage signals.

SSC Net system gives the following advantages:

- Up to 30m (98.4 ft) distance between an AD75M and an amplifier
- Amplifier parameter can be down-loaded from AD75M
- Amplifier's internal data can be monitored
- Possible to configure absolute systems

Specifications

Item	AD75P1-S3 AD75M1	AD75P2-S3 AD75M2	AD75P3-S3 AD75M3
Number of input/output points used	32 I/O		
Number of control axis	1-axis	Simultaneous 2-axis, Independent 2-axis	Simultaneous 3-axis, Independent 3-axis
Interpolating function	None	2-axis linear interpolation 2-axis circular interpolation (auxiliary and center point designation)	
Control method	PTP control, CP control (capable of setting for both linear and circular control), speed control, speed position control		
Control unit	mm, inch, degree, PULSE		
Program	Language	Table (AD71 method)	
	Positioning pattern	600 patterns/axis (However, 100 patterns can be used from ladder, and data is lost on power down). Indirect specification = No. 8001 to 8050, Home position return = No. 9001, High-speed home position return = No. 9002, Present value change = No. 9003	
	Setting device	IBM PC or compatible	
	Backup	Program is stored in a flash ROM (without battery)	
Positioning	Positioning method	PTP control ... Incremental method/absolute method selected Speed position control ... Incremental method Locus control ... Incremental method/absolute method selected	
	Position command range	Absolute method (address)	
		-214748364.8 to 214748364.7 (m), -21474.83648 to 21474.83647 (inch) 0 to 389.99999 (degree), -2147483648 to 2147483647 (PLS)	
		Incremental method (travel value)	
		Other than during speed-position changeover control	
		-214748364.8 to 214748364.7 (m), -21474.83648 to 21474.83647 (inch) -21474.83648 to 21474.83647 (degree), -2147483648 to 2147483647 (PLS)	
		During speed-position changeover control	
	Speed command range	0.01 to 6000000.00 (mm/min), 0.001 to 600000.000 (inch/min), 0.001 to 600000.000 (degree/min), 1 to 1000000 (PLS/sec)	
	Accel./ decel. operation	Automatic trapezoidal acceleration/deceleration, Automatic S-pattern acceleration/deceleration	
	Acceleration/ deceleration time	0-65535 (msec) for 16-bit setting. However, it shall be possible to change over between 16-bit and 32-bit using parameters, with 16-/32-bit changeover bit created (hidden function). For 32-bit setting, acceleration/deceleration time can be set in the range of 0 to 2147483647 (msec). Up to four patterns can be set for acceleration and deceleration, respectively.	
Sudden stop decel. time	1 to 65535 (ms)		
Start-up time	10 msec or less		
Compensation	Electronic gear	0 to 65535 Position command unit (unit magnification)	
	Backlash compensation	0 to 65535 Position command unit	
	Error compensation func.	With mechanical system error compensation function (with electronic gear)	
Home position return function	Near-zero point dog, Counting type×2, Stopper type×3		
JOG operation function	JOG operation by means of JOG start-up signal (each axis)		
Manual pulse generator operation function	Manual pulse generator operation possible (one manual pulse generator)		
M-code output function	M-code output function (WITH mode, AFTER mode selectable)		
Error indication	Available (Indicated by 17-segment LED display)		
Input/output indication	Available (Indicated by 17-segment LED display and LED lamp)		
Absolute position system	Available		
Internal current consumption	5 VDC, 1.0 A or less		

Positioning Modules

■ AD71 Positioning modules; pulse train output

The AD71 is a pulse train output type positioning module with linear interpolation. It is suitable for use with both pulse and servo motors.

High speed positioning is attainable over a wide positioning range. In addition the positioning control unit can be set in accordance with the application; i.e. pulse, mm. inch, and degrees. Compensation functions are also available for improving positioning accuracy.



■ AD71 specifications

Part number	AD71
Applicable QnA/A Series PLC	QnA/A Series
Number of control axes	2 (simultaneous or linear)
Interpolation	Linear interpolation (for 2 axes)
Positioning data capacity	400 points per axis
Positioning method	Absolute and/or incremental
Positioning range	1 to 16,252,928 pulse
Positioning speed	10 to 200,000 pls/sec
Acceleration and deceleration time	64 to 50,000 msec
Positioning compensation	Backlash and error compensation
Other functions	Zeroing and jog operation
I/O points required	32 points

■ System configuration example

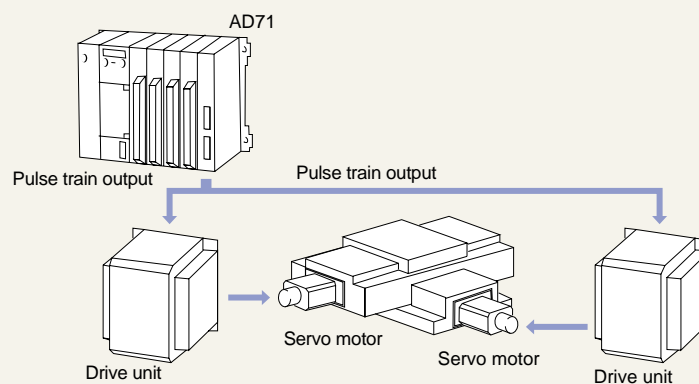

■ AD70, AD70D, AD72 Positioning modules

High speed positioning is attainable over a wide positioning range. In addition the positioning control unit can be set in accordance with the application; i.e. pulse, mm. inch, and degrees. Compensation functions are also available for improving positioning accuracy.

AD72 is a voltage output type positioning module. It can be used in conjunction with a servo motor for closed loop control precision positioning applications.

AD70 and AD70D are single axis positioning control modules which can be connected to the MR-SB servo amplifier.



■ AD70, AD70D, AD72 specifications

Part number	AD70	AD70D	AD72
Applicable QnA/A Series PLC	QnA/A Series		
Number of control axes	1	2 (simultaneous or linear)	1
Interpolation	—	Linear interpolation (for 2 axes)	—
Positioning data capacity	1	400 points per axis	1
Positioning method	Absolute and/or incremental		
Positioning range	-2.147, 483, 648 to 2.147, 483, 647	-2.147, 483, 648 to 2.147, 483, 647	1 to 16,252,928 pulse
Positioning speed	1 to 400,000pps pls/sec	1 to 1,000,000 pls/sec	10 to 200,000 pls/sec
Acceleration and deceleration time	2 to 9,999 msec	4 to 9,999 msec	64 to 50,000 msec
Positioning compensation	—	—	Backlash and error compensation
Analog output	0 to ±10VDC, 10mA	—	0 to ±10VDC, 10mA
Other functions	Zeroing and jog operation		
I/O points required	32 points	32 points	48 points

■ System configuration example

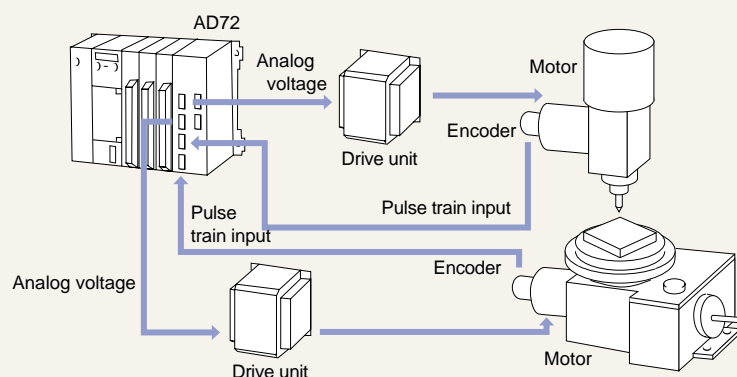

High Speed Counter Modules

■ AD61 (S1)

High speed counter module

The high speed counter modules are designed to accept input pulses at frequencies up to 50 kHz. Count input pulses with rise and fall times of as little as 500 μs can be counted. The modules have a wide counting range: from 0 to 16,777,215. The counter can be preset or disabled by external signals, as well as from the sequence program in the host PLC CPU.

Other features such as a ring counter function and external outputs are also available.



■ AD61 (S1) specifications

Part number	AD61 (S1)
Applicable OnA/A Series PLC	OnA/A Series
Number of input channels	2 channels
Count signal input	1 or 2 phase, 5/12/24 VDC, 2 to 5 mA
Maximum counting speed	AD61 50 kHz, AD61-S1 10 kHz
Count range	0 to 16, 777, 215
Count type	UP/DOWN preset counter and ring counter function
External input	12/24 VDC 3/6 mA, 5 VDC 5 mA
External output	Transistor (open collector) output 12.24VDC 5 mA
Current consumption	5 VDC consumption, 0.5A
I/O points required	32 points

■ System configuration example

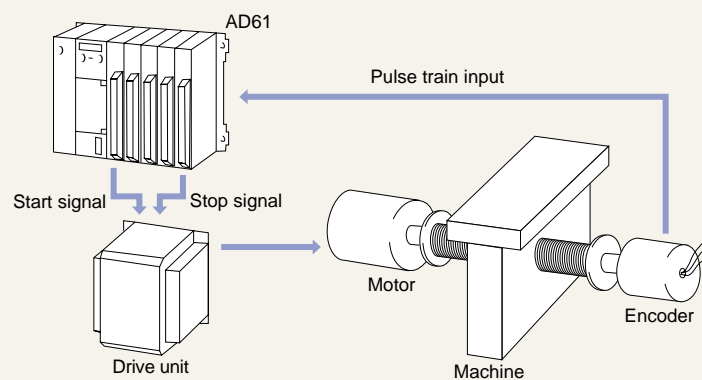

Ultrasonic Linear Scale Interface Module

■ A64BTL ultrasonic linear scale interface

A64BTL is an interface module for connecting an ultrasonic linear scale manufactured by Balluf. Use of this linear scale gives the following advantages:

- Sealed construction so that it can be located in fluid.
- No accuracy degrading by friction



■ A64BTL specifications

Item	Specifications	
Applicable QnA/A Series PLC	QnA/A Series	
Number of I/O points required	32	
Number of channels	4 channel	
Sensor interface	Range	0.000 to 3550.000 mm
	Resolution	0.025 mm
	Sampling period	2 ms
	Accuracy	Type: $\pm(\text{resolution}) \times 2$, Max: $+(\text{resolution}) \times 5 / -(\text{resolution}) \times 2$
Coincident output	Address range	24 bit
	Logic	DOG ON \leq present address < DOG OFF
	Number of outputs	(4 points \times 1 DOG) / channel
Applicable scale	BTLP, M type manufactured by Balluf	
5VDC consumption	1.05A	

Intelligent Communication Module

■ AD51H-S3, High speed intelligent (BASIC) communication module

The AD51H-S3 is a high speed intelligent communications module capable of supporting up to four communications ports, 2 × RS232C, 1 × RS422, and 1 × parallel. It has an internal memory of 384k bytes for the storage of programs written in BASIC. These programs can be transferred to the module either by using an A6GPP/PHP or by using a VT220 compatible terminal.

Up to 8 BASIC programs can be executed concurrently and independently of the normal sequence program. Real time clock function and host processor interrupts are standard features providing user flexibility in creating data communication and collection capabilities.



■ AD51H-S3 specifications

Part number	AD51H-S3
Applicable QnA Series PLC	QnA/A Series
Number of I/O points required	48
Program language	AD51H BASIC
Number of tasks	Maximum 8 tasks
Task start conditions	Power ON, interrupt from PLC CPU, real time interrupt
Internal memory	Maximum 384k
General purpose I/O	27 input points, 17 output points
Buffer memory	6k byte
Interface	Channel 1; RS422, D shell connector Channel 2 & 3; RS232C, D shell connector Channel 4; parallel
Arithmetic and logic unit (ALU)	Performs high speed processing of BASIC's intrinsic functions such as trigonometric, inverse trigonometric, logarithm, exponential, square root, absolute value etc.
Clock element	Year, month, day, hour, minute, second
Console	A6GPPE, A6PHPE, VT-220 terminal

■ System configuration example

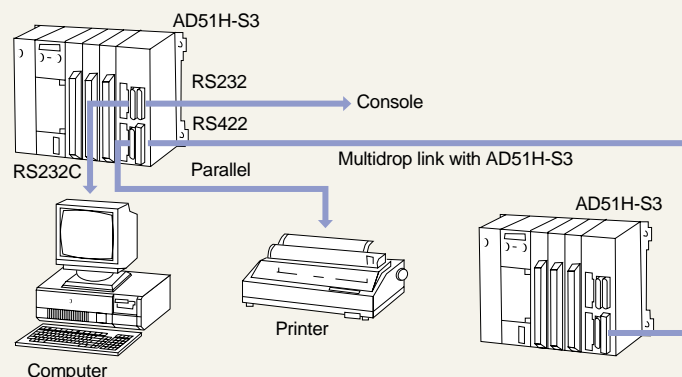

Parallel Interface Module

■ AD59

Parallel interface module

The AD59 parallel interface module allows the storing and printing out of large amounts of data. Data can be stored and accessed using the modules memory card interface, which allows a maximum of 32k bytes of data to be stored per memory card. This data can then be printed out via the modules built-in parallel interface.



■ AD59 specifications

Part number	AD59
Applicable QnA/A Series PLC	QnA/A Series
Number of I/O points required	32
Parallel interface	Number of channels: 1 Standards: Centronic FIFO memory capacity (1024 bytes) Insulation: Photocoupler Signal level: TTL level

■ System configuration example

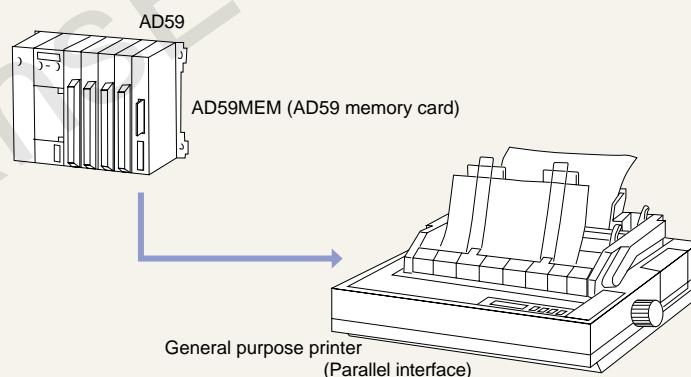

Interrupt Module

■ AI61, High speed interrupt input module

The AI61 is a high speed interrupt input module suitable for machine control applications which require rapid response times. When an interruption input signal is provided, the AI61 temporarily stops the normal sequence program from running and executes an interruption program according to the interruption vector.

The interruption start condition may be selected by the use of internal switches according to the type of equipment connected; i.e. interrupt may be started on the leading or trailing edge of the interrupt signal.



■ AI61 specifications

Part number	AI61
Applicable QnA/A Series PLC	QnA/A Series
Number of interruption inputs	16
Insulation method	Photocoupler
Rated input voltage	12/24 VDC
Rated input current	6/14 mA
Maximum simultaneous ON points	100% simultaneous ON
Input resistance	Approx. 24k ohms
Response time	OFF to ON & ON to OFF - 0.2 ms or shorter
Points per common	16
I/O points required	32 points

■ System configuration example

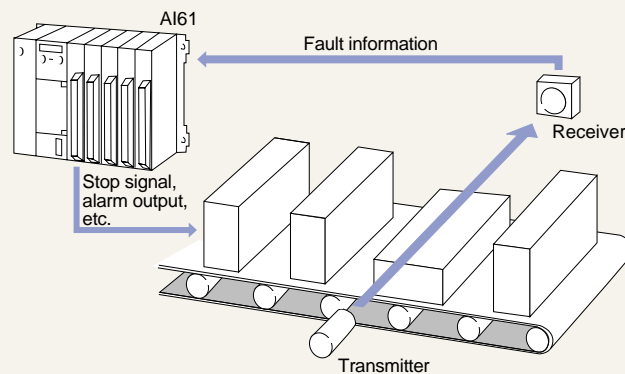

System Monitor Modules

■ AS91 system monitor module

The AS91 is a system monitor module which is loaded in an I/O slot of an QnA/A Series base unit. These modules monitor the I/O bus by inserting a fixed sequence program in front of the user program to monitor specific Y outputs. When using these modules, outputs are possible from an I/O bus error contact, a RUN contact and general purpose contacts. A 5 VDC check is also performed.

Further features include:

Self test function: This function serves to check that the module itself is functioning normally with the CPU in the STOP status.

Reset function: Allows an error output to be cleared (by pressing the reset push-button switch) when a bus fault occurs.



■ Specifications

Item	Specifications	
Applicable QnA/A Series PLC	QnA/A Series	
Output type	Contact output	
RUN output contact	1 point (ON in RUN status)	
Error output contact	1 point ("OFF" when normal / "ON" on error occurrence)	
General-purpose output contacts	3 points (switched "ON" and "OFF" by the program)	
Rated switching voltage/current	24 VDC, 2A (resistance load) 240 VDC 2A (COS θ =1) / 1 point	
Response time	OFF→ON	10 msec max.
	ON→OFF	12 msec max.
Life	Mechanical	Min. 20,000,000 operations
	Electrical	Rated switching voltage / current load: Min. 100,000 operations
		200 VAC, 1.5A / 240 VAC, 1A (COS θ =0.7): Min. 100,000 operations
		200 VAC, 0.75A / 240 VAC, 0.5A (COS θ =0.35): Min. 100,000 operations
24 VDC, 1A / 100 VDC, 0.1A (L/R=7 msec Min. 100,000 operations		
Maximum switching frequency	3600 times/hr	
Operation indicator	ON state indicated by LED	
External power supply	Voltage	24 VDC \pm 10%, ripple voltage less than 4 VP-P
	Current	30 mA

MELSECNET/10

MELSECNET/10 is a high speed network system offering higher performance than the MELSECNET II network system.

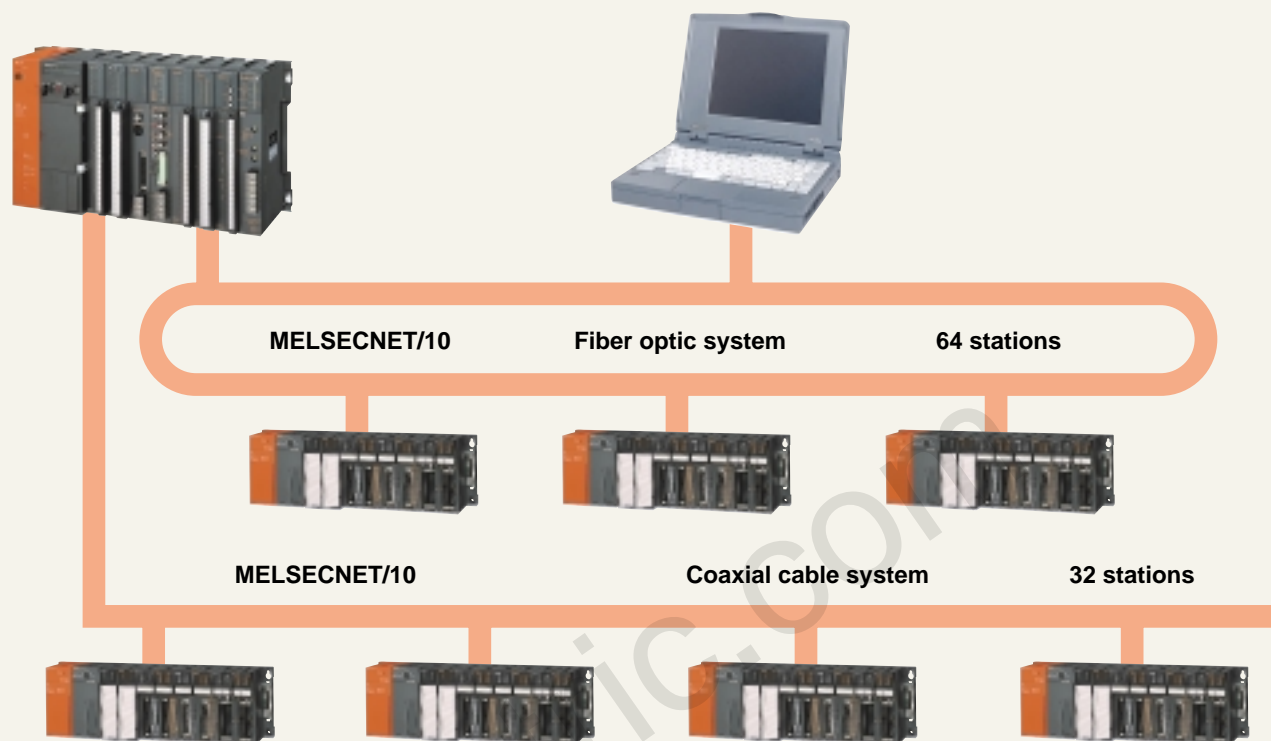

■ Up to 10/20M bps transmission speed

Computer supported flexible manufacturing requires more and more data flow on the factory floor. The high transmission rate can expand the number of transmission data while keeping through-put time from one PLC to another to a minimum. To achieve this aim, MELSECNET/10 has been developed to achieve 10M bps transmission rate, or 20M bps in dual transmission mode of dual loop system.

■ Fiber optic or coaxial cable

MELSECNET/10 offers fiber optic or coaxial cable networking. The fiber optic cable system has the advantage of no ambient noise and longer transmission distance. While the coaxial cable system has much lower cost of cabling.

■ High redundancy

Dual loop topology of the fiber optic cable system offers redundancy of cables. The system can continue to operate when a cable is accidentally disconnected or broken. In addition to cable redundancy, MELSECNET/10's token-pass communication method provides a floating master function. With this function, the network system can continue to operate using all connected PLCs, when a master PLC is shut-down.

■ Flexibility

Up to four MELSECNET/10 network modules can be installed in a single QnA or AnU PLC system with any mix of fiber optic or coaxial modules. Up to 255* network segments can be connected as one large network system and any data can be transmitted To/From any PLC in any network.

■ Extended network devices

The concept of network global devices, B & W devices, available in MELSECNET II is also incorporated in MELSECNET/10. The number of B & W devices has been extended to 8192 of each. (B0 to B1FFF & W0 to W1FFF). One handy feature of this concept is that no special programming knowledge of network communication is required.

■ PLC network or remote I/O network

MELSECNET/10 operates in either PLC-PLC network mode or remote I/O network mode. In PLC-PLC network mode, up to 64 PLCs in a dual loop system or up to 32 PLCs in a bus system can communicate with each other. In remote I/O network mode, up to 64 remote I/O stations in a dual loop system or up to 32 remote stations in a bus system can be controlled by one master PLC.

■ Diagnostic

Because network installation is often spread over a wide area, easy troubleshooting of the network is always an important factor when choosing a network type. Network monitor functions of the MELSECNET/10 system supply all the necessary information required for trouble shooting activities.

■ Compatibility of CPU

MELSECNET/10 allows any AnN, AnA, AnU or QnA to be connected to the system.

Note: A2ASCPU, A2U, A3U, A4U and QnACPU are fully compatible with MELSECNET/10. All other CPUs have limited compatibility.

MELSECNET/10 for QnA

Extended network devices

		QSI200/250 fiber optic loop system	GI50/125 fiber optic loop system	GI62.5/125 fiber optic loop system	Coaxial loop system	Coaxial bus system
For large QnA PLC	For PLC network & remote I/O master	AJ71QLP21 AJ71QLP21S	AJ71QLP21G	—	—	AJ71QBR11
For large A PLC	For PLC network & remote I/O master	AJ71LP21	AJ71LP21G	AJ71LP21GE	AJ71LR21	AJ71BR11
For large I/O	Remote I/O I/F	AJ72QLP25 AJ72LP25	AJ72QLP25G	A72LP25GE*	AJ72LR25*	AJ72QBR15

* QnA specific special function modules cannot be used on remote I/O rack with this remote I/O interface.

MELSECNET/10 specifications

Item	PLC network		Remote I/O network	
	Coaxial system	Fiber optic system	Coaxial system	Fiber optic system
Maximum network devices per network segment	LX/XY	8192 points		
	LB	8192 points		
	LW	8192 points		
Maximum network devices per station	$(LW \times 2) + (LB + LY) / 8 \leq 2000$ bytes		$M \leftarrow R: (LW \times 2) (LB + LX) / 8 \leq 1600$ bytes $M \rightarrow R: (LW \times 2) (LB + LY) / 8 \leq 1600$ bytes $M \leftrightarrow R: (LW \times 2) (LB + LY) / 8 \leq 2000$ bytes	
Allowable power interruption	20ms			
Transmission speed	10M bps (bus) 10/20M bps (loop)	10/20M bps	10M bps (bus) 10/20M bps (loop)	10/20M bps
Communication method	Token pass			
Synchronization	Frame synchronization			
Topology	Bus or dual loop	Dual loop	Bus or dual loop	Dual loop
Network distance	500/2500m (1640/8202 ft) (bus) 30km (98424 ft) (loop)	30km (98424 ft)	500/2500m (bus) (1640/8202 ft) (bus) 30km (98424 ft) (loop)	30km (98424 ft)
Distance between stations	500m (1640 ft)	500m (1640 ft) (SI 200/250) 1km (3280.8 ft) (QSI 200/250)	500m (1640 ft)	500m (1640 ft) (SI 200/250) 1km (3280.8 ft) (QSI 200/250)
Maximum number of network segments	255*			
Maximum number of groups	9			
Maximum number of stations	32 (bus) 64 (loop)	64	32 (bus) 64 (loop)	64
Modulation	Manchester	NRZI	Manchester	NRZI
Frame format	HDLC			
Frame check	CRC			

* 239 when any QnACPU is in the network system.

MELSECNET/II•B

MELSECNET II, MELSECNET/B

- A high speed, high reliability data link system

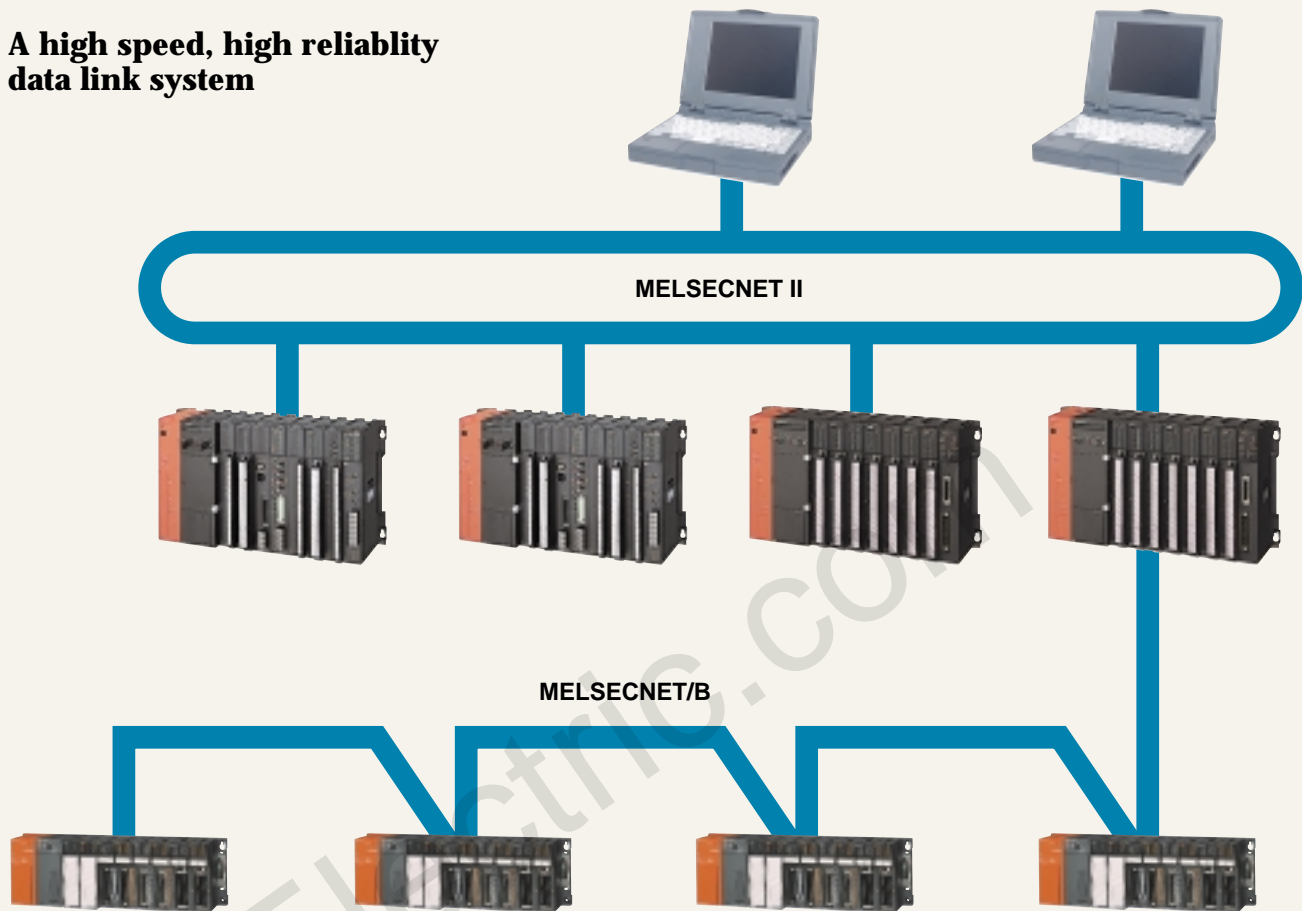

■ Choice of cable

The MELSECNET system offers a choice of four different varieties of cable. These range from the low cost twisted pair cable bus to dual coaxial cable to the highly reliable GI dual fiber optic cable network.

MELSECNET/B refers to the twisted pair cable bus system, while MELSECNET II to both coaxial and fiber optic systems. The software of both systems, however, provides the same range of functions.

■ Loopback function (MELSECNET II only)

The MELSECNET II data link system uses two parallel cable loops for connecting PLC stations, a forward (main) loop and a reverse (sub) loop. In the event of a break in the main loop, communications will be automatically switched to the sub loop maintaining the data link system. If there is a break in both loops, communications will continue among the remaining connected stations as shown.

■ Link up to 32 or 65 stations

In MELSECNET II system, one master and 64 slave stations can be connected per network. For MELSECNET/B, one master and 31 slave stations can be connected per network.

■ High speed transmission

A coaxial or fiber optic cable system is capable of transmitting data at 1.25M bps speed while the twisted pair cable system can transmit at 1M bps maximum.

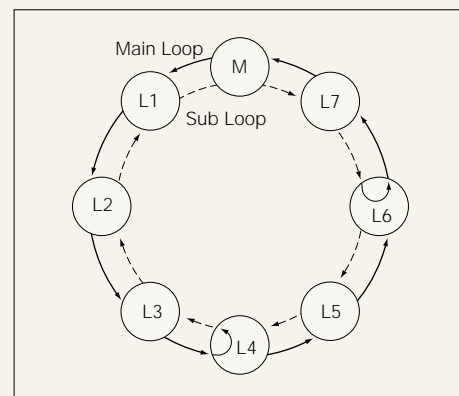

■ **AJ71AP21, AJ71AR21, AJ71AT21B MELSECNET interface module**

The MELSECNET interface module allows the host PLC CPU to be connected on to the MELSECNET data link system. The module allows the PLC CPU to act as a master or local station on the network, as defined by the switch setting on the module. There are two interface modules, one for fiber optic cable networks and the other for coaxial cable networks.

A maximum of one module can be used per PLC CPU.



■ **AJ71AP21, AJ71AR21, AJ71AT21B specifications**

	AJ71AP21	AJ71AP21-S3	AJ71AP21GE	AJ71AR21	AJ71AT21B
Communication speed	1.25M bps				1M - 125kbps
Communication method	Half duplex bit serial				
Synchronization method	Frame synchronization				
Topology	Dual loop				Bus
Distance (Overall)	10km (32808.4 ft)				0.1 - 1.25 km (328.1 - 4101 ft)
Distance (Between PLCs)	1 km (3280 ft)	2 km (6561.7 ft)	2 km (6561.7 ft)	500 m (1640.4 ft)	-
Number of connected stations	Max. 65 (1 master, 64 slaves)				Max. 32 (1 master, 31 slaves)
Modulation	CMI method				Manchester
Transmission format	Conforms to HDLC				
Error control system	Retry due to CRC time over				
Loop back function	Available				None
Cable type	QSI-200/250	GI-50/125	GI-62.5/125	Coaxial (75 ohm)	Twisted pair
Number of B/W	B:4096, W:4096 (MELSECNET II mode)				
Number of I/O points	32				
Current consumption (DC5V)	0.33A			0.8A	0.66A

■ **AJ72T25B MELSECNET/B remote I/O interface**

The module allows decentralized I/O control via the MELSECNET/B network. It can control up to 512 I/O points under a master PLC CPU.

■ **AJ72T25B specifications**

Connector type	Terminal block
Cable required	Shielded twisted pair
Interface standard	RS485
Maximum number of I/O points	512
Current consumption (5VDC)	0.3A

CC-Link

- **Easy connection of bit level devices combined with advanced message and data transmission is now a reality with CC-Link, a field network system giving more sophisticated field information control while reducing cabling costs.**

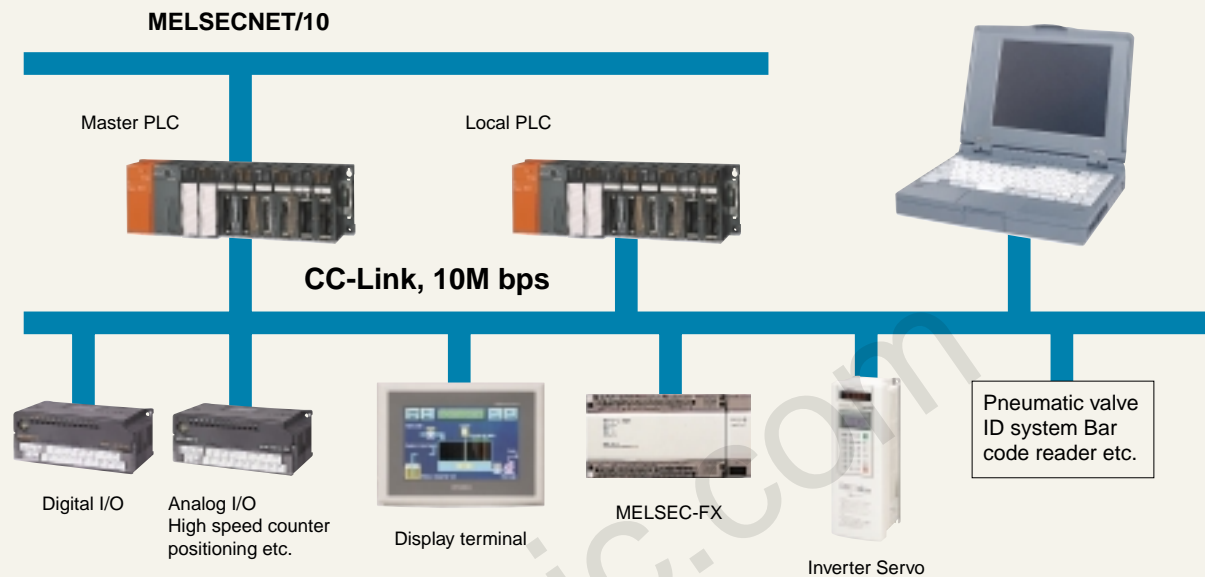

■ Control & information

For CC-Link system, three types of remote devices are connected as follows:

Remote I/O: Field devices which only require ON/OFF control for their function such as digital I/O or pneumatic valves are specified as this type. Only bit data can be communicated with this device type.

Remote Device: Field devices which handle register values (numeric data) such as analog I/O and counters are specified as this type. In addition to bit data, register data can also be communicated.

Intelligent Remote: This is a device which is allowed to access the master and/or other stations actively for data acquisition and control. Local PLCs, GOTs and programming interface units are specified as this type.

■ 10M bps high speed data transmission

CC-Link was developed not only for fast remote I/O control, but also for fast field information control. For this purpose, the transmission speed of CC-Link has been increased to 10Mbps compared to our previous field network system. This high speed performance allows communication of large volumes of data without affecting machine control speed.

■ Personal computer connection

The A80BDE-J61BT13 computer board (PCI bus) operates as a local station within CC-Link. This PC board allows both monitoring and testing of CC-Link from a personal computer. Users can develop their own monitor or test software in Visual Basic Ver. 5.0 or Visual C++ Ver. 5.0.

■ Master/local configuration

Unlike other field networks, CC-Link can configure master-local configuration in addition to master-remote configuration. A local PLC can communicate with the master PLC and other remote stations.

■ Multi-vendor connection

Many sensor and actuator vendors have joined the CC-Link partner program for direct connection of their devices with the network. Examples of devices are pneumatic valve, ID controller, bar code reader, robotics, display terminal, temperature controller and measurement sensors.

■ Hot/stand-by master configuration

A local PLC in CC-Link system can act as a stand-by master PLC for master PLC redundancy. Because of the increasing importance of filing data, such data should not be lost if the master shuts down. This function for CC-Link system gives a simple and inexpensive solution for redundant systems.

■ On-line I/O replacement

2-piece terminal block construction of remote I/O allows on-line I/O replacement without affecting other remote I/O control.

■ Specifications: Network

Item	Specifications
Transmission speed	156k/625k/2.5M/5M/10M bps
Maximum distance	1200m (limited to 156kbps)
Maximum number of connected stations	64 stations, however the following conditions apply: $\{(1 \times a) + (2 \times b) + (3 \times c) + (4 \times d)\} \leq 64$ a: number of 1 station modules b: number of 2 station modules c: number of 3 station modules d: number of 4 station modules $\{(16 \times A) + (54 \times B) + (88 \times C)\} \leq 2304$ A: number of remote I/O station modules ≤ 64 B: number of remote device stations ≤ 42 C: number of local, stand-by master and intelligent device stations ≤ 26
Maximum network data per network system	Remote I/O (RX, RY): 2048 points Remote register (RWw): 256 points (master to local/remote) Remote register (RWr): 256 points (local/remote to master)
Maximum network data per local/remote station	Remote I/O (RX, RY): 32 points (30 points for local) Remote register (RWw): 4 points (master to local/remote) Remote register (RWr): 4 points (local/remote to master)
Communication method	Polling
Synchronization method	Frame synchronization
Modulation	NRZI
Transmission path	Bus (RS485)
Frame format	HDLC
Frame check sequence	CRC
Applicable cable	Shielded twisted pair cable
RAS function	Automatic communication return function Slave station cut-off Error detection by special link relays/registers
Number of parameter registration	10,000 times
Occupied I/O points	32 points
5VDC consumption	A1SJ61BT11: 0.4A

■ Specifications: Communication speed & distance

Communication speed	Minimum distance between stations		Overall distance	
	Standard CC-Link ver.1.00	Standard CC-Link ver.1.10	Standard CC-Link ver.1.00	Standard CC-Link ver.1.10
156k bps	30cm (11.8 inch) or longer	20cm (7.9 inch)	1200m (3,937 ft)	1200m (3,937 ft)
625k bps			600m (1,969 ft)	900m (2,953 ft)
2.5M bps			200m (656 ft)	400m (1,312 ft)
5M bps	60cm (23.62 inch) or longer 30cm (11.8 inch) to 59cm (23.23 inch)		150m (492 ft)	160m (525 ft)
			110m (361 ft)	
10M bps	1m (3.28 ft) or longer 60cm (23.62 inch) to 99cm (38.98 inch) 30cm (11.8 inch) to 59cm (23.23 inch)		100m (328 ft) 80m (262 ft) 50m (164 ft)	100m (328 ft)

Note: All the CC-Link modules are now compatible with CC-Link ver. 1.10 step by step. Modules compatible with CC-Link ver. 1.10 have on their side a "CC-Link" seal.

Digital I/O Modules

- Input, output or input/output combined modules
- 16 pt terminal block, or 32 point high density connector
- 2-piece terminal construction for on-line I/O replacement
- 1 common per 2 I/O points type available



Small Sized Digital I/O Modules

- DIN Rail mountable
- Can be horizontally or vertically mounted
- Space saving small size
- One touch connector reduces wiring work



■ Specifications: Remote digital I/O

Input	Model	Type	Point	Insulation	Rated voltage	Rated current	Operation voltage (V)		Response time (ms)		Connection type	Point per common	Number of stations
							ON	OFF	ON	OFF			
							AJ65BTB1-16D	DC input Sink/source	16	Photocoupler			
AJ65BTB2-16D	16	16 (2-wire)											
AJ65BTC1-32D	32	Connector	32										

Output	Model	Type	Point	Insulation	Rated voltage	Rated current	Response time (ms)		Connection type	Point per common	Number of stations
							ON	OFF			
							AJ65BTB1-16T	Tr. Output Sink			
AJ65BTB2-16T	16	16 (2-wire)									
AJ65BTC1-32T	32	Connector	32								
AJ65BTB2-16R	Relay output	16	Relay	240VAC	2A/pt, 8A/com	10	12	Screw terminal	32		

Input / Output	Model	Input specifications										Point per common
		Type	Point	Insulation	Rated voltage	Rated current	Operation voltage (V)		Response time (ms)			
							ON	OFF	ON	OFF		
	AJ65BTB1-16DT	DC input Sink/source	8	Photocoupler	24VDC	7mA	14	6	10	10	16 (1-wire)	
	AJ65BTB2-16DT		8								16 (2-wire)	
	AJ65BTB2-16DR		8									
	Model	Output specifications							Common			
		Type	Point	Insulation	Rated voltage	Rated current	Response time (ms)		Connection type	Connection type	Number of stations	
							ON	OFF				
	AJ65BTB1-16DT	Tr. Output Sink	8	Photocoupler	24VDC	0.5A/pt, 4A/com	2	2	16 (1-wire)	Screw terminal block	1	
	AJ65BTB2-16DT		8									16 (2-wire)
	AJ65BTB2-16DR	Relay	8						240VAC			2A/pt, 8A/com

■ Specifications: Small sized remote digital I/O

	Model	Type	Point	Input current	Operation voltage (V)		Input response time		Connection type	Points per common	Number of stations
					ON	OFF	ON	OFF			
Input Modules	AJ65SBTC1-32D	DC sink/ source	32	Approx. 5mA	14	3	6	1.5ms	One touch	32	1
	AJ65SBTB3-8D		8							8	
	AJ65SBTB3-16D		16							16	
	AJ65SBTB1-8D		8							8	
	AJ65SBTB1-16D		16	Approx. 5mA	15	3	0.2ms	1.5ms	Terminal block	16	
	AJ65SBTB1-16D1									8	
	AJ65SBTB1-32D		32	Approx. 7mA	14	6	1.5ms	0.2ms	One touch	32	
	AJ65SBTB1-32D1									8	
	AJ65SBTC1-32D1		16	Approx. 5mA	14	6	1.5ms	1.5ms	Plug	16	
	AJ65SBTC4-16D									8	
	AJ65SBTW4-16D		AC	Approx. 7mA	80	30	20ms	Terminal block	8		
	AJ65SBTB2-8A								16		
AJ65SBTB2-16A	8										
AJ65SBTB2-8A	16										

	Model	Type	Point	Rated current		Output response time		Connection type	Points per common	Number of stations			
				1 point	Per common	OFF	ON						
Output Modules	AJ65SBTB1-16T1	Tr. Output sink	16	0.5A	3.6A	0.5ms	1.5ms	Terminal block	16	1			
	AJ65SBTB1-32T1		32						4.8A		32		
	AJ65SBTCF1-32T		8	0.1A	3.2A			FCN connector	8				
	AJ65SBTB2-8T		16	0.5A	3.6A			Terminal block	16				
	AJ65SBTB2-16T		8	0.1A	0.8A				8				
	AJ65SBTB1-8TE		16	1.6A	16								
	AJ65SBTB1-16TE		8	2.4A	8								
	AJ65SBTB1-8T		16	3.6A	16								
	AJ65SBTB1-16T		32	4.8A	32								
	AJ65SBTB1-32T		0.1A	3.2A	One touch			8					
	AJ65SBTC1-32T		Relay	8	2A			8A	10ms		12ms	Terminal block	16
	AJ65SBTB2-8R			16									8A
	AJ65SBTB2-16R	8		4A		8							
	AJ65SBTB2N-8R	16		8A		16							
	AJ65SBTB2N-16R	8		2.4A		8							
	AJ65SBTB2-8S	16		4.8A		16							
	AJ65SBTB2-16S	Triac Output	8	0.6A	2.4A	1ms	1/2 cycle+1ms	Terminal block	8				
	AJ65SBTB2-8S		16						4.8A		16		
AJ65SBTB2-16S	8		2.4A						8				
AJ65SBTB2N-8S	16		4.8A						16				

	Model	Type	Point	Input current	Operation voltage (V)		Input response time		Connection type	Points per common	Number of stations
					ON	OFF	ON	OFF			
Input/Output Modules	AJ65SBTC1-32DT	DC sink	16	Approx. 5mA	14	3	1.5ms		One touch	32	1
	AJ65SBTC1-32DT1				15	6	0.2ms				
	AJ65SBTC4-16DT				14	6	1.5ms		Plug		
	AJ65SBTW4-16DT	8	15	3	0.2ms		Waterproof plug	16			
	AJ65SBTC1-32DT	DC sink/ source	16	Approx. 7mA	14	6	1.5ms		One touch	8	
	AJ65SBTB32-8DT		8				Terminal block	16			
	AJ65SBTB32-16DT		16				Terminal block	16			

	Model	Type	Point	Rated current		Input response time		Connection type	Points per common	Number of stations
				1 point	Per common	ON	OFF			
Input/Output Modules	AJ65SBTC1-32DT	Tr. Output sink	16	0.1A	1.6A	0.5ms	1.5ms	One touch	32	1
	AJ65SBTC1-32DT1									
	AJ65SBTC4-16DT		32	0.1A	1.6A			One touch	8	
	AJ65SBTW4-16DT		8	0.5A	1.2A			Terminal block	16	
	AJ65SBTC1-32DT		16	2.4A	Terminal block			16		

AJ65BT-64AD, AJ65BT-64DAV AJ65BT-64DAI Analog I/O Modules

- 12 bit resolution
- A/D conversion or D/A conversion modules
- 4 channel per module



AJ65BT-68TD, AJ65BT-64RD3 AJ65BT-64RD4 Thermocouple and RTD Modules

- Isolation between channels (TD only)
- Wire breakage detection
- 8 channel per module (TD only)
- 4 channel per module (RD only)



■ Specifications: Remote analog input, remote analog output

Model	AJ65BT-64AD	AJ65BT-64DAV	AJ65BT-64DAI
Type	Analog input (V/I)	Analog output (Voltage)	Analog output (Current)
Number of channels	4 channel	4 channel	4 channel
Input impedance/ Output load impedance	Voltage input: 1MΩ, Current input: 250Ω	2kΩ to 1MΩ	0Ω to 600Ω
Analog range	-10 to 10V/-20 to 20mA 0 to 10V/0 to 20mA 0 to 5V/0 to 20mA 1 to 5V/4 to 20mA	-10 to 10V	4 to 20mA
Digital value	0 to 4000/-2000 to 2000	-2000 to 2000	0 to 4000
Maximum resolution	1/4000 (12 bit)		
Accuracy	+/-1%		
Conversion speed	1ms/channel		
Insulation	Between input circuit and internal circuit: Photocoupler insulation Between input circuits: No insulation		
Remote I/O type	Remote device		
Occupied station numbers	2 (RX/RX: 32 point each, RWr/RWw: 8 point each)		
Power supply	24VDC/0.12A	24VDC/0.18A	24VDC/0.27A

■ Specifications: RTD input, thermocouple input

Model	AJ65BT-68TD	AJ65BT-64RD3	AJ65BT-64RD4
Type	Thermocouple input	RTD input	
Number of channels	8	4	
Applicable sensors	B, R, S, K, E, J, T	Pt100 3-wire	Pt100 4-wire
Temperature range	-200 to 1700°C (Depending on sensor type)	-180 to 600°C	
Maximum resolution	B,R,S: 0.3°C, K,E,J,T: 0.1°C	0.025°C	
Accuracy	0.25%/0.5°C to 2.5°C @Ta=25°C (Depending on sensor type)	Max. 0.25%	
Sampling time	50ms/channel	40ms/channel	
Insulation	Transformer insulation between input circuit and internal circuit and between input channels	Photocoupler insulation between input circuit and internal circuit; no insulation between input channels	
Remote I/O type	Remote device		
Occupied station numbers	4 (RX/RX: 128 point each, RWr/RWw: 16 point each)		
Power supply	24VDC/0.08A	24VDC/0.17A	

AJ65SBT-64AD Analog to Digital Conversion Module

- Four analog input (voltage input/current input) channels are provided.
- Greater accuracy and higher resolution than the AJ65BT-64AD has been realized.
- Separate analog input ranges can be set for each channel.
- By incorporating a movement averaging process, the averaging process can be carried out without changing the conversion speed.
- The installation area is 60% smaller and the volume is 38% smaller than the AJ65BT-64AD.



AJ65SBT-62DA Digital to Analog Conversion Module

- Two analog output (voltage output/current output) channels are provided.
- Greater accuracy and higher resolution than the AJ65BT-64DAV/DAI has been realized.
- Separate analog output ranges can be set for each channel.
- The installation area is 60% smaller and the volume is 38% smaller than the AJ65BT-64DAV/DAI.

■ Specifications: Analog to digital conversion

Model	AJ65SBT-64AD						
	Voltage input				Current input		
Digital output	-10 to 10VDC (input resistance 1MΩ)				0 to 20mADC (input resistance 250Ω)		
Analog input	-4096 to 4095						
Input/Output characteristics	Analog input			Digital output	Analog input		Digital output
	-10 to 10V	0 to 5V	1 to 5V	—	0 to 20mA	4 to 20mA	—
	-10V	—	—	-4000	—	—	—
	0V	0V	1V	0	0mA	4mA	0
	5V	2.5V	3V	2000	10mA	12mA	2000
	10V	5V	5V	4000	20mA	20mA	4000
Maximum resolution	2.5mV	1.25mV	1mV	—	5μA	4μA	—
Accuracy	Within ±0.2% (25±5°C), Within ±0.4% (0 to 55°C)						
Conversion speed	1ms/channel						
Number of analog input points	4 channels/module						
Offset/gain adjustment	Provided (user setting or factory setting)						
Number of occupied input/output points (station type)	1 station: RX / RY 32 points each RWr/RWw 4 points each (remote device station)						

■ Specifications: Digital to analog conversion

Model	AJ65SBT-62DA						
	Voltage input				Current Input		
Digital Output	-4096 to 4095				0 to 4095		
Analog input	-10 to 10VDC (External load resistance: 2kΩ to 1MΩ)				0 to 20mADC (External load resistance: 0 to 600MΩ)		
Input/Output characteristics	Digital output	Analog input			Digital output	Analog input	
	—	-10 to 10V	0 to 5V	1 to 5V	—	0 to 20mA	4 to 20mA
	-4000	-10V	—	—	—	—	—
	0	0V	0V	1V	0	0mA	4mA
	2000	5V	2.5V	3V	2000	10mA	12mA
	4000	10V	5V	5V	4000	20mA	20mA
Maximum resolution	—	2.5mV	0.625mV	0.5mV	—	5μA	4μA
Accuracy	Within ±0.2% (25±5°C), Within ±0.4% (0 to 55°C)						
Conversion speed	1ms/channel						
Output short-circuit protection	Provided						
Number of analog input points	2 channels/module						
Offset/gain adjustment	Provided (user setting or factory setting)						
Number of occupied input/output points (station type)	1 station: RX / RY 32 points each RWr/RWw 4 points each (remote device station)						

AJ65BT-D62, AJ65BT-D62D AJ65BT-D62D-S1 Remote High Speed Counter

- Up to 400kpps counting (differential type)
- Two coincident outputs per channel
- Four special counting functions
Ring counter, latch counter, periodic pulse counter, count disable



AJ65BT-D75P2-S2 Remote Positioning Module

- 2 axes positioning control with linear or circular interpolation
- Pulse train output for either stepper or servo amplifier
- 32 bit positioning range
- Up to 1Mpps positioning speed (differential output type)
- Electronic gear function



■ Specifications: Remote high speed counter

Model	AJ65BT-D62		AJ65BT-D62D		AJ65BT-D62D-S1	
	High speed	Low speed	High speed	Low speed	High speed	Low speed
Counter mode	High speed	Low speed	High speed	Low speed	High speed	Low speed
Number of channels	2		2		2	
Input phase	Single phase or dual phase					
Maximum speed	1φ: 200kpps 2φ: 200kpps	1φ: 10kpps 2φ: 7kpps	High speed mode: 1φ: 400kpps, 2φ: 300kpps Low speed mode: 1φ: 10kpps, 2φ: 7kpps			
Minimum pulse width	1φ: 2.5/2.5μs 2φ: 2.5/2.5μs	1φ: 50/50μs 2φ: 71/71μs	High speed mode: 1φ: 1.25/1.25μs, 2φ: 1.65/1.65μs Low speed mode: 1φ: 50/50μs, 2φ: 71/71μs			
Count range	24 bit, 0 to 16,777,215					
Count input	5/12/24VDC		RS422A			
Preset input	Rated voltage: 5/12/24VDC				RS422A	
Coincident output	Number of output: 2 points/channel Output type: Transistor (sink) Rated voltage: 24VDC (10.2 to 30VDC) Rated current: 0.5A/point Response time: 0.1ms					
Remote I/O type	Remote device					
Occupied station numbers	4					
Power supply	24VDC/70mA		24VDC/100mA		24VDC/120mA	

■ Specifications: Remote positioning module

Model	AJ65BT-D75P2-S2
Number of axes	2 axes
Positioning specifications	Same as A1SD75P2-S3, please refer to page 27
Remote I/O type	Remote device
Occupied station numbers	4
Power supply	24VDC/0.3A

AJ65BT-R2 Remote RS232C Interface

Any RS232C equipped devices such as bar code reader or weighing meter, etc. can be connected to CC-Link through this RS232C interface module. Because of the high performance of CC-Link system, those RS232C devices can be located far away from PLC while retaining quick data access time.

AJ65BT-G4 Remote Programming Interface

This is a programming interface that may be located anywhere in the CC-Link system. For adjustment or maintenance activities, a PLC can be accessed from anywhere in the network for up/down loading of program, monitoring, and some testing functions with GPP or MEDOC programming software. Furthermore, access is also given to other PLCs through CC-Link, QnACPU and MELSECNET/10.



■ Specifications: Remote RS232C interface

	Model	AJ65BT-R2
RS232C interface	Number of channels	1 channel
	Communication method	Full duplex
	Synchronization	Asynchronous
	Transmission speed	300/600/1200/2400/4800/9600/19200
	Data format	Start: 1, Data: 7/8, Parity: 0/1, Stop: 1/2
	Error detection	Parity check: None/Even/Odd
	Flow control	DTR/DSR (ER/DR) or DC 1/DC 3
	Cable distance	15m (49.21ft)

■ Specifications: Remote programming interface

Model	AJ65BT-G4
Interface	RS422, channel
Function	Program up/down load, Program monitor, Device data up/down load, Device test
Target PLC type	MELSEC-A, AnS, QnA, Q2AS
Accessible PLC location	Master/local PLC on the same CC-Link PLC on MELSECNET/10 or MELSECNET II through master/local PLC on the same CC-Link Note: Access through MELSECNET/10 or MELSECNET II is available only when the target PLC is QnA/Q2AS.
Remote I/O type	Intelligent device
Occupied station numbers	1 (RX/RX: 32 points each, RWr/RWw: 4 points each)

■ Repeater modules for the CC-Link system

Repeater modules extend the total distance of the CC-link system and can realize T-break connections in it. The modules also simplify wiring in places where it is difficult to set cables.

AJ65SBT-RPS/AJ65SBT-RPG module

- Extends the total distance up to 7.8km with a slower communication speed
- Realization of T-break connections possible

AJ65SBT-RPT module

- Extends the total distance up to 13.2km with a slower communication speed
- Realization of T-break connections possible

AJ65BT-RPI-10A/B module

- Realization of infrared ray transmission from 0m to 100m
- Capable of monitoring the status of transmissions between a Master station and remote I/O stations.

■ Specifications

		AJ65SBT-RPS/AJ65SBT-RPG	AJ65STB-RPT	AJ65BT-RPI-10A/B
CC-Link transmission	Speed	156k/625k/2.5M/5M/10Mbps		156k/625k/2.5Mbps
	Maximum row	3	2	10
	Maximum number of stations	64		
Optical communication	SI/QSI/GI cables	Angle of beam spread: ±2 (transmission distance within 50m) ±1 (transmission distance, 50m to 100m)		—

MELSECNET/MINI-S3

■ AJ71PT32-S3 /AJ71T32-S3 MELSECNET/MINI-S3 master module

The AJ71PT32-S3/AJ71T32-S3 MELSECNET/MINI-S3 master module allows the host QnA/A Series PLC to control up to 64 remote I/O stations connected on the MELSECNET/MINI-S3 networking system. The master module carries out high speed communication processing with the remote units connected to the network it controls. More than one master module can be used per PLC CPU, up to the maximum I/O points of the host CPU.

AJ71PT32-S3 is compatible with both fiber optic and twisted pair cable networks.

AJ71T32-S3 is compatible with twisted pair cable networks.



A High Speed Remote I/O Networking System

■ Up to 512 remote I/O points

The MELSECNET/MINI-S3 remote I/O networking system allows a wide variety of remote I/O modules to be controlled by a central station. A maximum of 64 remote stations can be connected to one network loop, either using fiber optic and/or twisted pair cables. Up to 512 points of data can be refreshed between the master and remote stations in less than 3.2ms.

■ RS232C interface unit

Communications with devices such as bar code readers and ID controllers is possible when connecting this unit to MELSECNET/MINI. Other general purpose devices can also communicate with this unit using a no protocol format.

■ A Series inverters and FX Series PLCs

Both FREQROL A Series inverters and the FX Series PLCs can be connected to MELSECNET/MINI. Inverters can be controlled and monitored from the master station and the FX PLCs can exchange data with the master station.

■ AJ71PT32-S3 /AJ71T32-S3 specifications

Part number	AJ71PT32-S3	AJ71T32-S3
Cable type	Fiber optic or twisted pair	Twisted pair
Maximum number of I/O stations	64	
Maximum number of I/O points	512	
I/O refresh time	3.2 to 18msec (18msec for all stations)	
Communication speed	1.5M baud	
Maximum distance between stations	50m (164ft) for fiber optic, 100m (328ft) for twisted pair (no limit for overall distance)	
Number of I/O points required	32 / 48*	
Current consumption (5VDC)	0.35A	0.30A

*By setup switch

Input Unit Specifications

Class	Model	Input type	No. of input points	Insulation	Rated input voltage	Input current	Operating voltage		Input response time		Input display	External connection	Common connections	Unit consumption current (24V hours)	Number of stations occupied	Weight
							ON voltage	OFF voltage	OFF→ON	ON→OFF						
Outside the panel remote I/O	AJ35PJ-8D	DC (Sink type)	8	Photocoupler	DC12/24V	4/10mA	Over 9.5V	6V or less	10ms or less	10ms or less	LED display	Terminal base connector	8pts/1 common	40mA	1	2.2kg
	50mA															
Compact remote I/O	AJ35PTF-32A	AC	32	Photocoupler	AC100V	10mA	Over 80V	40V or less	15ms or less	20ms or less	LED display	Terminal base connector	16pts/1 common	110mA	4	0.75kg
	AJ35PTF-32D	DC (Sink type)			DC12/24V	3/7mA	Over 9.5V	6V or less	10ms or less	10ms or less				0.70kg		

Input/Output Unit Specifications

Class	Model	Input type	No. of input points	Insulation	Rated input voltage	Input current	Input specifications				Input display	External connection	Common connections		
							Operating voltage		Input response time						
							ON voltage	OFF voltage	OFF→ON	ON→OFF					
Compact remote I/O	AJ35PTF-28AR	AC	16	Photocoupler	AC100V	10mA	80V or more	40V or less	15ms or less	25ms or less	LED display	Terminal base connector	16pts per 1 common		
	AJ35PTF-28AS						DC12/24V	3/7mA	9.5V or more	6V or less				10ms or less	10ms or less
	AJ35PTF-28DR	AC100V							10mA	80V or more				40V or less	15ms or less
	AJ35PTF-28DS				DC12/24V	3/7mA	9.5V or more	6V or less		10ms or less				10ms or less	
	AJ35PTF-28DT	AC100V					10mA	80V or more	40V or less	15ms or less				25ms or less	
	AJ35PTF-56AR				AC	32		AC100V	10mA	80V or more				40V or less	15ms or less
	AJ35PTF-56AS	DC12/24V					3/7mA			9.5V or more				6V or less	10ms or less
	AJ35PTF-56DR				AC100V					10mA				80V or more	40V or less
	AJ35PTF-56DS	DC12/24V					3/7mA	9.5V or more	6V or less					10ms or less	10ms or less
AJ35PTF-56DT	AC100V		10mA	80V or more	40V or less			15ms or less	25ms or less						
Remote I/O split refresh type		AJ35PTF-128DT		DC (Sink type)	64				4/9mA	8V or more	4V or less	107ms or less	107ms or less		

Note: Please see the product manual for more detailed information.

Class	Model	Output type	No. of output points	Insulation	Rated load voltage	Output specifications				Output display	External connection	Common connections	Surge killer	Quick break fuse	Other	Unit consumption current (24V hours)	Number of occupied stations	Weight							
						Maximum load current		Leak current when OFF	Output response time																
						1 point	1 common		OFF→ON	ON→OFF															
Compact remote I/O	AJ35PTF-28AR	Contact	12	Photocoupler	DC24V/AC240V	2A	5A	*2	10ms or less	12ms or less	LED display	Terminal base connector	8pts/3pts/independent per one common	None	None	—	120mA	4	0.78kg						
	AJ35PTF-28AS	Triac				0.6A	2.4A	*3	1ms or less	0.5Hz+1ms or less										8pts/4pts per one common	CR absorber	3.2A	Fuse break display available	140mA	0.65kg
	AJ35PTF-28DR	Contact				2A	5A	*2	10ms or less	12ms or less										8pts/3pts/independent per one common	None	None	—	120mA	0.76kg
	AJ35PTF-28DS	Triac			0.6A	2.4A	*3	1ms or less	0.5Hz+1ms or less	8pts/4pts per one common			CR absorber	3.2A	Fuse break display available	150mA	8	1.10kg							
	AJ35PTF-28DT	Triac (Sink type)			DC12/24V	0.5A	3.2A	*1	2ms or less	2ms or less			8pts/4pts per one common	Varistor	—	110mA			0.65kg						
	AJ35PTF-56AR	Contact			DC24V/AC240V	2A	5A	*2	10ms or less	12ms or less			8pts per one common	None	None	—	150mA	8	1.20kg						
	AJ35PTF-56AS	Triac			AC100-240V	0.6A	2.4A	*3	1ms or less	0.5Hz+1ms or less										CR absorber	3.2A	Fuse break display available	230mA		
	AJ35PTF-56DR	Contact			DC24V/AC240V	2A	5A	*2	10ms or less	12ms or less										None	None	—	150mA		
	AJ35PTF-56DS	Triac			AC100-240V	0.6A	2.4A	*3	1ms or less	0.5Hz+1ms or less										CR absorber	3.2A	Fuse break display available	230mA		
	AJ35PTF-56DT	Triac (Sink type)			DC12/24V	0.5A	3.2A	*1	2ms or less	2ms or less			Varistor	—	—	160mA	1.09kg								
Remote I/O split refresh type	AJ35PTF-128DT	Triac (Sink type)	64		DC12/24V	100mA	2A	*1	(2+I/O refresh type×5) ms or less	Connector	32pts per one common	Clamp diode	—	200mA	4	1.05kg									

Note: 1. Leak current when off *1: 0.1mA or less; *2: none; *3: 3.0mA (AC264V 60Hz)
 2. Please see the product manual for more detailed information.

Output Unit Specifications

Class	Model	Output type	No. of output points	Insulation	Rated load voltage	Maximum load current		Leak current when OFF	Output response time		Output display	External connection	Common connections	Surge killer	Quick break fuse	Other	Unit consumption current (24V hours)	Number of occupied stations	Weight					
						1 point	1 common		OFF→ON	ON→OFF														
External remote I/O	AJ35TJ-8R	Contact	8	Photocoupler	DC24V/AC240V	2A	8A	1.0mA (AC240V 60Hz)	10ms or less	12ms or less	LED display	Terminal base connector	8pts/1 connection	Capacitive varistor	None	—	130mA	1	2.2kg					
	AJ35TJ-8T2	Transistor (Sink type)							DC12/24V	0.5A				3.2A	0.1mA or less	2ms or less	2ms or less			Varistor	2A	Fuse break display available	60mA	
Compact remote I/O	AJ35PTF-24R	Contact	24	Photocoupler	DC24V/AC240V	2A	5A	—	10ms or less	12ms or less	LED display	Terminal base connector	8pts/1 connection	None	None	—	120mA	4	0.80kg					
	AJ35PTF-24S	Transistor							AC100-240V	0.6A				2.4A	3.0mA (AC240V 60Hz)	1ms or less	0.5Hz+1ms or less			CR absorber	3.2A	Fuse break display available	200mA	0.83kg
	AJ35PTF-24T	Transistor (Sink type)							DC12/24V	0.5A				3.2A	0.1mA or less	2ms or less	2ms or less			Varistor	None	—	130mA	0.73kg

MELSECNET I/O LINK

■ I/O LINK

High speed micro area distribution system



■ No additional program

MELSEC-I/O LINK doesn't require any additional knowledge of programming or network parameter configuration. It works just like a standard I/O module programmed with input (X) and output (Y), but actual I/O signals are distributed to remote I/O modules.

■ Up to 128 I/O distribution

MELSEC-I/O LINK can control up to 128 I/O points using 8 point input and output composite remote I/O modules, or up to 64 I/O points can be refreshed for remote I/O modules.

■ High speed I/O refresh

I/O refresh time of MELSEC-I/O LINK is minimized by high speed communication in order to minimize machine control delay. Max. 128 I/O points can be refreshed in approximately 5.4 ms.

■ Applicable cable

Connection by twisted pair cable gives the advantage of low cost in addition to easy wiring.



Flexible configuration

Numbers of I/O points of the remote I/O modules are kept small so that just the necessary number of I/O signals are distributed to locations where control devices are located. In addition, no terminal resistance requirement and the T shape branch feature give maximum flexibility of configuration and layout.

High reliability

Bus topology of MELSEC-I/O LINK gives the advantage of high reliability. Shutdown of one remote I/O module doesn't affect the communications of the others.



AJ51T64 master module specifications

Number of maximum control I/O points	128 I/O points using 8-point I/O combination modules, 64 points using any mix of I/O modules
I/O refresh time	Approx. 5.4msec
External supply voltage	21.6 to 27.6VDC
Transmission speed	38.4k bps (actual 19.2k bps)
Transmission path	Bus (multidrop) form, terminal resistor not required, T-shaped branch connection allowed
Overall distance	Maximum 200m (656.2 ft)
Maximum number of stations	16 stations per master
Communication cable specification	Twisted pair cable or cabtyre cable of minimum 0.5mm ² thickness
Number of I/O points required	64
Current consumption (5VDC)	115mA

Remote input module specifications

Model name	Type	No. of points	Insulation	Rated voltage	Rated current	Operation voltage (V)		Operation voltage (V)		Connection type	Points per common	No. of stations																
						ON	OFF	ON	OFF																			
AJ55TB3-4D	DC input Sink/source	4	Photocoupler	24VDC	7mA	14	6	10	10	Terminal block	4	1																
AJ55TB3-8D		8									8	2																
AJ55TB3-16D		16									16	4																
AJ55TB32-4DT	DC input sink	2									Photocoupler	24VDC	7mA	14	6	10	10	Terminal block	2	1								
AJ55TB32-8DT		4																	4	1								
AJ55TB32-16DT		8																	8	2								
AJ55TB32-4DR	DC input Sink/source	2																	Relay	24VDC 240VAC	2A/pt, 8A/com	10	12	Terminal block	Terminal block	Terminal block	2	1
AJ55TB32-8DR		4																									4	1
AJ55TB32-16DR		8																									8	2

Remote output module specifications

Model name	Type	No. of points	Insulation	Rated voltage	Rated current	Operation voltage (V)		Connection	Points per type	No. of common	Stations											
						ON	OFF															
AJ55TB2-4T	Transistor sink	4	Photocoupler	12/24VDC	0.5A/pt, 2A/com	2	2	Terminal block	4	Zener diode	1											
AJ55TB2-8T		8			0.5A/pt, 4A/com				8		2											
AJ55TB2-16T		16			0.5A/pt, 8A/com				16		4											
AJ55TB2-4R	Relay	4			Relay	24VDC 240VAC	2A/pt, 8A/com		10	12	Terminal block	Terminal block	Terminal block	4	1							
AJ55TB2-8R		8												8	2							
AJ55TB2-16R		16												16	4							
AJ55TB32-4DT	Transistor sink	2					Photocoupler		12/24VDC	0.5A/pt, 1A/com				2	2	Terminal block	Terminal block	Terminal block	2	1		
AJ55TB32-8DT		4								0.5A/pt, 2A/com									4	1		
AJ55TB32-16DT		8								0.5A/pt, 4A/com									8	2		
AJ55TB32-4DR	Relay	2	Relay	24VDC 240VAC				2A/pt, 4A/com		10				12	Terminal block				Terminal block	Terminal block	2	1
AJ55TB32-8DR		4						2A/pt, 8A/com													4	1
AJ55TB32-16DR		8						8													2	

QnA Series Ethernet Modules

■ Ethernet modules

AJ71QE71, AJ71QE71-B5

Features

- Operates on either of 10BASE5 or 10BASE2.
- TCP/IP, UDP/IP protocol support
- Selection of three communication modes
 - Fixed buffer communication
 - Random buffer communication
 - PLC server function
- UDP/IP broadcasting
- PING function
- Connection through routers



■ Fixed buffer communication

AJ71QE71 has eight fixed buffer memories of 1k words each. With use of these memories, this module can send and receive up to 1016 word data per transmissions to/from other PLCs and/or other equipment.

■ Broadcasting function

AJ71QE71 can send up to 2046 bytes of data packet to all other nodes connected on the same Ethernet as an optional function of UDP/IP protocol. With use of this function, emergency information or network common information can be distributed in the network.

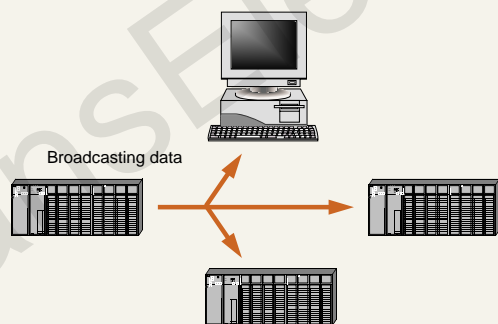

■ PING function

AJ71QE71 can automatically confirm whether the connected node is still alive, by issuing a PING command so that the PLC can take recovery action in case the result of PING is negative.

■ FTP server function

AJ71QE71 supports TCP/IP standard FTP (File Transfer Protocol) function. With this function, a PC can access QnACPU's program files, parameter file and other data files for up/down load.

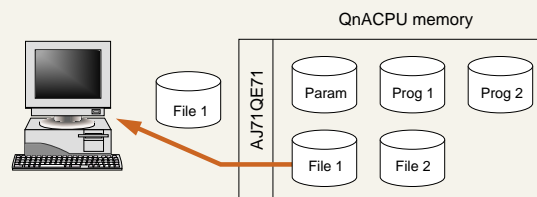

■ Specifications

Item	AJ71QE71	AJ71QE71-B5
Interface	10BASE5, 10BASE2	10BASE5
Protocol	TCP/IP, UDP/IP	
Speed	10 Mbps	
Overall distance	10BASE5:2500 m, 10BASE2: 925 m	
Segment distance	10BASE5:500 m, 10BASE2: 185 m	
No. of nodes per segment	10BASE5:100 , 10BASE2: 30	
Min. node distance	10BASE5: 2.5 m, 10BASE2: 0.5 m	
Send/receive buffer	Fixed buffer: 1k words x 8, Random buffer: 6k words	
Cable	10BASE5: Ethernet cable, 10BASE2: RG58A/U	
Required accessories	10BASE5: Transceiver, AUI cable, 12VDC power supply 10BASE2: None	
EEPROM	Up to 10,000 times writing	
Occupied I/O points	32	
5VDC consumption	0.8A	

A Series Ethernet Interface Modules

■ AJ71E71-S3 Ethernet module

The AJ71E71-S3 is an ethernet network interface module which allows the host PLC CPU to be directly connected to an ethernet network system. It supports TCP/IP and UDP/IP protocols with the possibility of using either ethernet 10 BASE5 or 10 BASE2 simply by switch selection. The interface conforms with IEEE standard 802.3 (CSMA/CD) and features transmission speeds of up to 10M bps.

Device reading/writing, program uploading/downloading and remote run/stop controlling are all possible using dedicated instructions from any node on the ethernet system. Communications with other PLCs connected onto MELSECNET II and MELSECNET/10 is also possible.



■ AJ71E71 specifications

Part number	AJ71E71-S3
Applicable QnA/A Series PLC	QnA/A Series
Number of I/O points required	32
Interface	Conforms to ethernet I/F (10 BASE5) and thin wire ethernet I/F (10 BASE2)
Buffer memory	Fixed buffer, 2k bytes × 8 Random buffer, 12k bytes
Transmission path	Base band
Communication speed	10M bps

■ System configuration example

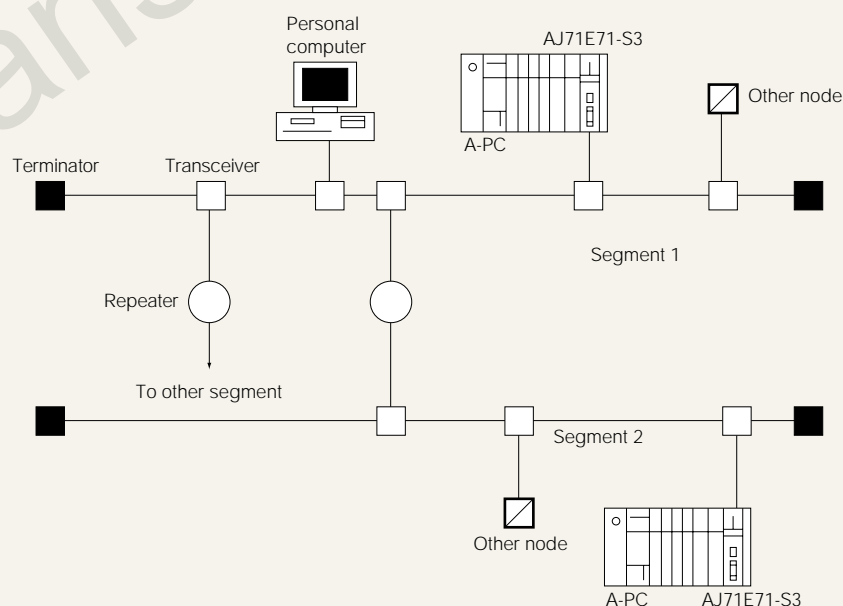

QnA Series Communication Modules

Serial Communication modules

AJ71QC24N, AJ71QC24N-R2, AJ71QC24N-R4



Features

- A total of two channels of RS232C, RS422 and RS422/485 communication interface ports
- Both ports can operate as linked or independently.
- Choice of Dedicated protocol mode, Non-protocol mode, or Bi-directional protocol mode
- Entire QnA device memory area and program area can be accessed with the dedicated protocol mode.
- User definable frame is automatically added to transmission data.
- Up to 115.2k bps of high speed transmission.

ASCII/Binary code selection

In most cases, ASCII code is used for communicating with PCs, sensors, and serial printers. Included in AJ71QC24 modules, however, is the option to use binary code instead of ASCII for communication with PCs. Since a binary code data frame is half the size of an ASCII code data frame, data transmission time is cut in half.

Transparency code: When binary code is used for communication, a transparency code can be registered so that binary data having the same code as a frame termination code can be transmitted.

Independent/Link operation

Two communication port channels can operate either independently or linked.

Independent operation: Communication speed, data format, and protocol can be independently assigned to each channel for different applications.

Linked operation: In this mode, data received at Ch1 is retransmitted from Ch2 and data received at Ch2 is retransmitted from Ch1. This mode can be selected when multi-drop PLC control under one PC is required.

Specifications

Item		AJ71QC24N	AJ71QC24N-R2	
Interface	1st ch	RS232C	RS232C	
	2nd ch	RS422/485	RS232C	
Communication method	Dedicated protocol	Half-duplex (Full/half duplex in case of using On-demand function)		
	Non-protocol	Full/half duplex		
	Bi-directional protocol	Full/half duplex		
Synchronization		USART		
Speed		AJ71QC24N, AJ71QC24N-R2, AJ71QC24N-R4: 300 to 115,200 bps		
Data format	Start bit	1		
	Data bit	7, 8		
	Parity bit	None, Even, Odd		
	Stop bit	1, 2		
Access cycle	Dedicated protocol	1 access per END processing (can be changed by parameter setting)		
	Non-protocol	Upon Send request, and data receive		
	Bi-directional protocol			
Error detection	Parity check	Available for all protocols		
	Check sum	Available for Dedicated/Bi-directional protocols Selected in User definable frame for Non-protocol		
Communication control			RS232	RS422
	DTR/DSR control	Yes	Yes	Yes
	RS/CS control	Yes	Yes	No
	CD control	Yes	Yes	No
	DC code control	Yes	Yes	Yes
EEPROM rewrite		Up to 100,000 times		
Distance		RS232C: 15 m, RS422/485: 1200 m		
5VDC consumption		0.3A		0.2A
Occupied I/O points		32		

A Series Communication Modules

Special communication modules



A computer interface module for linking to computers and other intelligent devices

The AJ71UC24 computer interface modules allow external intelligent devices such as computers, to communicate with the PLC CPU. Sequence programs, bit devices, word devices, parameters etc. can be monitored or written to using serial communications which conform to RS232C and RS422 standards. Multi-drop systems can be configured

using these modules for linking up to 32 PLC stations and allowing access to all 32 from one centralized point. Each module can operate in either one of four fixed protocol communications modes or in no protocol mode. Each has its own built-in buffer memory for the reading and writing of data.

AJ71UC24 computer interface module specifications

Part number	AJ71UC24
Applicable A Series PLC	AnU, AnA and AnN Series
Interface	1 × RS232C channel, 1 × RS422 channel
Transmission system	Half duplex communication system, dedicated protocol
Synchronization method	Asynchronous
Transmission speed	300, 600, 1200, 2400, 4800, 9600, 19200 bps (switch selectable)
Data format	1 start bit, 7 or 8 data bits, 1 or none parity bit, 1 or 2 stop bit (switch selectable)
Access cycle	Made at END of sequence program. Access time is equal to scan time
Error detection	Parity check present odd/even or absent, sum check present or absent
ER/DR control	Present
DC1/DC3	Absent
Transmission distance	Up to 15m for RS232C, Up to 500m for RS422
Transmission code	ASCII
I/O points required	32 points

System configuration example

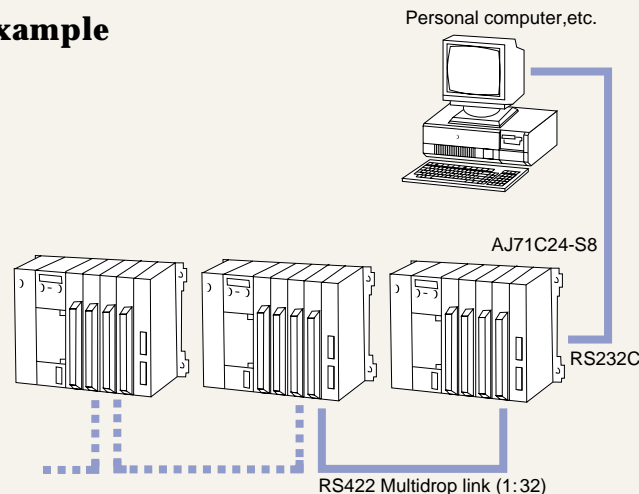

PROFIBUS Interface Modules

■ PROFIBUS DP/FMS, AJ71PB92D and AJ71PB96F

AJ71PB92D and AJ71PB96F modules allow connection to PROFIBUS DP and FMS network respectively. Now A Series PLC's can be used in conjunction with other PROFIBUS compatible equipment to provide a standard open network architecture while maintaining all the advantages and ease of use of the A Series.

■ Features

Conforms to DIN 19245

Utility software package (MELSEC ProfiMap*)

AJ71PB96F modules have a number of special functions including domain control, PI control, PutOD, and FMA7 service.

*This software package contains the following features:

- Editor windows (fully supports Copy and Paste functions)
- Network parameter checking functions
- Download/Upload/Verify possibilities to the network modules
- Monitor windows
- Import/Export functions
- Parameter file handling on floppy disk/hard disk
- Parameter print feature

- Independent screen resolution



■ AJ71PB92D, AJ71PB96F specifications

Item	AJ71PB92D		AJ71PB96F	
Electrical standards and characteristics	Conforms to EIA-RS485			
Cable	Shielded twisted cable			
Network configuration	Bus type (tree type if repeaters are used)			
Communication protocol	Token passing (between masters), Polling (between master and slave)			
Encoding method	NRZ			
Transmission speed/ Maximum transmission distance	Speed	Distance (m/segments)	Speed	Distance (m/segments)
	9.6kbps	1200	9.6kbps	1200
	19.2kbps		19.2kbps	
	93.75kbps		93.75kbps	
	187.5kbps	1000	187.5kbps	600
	500kbps	400	500kbps	200
	1500kbps	200	1500kbps	100
	3Mbps	100	—	—
	6Mbps			
12Mbps				
Maximum transmission distance	4800m (15,748 ft)			
Maximum number of repeaters per network	3			
Maximum number of stations segment	32 stations			
Maximum number of stations connected	—		32	
Maximum number of slave/master station	60		—	
Number of connected nodes	32, 62 (1), 92 (2), 126 (3)			
Transmissible data	32 bytes/station		Maximum 241 bytes/transfer	
I/O Points	32			

DEVICENET Interface Modules

AJ71DN91 DeviceNet Master Module

The AJ71DN91 module allows connection to a DeviceNet system. This unit functions as a DeviceNet master and can control up to 63 slave stations over a distance of up to 500m.

- Selectable communication speed
- Recognized open network standard
- Wide range of DeviceNet compatible devices available



■ AJ71DN91 specifications

Item			Specification			
Communication specifications	By node type		Group 2 dedicated client			
	Settable station numbers		0 to 63			
	Max. number of slaves to communicate with		63			
	Data volume	I/O communication	Send	2048 points (256 bytes)		
			Receive	2048 points (256 bytes)		
		Message communication	Send	240 bytes		
			Receive	240 bytes		
	Communication speed		Select 125, 250 or 500k baud			
	Max. cable length	Communication speed	Trunk line max. transfer distance	Drop line		Total
				Thick cable	Thin cable	
125k baud			500m (1,640ft)	100m (328ft)	6m (20ft)	
250k baud	250m (820ft)			78m (256ft)		
500k baud	100m (328ft)			39m (128ft)		
Amperage consumption on the network (mA)		26.5				
Number of I/O points required		32				
Current consumption 5VDC (A)		0.24				

MODBUS Interface Modules

■ AJ71UC24-S2

MODBUS interface modules

The AJ71UC24-S2 modules allow the QnA/A Series PLC to be connected to the MODBUS network. These modules under a MODBUS network system act as a slave station to write and read data to/from the ACPU memory in accordance with instructions given from a master system. In addition to the MODBUS protocol, these modules also support extended functions equivalent to the dedicated protocols of standard AJ71UC24 modules. This feature gives more flexibility of data acquisition and control by a master system.

- Support MODBUS slave station protocols.
- Function code 1 to 21 are supported
- Two transmission modes of RTU or ASCII



■ Specifications

Item	Specifications	
Interface	RS232C: 1 channel, RS422/485: 1 channel	
Transmission mode	Half-duplex	
Synchronous mode	Start-stop synchronization	
Transmission speed	300,600,1200,2400,4800,9600,19200 bps	
Data format	ASCII	RTU
Start bit	1	
Data bits	7	8
Parity bit	1 or none	
Stop bit	1 or 2	
Error detection	Parity check (Even/ Odd)	
Frame check sequence	LRC	CRC
Distance	RS232C: Up to 15 m (49.2 ft) RS422/485: Up to 500 m (1,640 ft)	
Current consumption (DC5V)	0.1A	
Number of I/O points required	32	

■ Supported MODBUS functions

Code	Function
01	Read coil status
03	Read holding register
05	Reset single coil
06	Reset single register
07	Read exception status
08	Loopback test
11	Fetch event counter communication
12	Fetch event communication event log
15	Force multiple coils
16	Force multiple register
17	Report slave ID
20	Read general reference-584 only
21	Write general reference-584 only

■ Accessible device range

MODBUS reference	Device	Range
Coil	Y	Y0 to 1FFF
	X	X0 to 1FFF
	B	B0 to B1FFF
	M	M0 to 8192
	F	F0 to 2047
	T (Coil)	T0 to 2047
	T (Contact)	T0 to 2047
	C (Coil)	C0 to 1023
	C (Contact)	C0 to 1023
	Special M	M9000 to 9255
Holding register	D	D0 to 8191
	W	W0 to 1FFF
	R	R0 to 8191
	T (Value)	T0 to 2047
	C (Value)	C0 to 1023
	Special D	D9000 to 9255

PC Option Boards

Overview

The A70BDE and A80BDE option boards are for use with an IBM® AT or 100% compatible computer. The option boards perform a variety of functions, including functioning as a CPU board (A80BDE-A2USH-S1) which performs the same role as an A2USH-S1 CPU, functioning as a network board (A70BDE-J71QLP23, etc.), which turns the computer into a regular station of MELSECNET/10, and functioning as a CC-Link board (A80BDE-J61BT11, etc.), which connects the computer to the CC-Link system. These option boards allow for the easy integration of PLCs and PC computers.

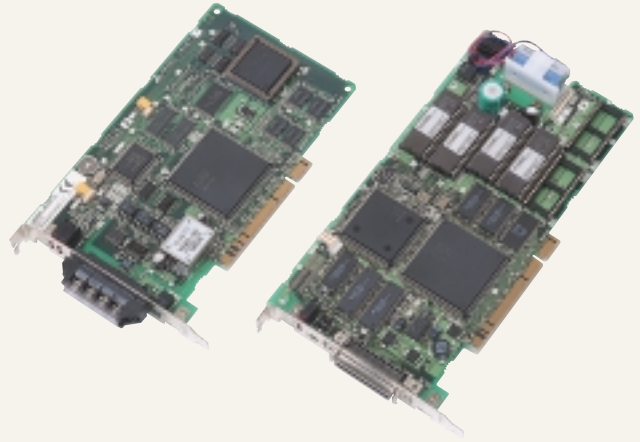

A70BDE and A80BDE option board specifications

Part number	A70BDE-J71QLP23GE	A70BDE-J71QLP23	A70BDE-J71QBR13	A80BDE-J61BT13	A80BDE-J61BT11	A70BD-J71AP23
Type	NET/10 board			CC-Link board		MELSECNET II board
Connection cable	GI-50/125	SI-200/220 QSI-185/230	3C-2V, 5C-2V or equivalent	twist cable with field		SI-200/250
Transmission speed	10Mbps (equivalent to 200Mbps in multiple transmission)		10Mbps	156kbps, 625bps, 2.5Mbps, 5Mbps, 10Mbps		1.25MB
Communication system	Token ring system		Token bus system	Polling		Bit serial
Maximum number of stations	64 (1 control station; 63 ordinary stations)		32 (1 control station: 31 ordinary stations)	64		65 (1 master; 64 others)
Compatible stations	Ordinary			Local	Master/Local	Local
Loading slot	ISA bus slot			PCI bus slot		ISA bus slot
Number of slots occupied	1 slot					
RAS function	Loopback function, automatic return function, loop monitoring function, self-diagnostic function			Offline test function, automatic return function, self-diagnostic function		
Software	SW□DNF-MNET10 software (driver), Windows95, Windows98, Microsoft MS-DOS-6.2			Windows95, Windows98 for local stations, WindowsNT for master stations		SW□DNF-MNET10 software (driver), Windows95, Windows98, Microsoft MS-DOS-6.2

Programming Units

■ A7PU handy programming units

The A7PU is a powerful, small programming device which can be used to compile, monitor and edit programs. It is a handy programming unit which can be used as either a hand held unit or as an interface unit for the programming of all the MELSEC A PLCs. It is capable of displaying two lines of program at a time and is connected to the PLC via an RS422 interface. When used in conjunction with an audio cassette, it can store and maintain programs and data.



■ A6WU EPROM writer

The A6WU EPROM writer is designed to be used with type 2764, 27128, and 27256 EPROMs. It has an LCD display, and can be operated easily using its dialogue mode. Its functions enable reading, writing, verify and erase checking of the EPROMs. It is connected to the PLC via an RS422 interface and can be hand held or clipped on to the PLC CPU's programming port.



■ A8PUE Peripheral Device

The A8PUE is a peripheral device that is used with the MELSEC-A series of general-purpose programmable controllers. It can read from and write to sequence programs in a MELSEC-A series PC CPU.

The A8PUE is also used for monitoring and testing devices. Follow the procedures in this manual when using the A7PUS to perform program I/O, as well as inspection and maintenance.

■ A8PUE specifications

Item	Specifications
Connected module	ACPU
Power, current consumption	Power supplied from connected ACPUC (5 VDC, 0.4 A)
Connection method	Add-on (Attached directly to the ACPUC)
	Hand-held (Connected via RS-422 cable)
LCD display	Display of 4 lines × 20 characters (with cursor)
Operating method	Consists of 54 operation keys (covered with polyurethane film)
Key operation check	Buzzer
Display lifespan	100000 hours or more (when using the unit at 15 to 35°C ambient temperature and 65% RH or less ambient humidity)
Backlight lifespan	50000 hours or more (when using the unit at 25°C operating ambient temperature) If ON, goes OFF if a key has not been input for 10 minutes.
Keypad lifespan	1000000 times
Outside dimensions H × W × D mm (inch)	188 (7.40) × 95 (3.74) × 44.5 (1.75)
	When installed onto an ACPUC, the depth is 37.5 (1.48).

Modem Interface Modules

Q6TEL

Features

- The QnA/A switch allows for connection to all QnA Series and A Series sequencer CPUs.
- Sequencer maintenance via remote access GPP peripheral devices such as DOS/V personal computers can be connected with the sequencer via a phone line allowing monitoring, testing, programming, and other revisions to be conducted at long distances. GPP peripheral devices such as DOS/V computers, and the sequencer when connected by RS-422 operate with the same GPP function.
- Notification System
When an abnormality occurs in the sequencer or trouble is detected at the operation facilities, notification and a message of up to 10 characters will be sent from Q6TEL to your pager.
- Password Registration
When you register your password with Q6TEL, only authorized parties will be allowed remote access.
- RS-232C-RS-422 Conversion Function
When Q6TEL is installed to the sequencer, peripheral devices can be connected with RS-232C (See Performance Specifications) cable making monitoring, testing, program scheduling and other changes to the GPP function possible. (An RS232C-RS422 Converter and conversion cable is not required.)



■ Q6TEL modem interface unit

Item	Specifications	
A/QnA conversion switch	Set to "QnA"	Set to "A"
Applicable CPUs	All of the QnA Series	All of the A Series
CPU connection method	Add-on method	Add-on method for A2CCPU and A2CJCPU
Connection cable	Local Devices Connection: User Supplied (Compatible with AC30N2(A))	
	Modem Connection: cable included with modem or specified cable	
Interface	RS232C (Modem or DOS/V computer used for connecting)	
Telephone circuit	Analog 2 line type, ISDN	
Number of notification items	10 items (Including Q6TEL transmission)	6 items (pager notification only)
Pager notification message length	fixed or variable	fixed
Consumption current (DC5V)	0.15A (current from CPU unit)	
Outer dimensions	102 (4.02) H × 109 (4.29) W × 21 (0.83) D mm (inch)	
Weight	0.20kg	
Software package	SW□D5C-GPPW (□: version 2 or higher) Model GPP Software Package	
	SW□D5C-GPPW (□: version 3 or higher) Model GPP Software Package or SW2SRXV/NX/IVD-GPPA Model GPP Software Package plus SW2SRXV/NX/IVD-GPPATEL Model GPP Software Package	

● Telephone Line Restrictions

Because data may be altered or the connection severed due to an incoming call alert signal, please refrain from using call waiting.

Because the connection may be severed when a receiver is picked up, avoid using lines to which multiple phones are connected.

■ SW□D5C-GPPW

(□: version 3 or higher) model

Item	Function
Circuit connection	Connect via a telephone circuit to the location you designate.
Circuit disconnection	Disconnect the circuit
Telephone number registration	Set the location and telephone number for the connection being made. A maximum of 250 circuits can be used.
System settings	Set the modem used to make the connection and the location where log files are to be housed.
Send and receive files	Send and Receive files between GPP peripheral devices such as DOS/V computers. *Not supported by the Q6TEL function.
Prepare data for Q6TEL	Configure the connecting modem, password, and notifications registered with Q6TEL and register with A6TEL.

■ Additional modem information

● Modem Specifications

Transmission Standards: Transmission speed depends on the modem

Error Detection: MNP Class 4/10 or V.42

Data Compression: MNP Class 5 or ITU-T V.42bis

NCU Type: AT Command

Both DIP switch and AT command (for use with terminal software) can be used to independently change the DR signal to H status.

● Connection Cable

RS-232C cable included with the modem or specified cable can be used. (See Performance Specifications)

● Q6TEL: 25 pins; D sub-connector

● Personal Computer: 9 pins; D sub-connector

● When Using a Cell Phone

When the recipient is using a cell phone the error detection function requires an MNP Class 10 Support Modem. It may not function properly when the line quality is poor.

If when using a cell phone, messages are set to be received automatically, use a transmission unit for cell phones that can manage such a function.

Programming Software

GX Developer (SW□D5C-GPPW-E) **MELSEC Programming software**

GX Developer is a powerful Windows based programming software which replaces the previous DOS version MELSEC MEDOC, GPPA and GPPQ software packages. However, GX Developer is more than just an upgrade. By taking full advantage of the Windows environment and adding many useful functions, the GX Developer programming environ-

ment is easy to use and new program development is both fast and efficient.

GX Developer supports programming of all current MELSEC PLC CPUs, so project design using a variety of CPU types and series is possible.

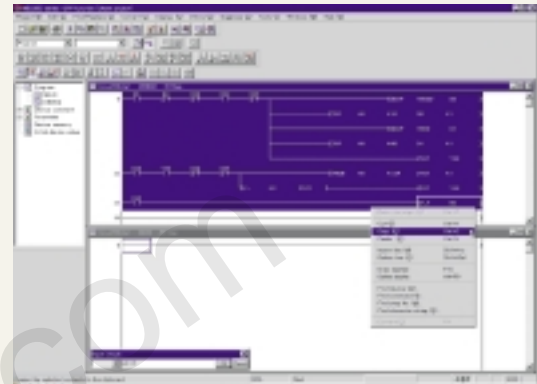
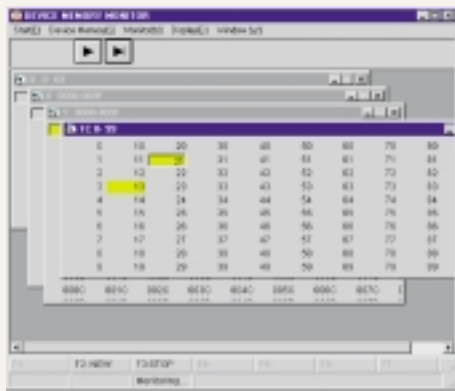

■ **Programming languages**

In addition to ladder and list programming languages, SFC (MELSAP2/MELSAP3) is supported. With the Windows environment, all these program types can be created and edited easily with the mouse or keyboard.

■ **Easy program creation and editing**

GX Developer supports standard cut, copy and paste operations. This allows greater ease of use and the ability to edit data in other applications. For instance, comment data can be edited in Word or Excel and directly pasted into the comment edit screen.

■ **Full diagnostic capability**

In the event of an operation error online diagnostics can quickly pin-point the problem. The GX Developer helpfile further assists to resolve hardware and software problems without the need for a manual.

■ **CC-Link support**

Operation monitoring, link status and testing have been enabled with the A/QnA Series. The CC-Link unit's link status and error status can be monitored with the A Series/QnA Series, and a line test to check for faulty stations can be carried out. Also, the CC-Link personal computer interface board (A80BDE-J61BT13) is also compatible with GX Developer.

■ **Backward compatibility**

GX Developer not only supports downloading existing projects from the PLC CPU but also allows direct conversion of existing DOS based software GPPA, GPPQ and MELSEC MEDOC FXGP (Win) and FXGP (DOS) data.

■ **Multi-windows, Multi sessions**

Use of both multiple windows (e.g. different programs within the same project) and multiple sessions (e.g. more than one iteration of GX Developer running on a single PC) gives greater scope to share common data between program and projects quickly and easily. Also programming productivity is enhanced with this function. For example, a programmer can monitor one project while editing another.

■ **Modem function**

Communication is possible via the A6TEL modem interface unit (A Series only) or the Q6TEL modem interface unit (A Series/QnA Series). By using a modem, remote PLCs can be serviced.

■ **Software family**

While GX Developer can be used by itself to create and manage programs and projects, other software packages have been produced to work in conjunction with GX Developer, further enhancing programming and maintainability.

GX Simulator (SW□D5C-LLT-E) **MELSEC Simulation software**

Programs can now be tested and checked without the need to download to a CPU. This useful function allows simulation of the sequence program within the Windows environment. Program execution and timing can be easily seen and because the display method is the same as the standard monitoring function in GX Developer, the display format is both familiar and easy to understand.

A timing chart can be displayed with the ladder logic test tool function software package allowing program operation to be confirmed graphically.

GX Converter (SW□D5C-CNVW-E) MELSEC Data conversion software

With this data conversion software package, comments created in CSV format (Text data/Excel data (CSV format data) compatible), etc., can be used. By using this data conversion software package, the command lists from the “read/write of other formats” menu can be used for device comment data. Furthermore, the GX Developer command lists and device comments can be converted and used in the list created by the user.

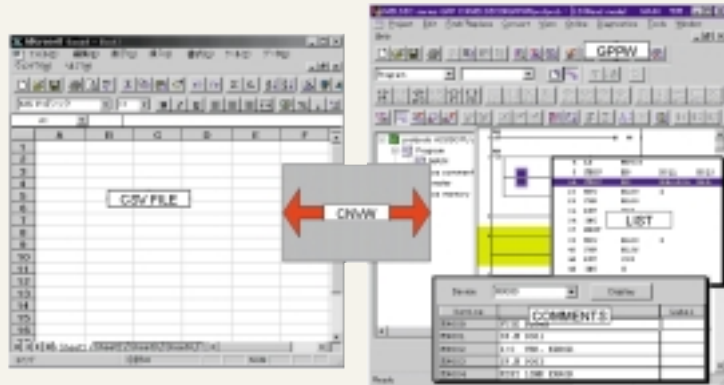

MX Links (SW□D5C-CSKP-E) Basic communication support tool

Communication with the PLC CPU via a variety of connection methods is supported with the MX Links software tool. PLC data can be collected via RS-232C, RS-422, Ethernet, MELSECNET/10 or CC-Link and used within a personal computer by other applications (e.g. Visual Basic V4.0/5.0/6.0, Visual C++ V4.2/5.0/6.0). A special library of commands, known as the MELSEC data link library, are available to allow the following functions:

Function name	Function
mdOpen	Initialize and open the selected communication line channel
mdClose	Close the selected communication line channel
mdSend	Write the designated No. of bytes to the head of the device in a batch
mdReceive	Read the designated No. of bytes from the head of the device in a batch
mdRandR	Read the randomly designed device
mdRandW	Write the randomly designed device
mdDevSet	Set (turn ON) the designated device
mdDevRst	Reset (turn OFF) the designated device
mdInit	Refresh the PLC information when the PLC parameters, etc., have been changed
mdControl	Carry out remote RUN/STOP/PAUSE of the designated PLC CPU
mdTypeRead	Read the designated PLC CPU type

MX Monitor (SW□D5C-XMOP-E) Monitoring tool

Visual Basic support is further enhanced with the MX Monitor monitoring tool. Acting as a custom tool within Visual Basic, (V4.0/5.0/6.0) it is easy to create monitoring screens that will reflect changes of status and data within the connected PLC. Functions such as figure display, value display, level display and trend graph are provided among 23 types of custom controls. A graphical monitoring application can be created just by pasting the MX Monitor controls into a VB form and setting the properties.

MX Chart (SW□D5C-OLEX-E) Excel communication support tool

The MX Chart software tool allows PLC data and Microsoft Excel 95 Ver. 7 or Excel 97 data to be exchanged with no extra PLC programming required. The functions of this software tool are accessed as Excel macros. These macros can be invoked to allow Excel to read from or write to the PLC CPU.

[Operating Environment for GX Developer, GX Simulator, MX Links, MX Chart and MX Monitor]

OS	MS-Windows 95 (English version) MS-Windows 98 (English version) MS-Windows NT Workstation 4.0 (English version)
CPU	Pentium 133MHz or more is recommend
Memory	32MB or more is recommended
Hard disk space	50MB or more
Disk drive	3.5-inch (1.44MB) floppy disk drive required CD-ROM disk drive
Display	Resolution 800×600 pixels or more

Programming Software

■ MELSEC MEDOC plus, IEC compatible programming software

MELSEC MEDOC plus is the programming software for all MELSEC series PLCs. This software has been developed to improve productivity of programming by incorporation of IEC61131 standards.

The requirements to PLC controlled machinery and equipment are becoming more sophisticated. Also, PLC programs are becoming larger and more complicated. This results in a longer time required for PLC programming. In addition, large programs are not only a problem for designers, but also for maintenance people. They have to read and understand large PLC programs. Everybody wants to reduce programming time, and split large programs into several modules for easy understanding.

This software, compliant with the IEC61131 standard, provides an environment of structured programming. This allows large programs consisting of several programming modules to be constructed. In addition, compatibility with Windows provides a user friendly environment.

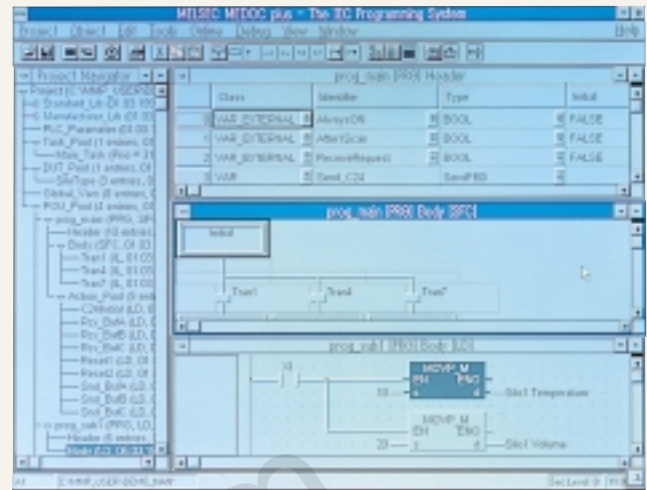

■ IEC61131 compatible

MELSEC MEDOC plus is compatible with the programming methods stated in IEC61131 standards. Functions such as programming language, ladder, instruction list, function block diagram, user defined function, and sequential flow chart are all provided. Because this software is designed to comply with pre-defined standards and programming principles, even users who are not familiar with MELSEC programming and language can use this software with a minimum amount of PLC hardware knowledge.

■ Structured programming

Sequential flow chart and task constructions of the software allow a large program consisting of multiple program modules based on each machine operation. Since each program module is fairly small, they are easier to understand and debug than if the entire program had to be dealt with.

■ Compatible CPUs

MELSEC MEDOC plus is compatible with the following MELSEC Series PLCs.

FX0/FX0N/FX/FX2C/FXU/FX0S/FX2NC/FX2N
 A1S(S1)/A2S(S1)/A1SH/A1SJH/A2SH(S1)
 A2AS(S1)/A2US(S1/S30/S60)/A2A(S1)/A3A
 A2U(S1)/A3U/A1N/A2N/A3N/A2C
 Q2A(S1)/Q2AS(S1)/Q3A/Q4A/Q4AR

Includes QnA(S)CPU H-types.

■ Hardware requirements

OS	Windows 3.1	Windows 95/98	WindowsNT
CPU	386DX or high (Recommended Pentium or higher)		
Memory	4MB (Recommended 16MB)	Recommended 32MB	Recommended 64MB
Hard Disk	20MB free	40MB free	40MB free
Monitor	VGA compatible graphics adapter (Recommended: 1024×768, 256 colors)		
Other	Mouse, Serial port × 1, printer port and printer, CD-ROM drive		

■ Program library

Once a program module is created for a project, the module can be stored in a library. When a projects similar to one created previously, pre-made program blocks can be re-used. This feature not only reduces program development time, but also reduces programming errors and debugging because proven modules are used.

■ Password protection

Multiple levels of passwords can be registered in a program providing protection from tampering.

■ MELSEC compatible mode

For users who are familiar with MELSEC programming and want to continue this programming method, the software offers a MELSEC compatible mode. With this mode, the users can write a program with the MELSEC instruction set.

Human Machine Interface

■ GOT-900 series common features

- High speed response
GOT can be directly connected to the base of Mitsubishi PLC's base which keeps transmission at very high speeds. (It can also be connected to the base of the PLCs of some other manufacturers.)
- Editing, debugging and maintenance
 - Change sequence program at list mode
 - System monitoring
 - Network monitoring
 - Operating check of intelligent modules
 - Monitor and change devices and counters
- OS can be installed into GOT from a computer making it easy to upgrade versions and performance.
- Simulation function
Through utilizing GT works, simulation from design graphics to debugging in a computer has been made possible.

A985GOT



A975GOT



A956WGOT



■ Features

- Connection to 4 videos and the simultaneous display of 4 pictures is possible.
- With clip mode, it is possible to display only the desired portions of a particular graphic.
- 720×480 dots wide show
- Changeable window size
- Highlights 256 colors
- Superior maintenance function
- Compact size
- Voice output function
- Larger amounts of data can be displayed thanks to the extra wide window (1.5 times larger than the 6 inch type in width).
- Highlights 255 colors
- System monitor
- Equipped with a compact flash card interface for large data storage

Available soon

■ Specifications

Item		A985GOT-TBD-V A985GOT-TBA-V	A975GOT-TBA-EU	A970GOT-TBA-EU	A956WGOT-TBD
Display section	Type	TFT color liquid crystal			
	Resolution	800×600	640×480	640×480	480×234
	Display color	256	256	16	256
	Brightness (cd/m ²)	350 (8 adjustable scales)			300 (8 adjustable scales)
Number of touch keys (points)		1900 (38 rows×50 columns)	1200 (30 rows×40 columns)		450 (15 rows×30 columns)
User memory		1MB (up to 9Mb possible)			
Dimensions W×H×D mm (inch)		312 (12.28)×238 (9.37)×49 (1.93)	297 (11.69)×208 (8.19)×46 (1.81)		215 (8.46)×133 (5.24)×70.8 (2.79)

Please refer to the GOT catalog for details.

Standards and Dimensions

Foreign Safety Standards



Beginning with UL Certification, we have met the safety standards of numerous regulatory agencies.

Standard	Type of Certification	Products Covered
UL	UL508 (America)	A GOT
cUL	CSA (Canada)	A GOT
CE	LVD, EMC (Europe)	QnA A GOT
Lloyd's Register	LR Ship Classification Certification	QnA A
DNV	Norway's Ship Classification Certification	A
NK	Japan's Ship Classification Certification	QnA A

QnA

units: mm (inch)

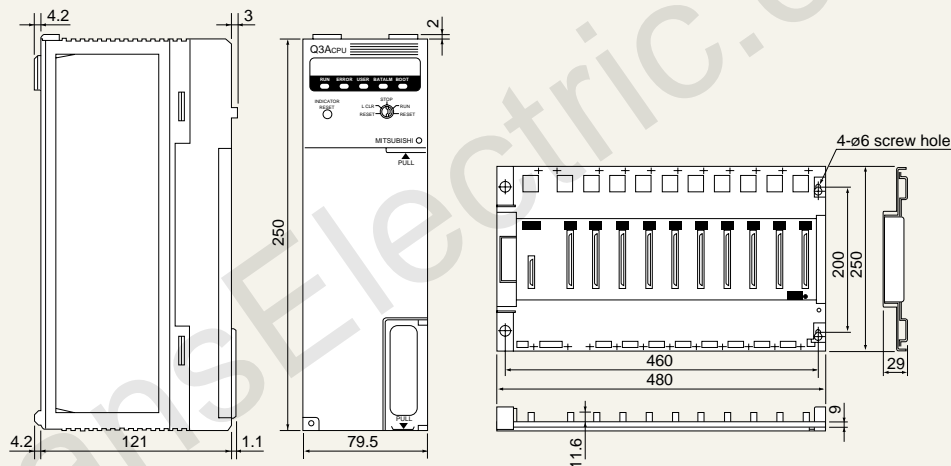

Model	Width mm (inch)
A32B	247 (9.72)
A35B	382 (15.04)
A38B-A38HB	480 (18.90)
A52B	183 (7.20)
A55B	297 (11.70)
A58B	411 (16.18)
A62B	238 (9.37)
A65B	352 (13.86)
A86B	466 (18.35)

Q4AR

A32RB/A33RB

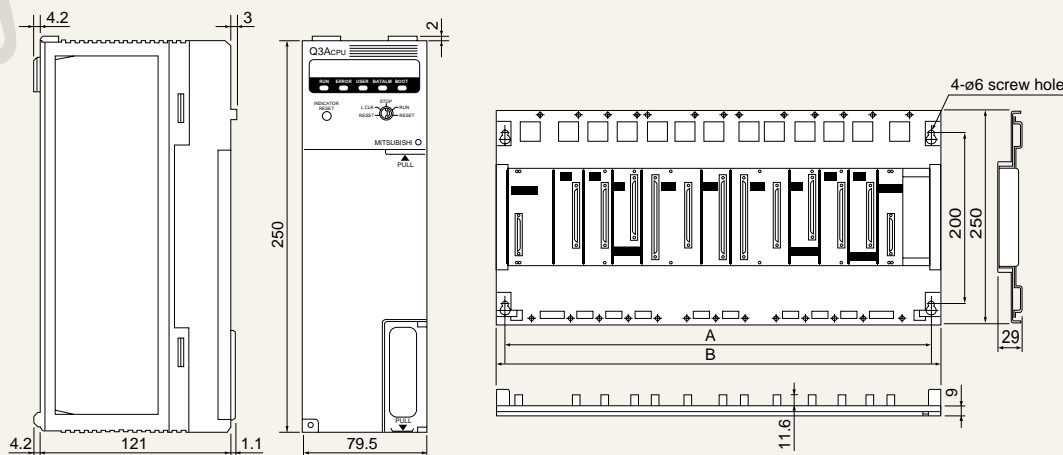

Model	Width mm (inch)		Number of slots
	A	B	
A32RB	474 (18.66)	494 (19.45)	2
A33RB	570 (22.44)	570 (22.44)	3

Dimensions

■ A37RHB

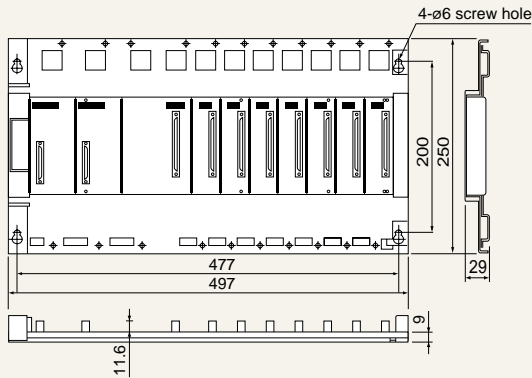

■ A68RB

units: mm (inch)

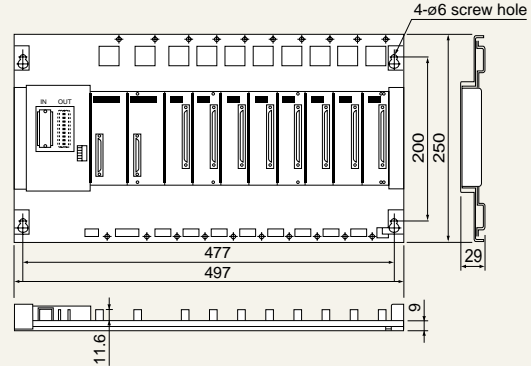

■ AnU, AnA and AnN

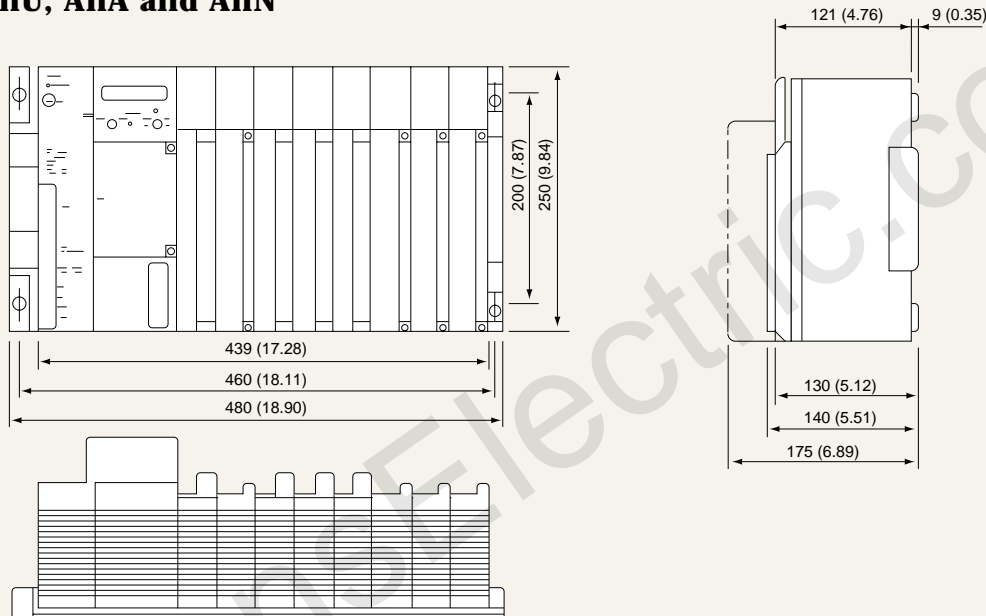

■ MELSEC-I/O LINK remote I/O module

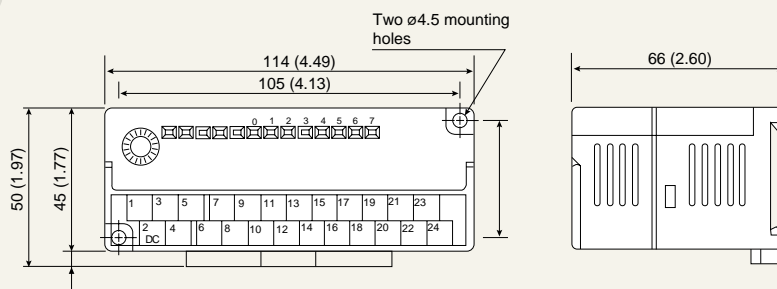

Width mm (inch)

4 point remote I/O	8 point remote I/O	16 point remote I/O
220 (8.66)	225 (8.86)	325 (12.8)

Product Listing

Type	Model	Specifications	QnACPU	ACPU
			Compatibility	
QnA Series				
QnACPU modules	Q2ACPU	Program capacity 28k steps, 512 I/O points	✓	—
	Q2ACPU-S1	Program capacity 60k steps, 1024 I/O points	✓	—
	Q3ACPU	Program capacity 92k steps, 2048 I/O points	✓	—
	Q4ACPU	Program capacity 128k steps, 4096 I/O points	✓	—
	Q4ARCPU	Program capacity 128K steps, 4096 I/O points	✓	—
Main base (High speed modules)	A38HB	8 I/O, CPU & power supply slots, high speed access time	✓	—
	A38HBEU	8 I/O, CPU & power supply slots, high speed access time, CE compliance	✓	—
Serial communication modules	AJ71QC24	RS232 & RS422/485 I/F	✓	—
	AJ71QC24N	RS232C & RS422 I/F	✓	—
	AJ71QC24-R2	RS232C I/F 2 ch	✓	—
	AJ71QC24N-R2	RS232C I/F 2 ch	✓	—
	AJ71QC24-R4	RS232C I/F	✓	—
	AJ71QC24N-R4	RS422 & RS422/485 I/F	✓	—
MELSECNET/10 modules	AJ71QLP21	MELSECNET/10 master/local, SI-200/250 fiber optic	✓	—
	AJ71QLP21S	MELSECNET/10 master/local, SI-200/250 fiber optic, external power input	✓	—
	AJ71QLP21GE	MELSECNET/10 master/local, GI-50/125 Type fiber optic	✓	—
	AJ71QBR11	MELSECNET/10 master/local, coaxial	✓	—
	AJ71QLR21	MELSECNET/10 master/local, coaxial loop	✓	—
	AJ72QLP25	MELSECNET/10 remote I/O controller, SI-200/250 fiber optic	✓	—
	AJ72QLP25G	MELSECNET/10 remote I/O controller, GI-50/125 fiber optic	✓	—
	AJ72QBR15	MELSECNET/10 remote I/O controller, coaxial	✓	—
Ethernet interface modules	AJ71QE71	TCP/IP & UDP/IP protocol support, 10BASE2/10BASE5	✓	—
	AJ71QE71-B5	TCP/IP & UDP/IP protocol support, 10BASE5	✓	—
CC-Link module	AJ61QBT11	CC-link master/local	✓	—
Programming module	Q6PU	Portable programming tool	✓	—
Modem interface module	Q6TEL	Modem interface module	✓	—
SRAM IC card	Q1MEM-64S	SRAM 64k bytes (PCMCIA 2.0)	✓	—
	Q1MEM-128S	SRAM 128k bytes (PCMCIA 2.0)	✓	—
	Q1MEM-256S	SRAM 256k bytes (PCMCIA 2.0)	✓	—
	Q1MEM-512S	SRAM 512k bytes (PCMCIA 2.0)	✓	—
	Q1MEM-1MS	SRAM 1M bytes (PCMCIA 2.0)	✓	—
	Q1MEM-2MS	SRAM 2M bytes (PCMCIA 2.0)	✓	—
SRAM + EEPROM IC card	Q1MEM-64SE	SRAM 32k bytes, EEPROM 32k bytes (PCMCIA 2.0)	✓	—
	Q1MEM-128SE	SRAM 64k bytes, EEPROM 64k bytes (PCMCIA 2.0)	✓	—
	Q1MEM-256SE	SRAM 128k bytes, EEPROM 128k bytes (PCMCIA 2.0)	✓	—
	Q1MEM-512SE	SRAM 256k bytes, EEPROM 256k bytes (PCMCIA 2.0)	✓	—
	Q1MEM-1MSE	SRAM 512k bytes, EEPROM 512k bytes (PCMCIA 2.0)	✓	—
SRAM + Flash ROM IC card	Q1MEM-256SF	SRAM 128k bytes, Flash ROM 128k bytes (PCMCIA 2.0)	✓	—
	Q1MEM-512SF	SRAM 256k bytes, Flash ROM 256k bytes (PCMCIA 2.0)	✓	—
	Q1MEM-1MSF	SRAM 512k bytes, Flash ROM 512k bytes (PCMCIA 2.0)	✓	—
	Q1MEM-2MSF	SRAM 1M bytes, Flash ROM 1M bytes (PCMCIA 2.0)	✓	—
Q4AR CPU modules	Q4ARCPU	Program capacity 128k steps, 4096 I/O points	✓	—
Power supply	A61RP	AC100-120/200-240V I/P, DC 5V 8A O/P	✓	—
	A67RP	DC110-125V I/P, DC 5V 8A O/P	✓	—
CPU base unit	A32RB	2 I/O, CPU and power supply slots for each side	✓	—
	A33RB	3 I/O, CPU and power supply slots for each side	✓	—
	A37RHB	7 I/O, CPU and 2 power supply slots for single CPU system	✓	—
Extension base units	A68RB	8 I/O and 2 power supply slots	✓	—
System fault detection	AS92R	System fault detection module	✓	—
Bus switch module	A6RAF	Bus switch module	✓	—
A Series				
ACPU modules	A4UCPU	Program capacity 120k steps, 4096 I/O points	—	✓
	A3UCPU	Program capacity 60k steps, 2048 I/O points	—	✓
	A2UCPU-S1	Program capacity 14k steps, 1024 I/O points	—	✓
	A2UCPU	Program capacity 14k steps, 512 I/O points	—	✓
	A3ACPU	Program capacity 60k steps, 2048 I/O points	—	✓
	A3ACPUP21	Fiber Optic data link (master/local), 2048 I/O points	—	✓
	A3ACPUR21	Coaxial data link (master/local), 2048 I/O points	—	✓
	A2ACPU-S1	Program capacity 14k steps, 1024 I/O points	—	✓
	A2ACPUP21-S1	Fiber optic data link (master/local), 1024 I/O points	—	✓
	A2ACPUR21-S1	Coaxial data link (master/local), 1024 I/O points	—	✓

Product Listing

Type	Model	Specifications	QnACPU	ACPU
			Compatibility	
ACPU modules	A2ACPU	Program capacity 14k steps, 512 I/O points	—	✓
	A2ACPUP21	Fiber optic data link (master/local), 512 I/O points	—	✓
	A2ACPUR21	Coaxial data link (master/local), 512 I/O points	—	✓
	A3NCPU	Program capacity 60k steps, 2048 I/O points	—	✓
	A3NCPUP21	Fiber optic data link (master/local), 2048 I/O points	—	✓
	A3NCPUR21	Coaxial data link (master/local), 2048 I/O points	—	✓
	A2NCPU-S1	Program capacity 14k steps, 1024 I/O points	—	✓
	A2NCPUP21-S1	Fiber optic data link (master/local), 1024 I/O points	—	✓
	A2NCPUR21-S1	Coaxial data link (master/local), 1024 I/O points	—	✓
	A2NCPU	Program capacity 14k steps, 512 I/O points	—	✓
	A2NCPUP21	Fiber optic data link (master/local), 512 I/O points	—	✓
	A2NCPUR21	Coaxial data link (master/local), 512 I/O points	—	✓
	A1NCPU	Program capacity 6k steps, 256 I/O points, built-in power supply	—	✓
A1NCPUP21	Fiber optic data link (master/local), 256 I/O points, built-in power supply	—	✓	
A1NCPUR21	Coaxial data link (master/local), 256 I/O points, built-in power supply	—	✓	
Main base	A32B-E	2 I/O, CPU & power supply slots	✓	✓
	A35B-E	5 I/O, CPU & power supply slots	✓	✓
	A38B-E	8 I/O, CPU & power supply slots	✓	✓
Extension base units	A62B	2 I/O & power supply slots	✓	✓
	A65B	5 I/O & power supply slots	✓	✓
	A68B	8 I/O & power supply slots	✓	✓
	A52B	2 I/O slots	✓	✓
	A55B	5 I/O slots	✓	✓
	A58B	8 I/O slots	✓	✓
Memory modules	A3NMCA-0	No memory, use 4k Ram IC's	—	✓
	A3NMCA-2	16k byte memory	—	✓
	A3NMCA-4	32k byte memory	—	✓
	A3NMCA-8	64k byte memory	—	✓
	A3NMCA-16	128k byte memory	—	✓
	A3NMCA-24	192k byte memory	—	✓
	A3NMCA-40	320k byte memory	—	✓
	A3NMCA-56	448k byte memory	—	✓
	A3AMCA-96	768k byte memory	—	✓
	A4UMCA-128	1024k byte memory (program area 30k x 4)	—	✓
	A4UMCA-8E	64k byte E ² PROM memory (program area 30k)	—	✓
	A4UMCA-32E	256k byte E ² PROM memory (program area 30k)	—	✓
A4UMCA-128E	1024k byte E ² PROM memory (program area 30k x 4)	—	✓	
IC-RAM memory	4KRAM	4k step memory (A1N, A3NMCA-0)	—	✓
EP-ROM memory	4KROM	4k step memory (A1N, A3NMCA-0)	—	✓
	8KROM	8k step memory	—	✓
E ² PROM memory	16KROM	16k step memory	—	✓
	4KEROM	4k step memory (A1N only)	—	✓
EP-ROM memory	16KHROM	16k step memory (AD57, AD57S1, AD57S2, AD58)	—	✓
	64KWROM	128k byte memory (AD51H)	—	✓
	128KWROM	256k byte memory (AD51H)	—	✓
	256KWROM	512k byte memory (AD51H)	—	✓
Power Supply Units & Extension Cables				
Power supply units	A61P	AC 110/220V I/P, DC 5V 8A O/P	✓	✓
	A62P	AC 110/220V I/P, DC 5V 5A & 24V 0.8A O/P	✓	✓
	A63P	DC 24V I/P, DC 5V 8A O/P	✓	✓
	A65P	AC 110/220V I/P, DC 5V 2A & 24V 0.8A O/P	✓	✓
	A67P	DC V I/P DC5V 0.8A O/P	✓	✓
	A61PEU	AC 110/220V I/P DC 5V 8A O/P, LVD compliant	✓	✓
	A62PEU	AC 110/220V I/P; DC 5V 5A & 24V 0.8A O/P, LVD compliant	✓	✓
A66P	AC 110/220V I/P, DC 24V 1.2A O/P	✓	✓	
Extension cables	AC06B	600mm (23.62 inch) cable	✓	✓
	AC12B	1200mm (47.24 inch) cable	✓	✓
	AC30B	3000mm (118.11 inch) cable	✓	✓
I/O Modules and Analog Modules				
AC input modules	AX10	16 points, AC 100V	✓	✓
	AX11	32 points, AC 100V	✓	✓
	AX20	16 points, AC 200V	✓	✓
	AX21	32 points, AC 200V	✓	✓

Product Listing

Type	Model	Specifications	OnACPU	ACPU
			Compatibility	
AC/DC input modules	AX31	32 points, AC 24V or DC 24V	✓	✓
DC input modules	AX31-S1	32 points, DC24V	✓	✓
	AX40	16 points, DC12V or 24V	✓	✓
	AX41	32 points, DC12V or 24V	✓	✓
	AX41-S1	32 points, DC12V or 24V	✓	✓
	AX42	64 points, DC12V or 24V	✓	✓
	AX42-S1	64 points, DC12V or 24V	✓	✓
	AX70	16 points, DC5V or 12V or 24V	✓	✓
	AX71	32 points, DC5V or 12V or 24V	✓	✓
	AX80	16 points, DC12V or 24V	✓	✓
	AX80E	16 points, DC12V or 24V(selectable speed)	✓	✓
	AX81	32 points, DC12V or 24V	✓	✓
	AX81B	32 points, DC12V or 24V, wire breakage detection	✓	✓
	AX81-S1	32 points, DC12V or 24V	✓	✓
	AX81-S2	32 points, DC48V or 60V	✓	✓
	AX82	64 points, DC12V or 24V	✓	✓
	AX50-S1	16 points DC48V	✓	✓
	AX60-S1	16 points DC100V or 110V or 125V	✓	✓
	AX11EU	16 points AC100-120V, LVD compliant	✓	✓
AX21EU	16 points AC200-240V, LVD compliant	✓	✓	
Relay output modules	AY10	16 points, AC240V or 24V or 2A	✓	✓
	AY10A	16 points, AC240V or 24V or 2A (independent commons)	✓	✓
	AY11	16 points, AC240V or 24V or 2A	✓	✓
	AY11A	16 points, AC240V or 24V or 2A (independent commons)	✓	✓
	AY11AEU	16 points, AC240V or 24V or 2A (independent commons)	✓	✓
	AY11E	16 points, AC 240V or 24V, 2A (fused commons)	✓	✓
	AY11EEU	16 points, AC 240V or 24V, 2A (fused commons)	✓	✓
	AY13	32 points, AC240V or 24V or 2A	✓	✓
	AY13E	32 points, AC240V or 24V or 2A (fused commons)	✓	✓
	AY13EU	32 points, AC240V or 24V or 2A (fused commons)	✓	✓
Triac/SSR output module	AY15EU	24 points, AC240V or 24V or 2A, LVD compliant	✓	✓
	AY20EU	16 points, AC240V, 1A, LVD compliant	✓	✓
	AY22	16 points, AC240V, 2A	✓	✓
Transistor output modules	AY23	32 points, AC240V, 0.6A	✓	✓
	AY40	16 points, DC12V or 24V, 0.1A	✓	✓
	AY40A	16 points, DC12V or 24V, 0.3A	✓	✓
	AY40P	16 points, DC12V or 24V, 0.1A (short cct. protection)	✓	✓
	AY41	32 points, DC12V or 24V, 0.1A	✓	✓
	AY41P	32 points, DC12V or 24V, 0.1A (short cct. protection)	✓	✓
	AY42	64 points, DC12V or 24V, 0.1A	✓	✓
	AY42-S4	64 points, DC12V or 24V, 0.1A (high speed)	✓	✓
	AY50	16 points, DC12V or 24V, 0.5A	✓	✓
	AY51	32 points, DC12V or 24V, 0.5A	✓	✓
	AY51-S1	32 points, DC12V or 24V, 0.3A	✓	✓
	AY60	16 points, DC12V or 24V or 48V, 2A	✓	✓
	AY60E	16 points, DC12V or 24V or 48V, 2A/0.8A	✓	✓
	AY60EP	16 points, DC12V or 24V, 2A/0.8A	✓	✓
	AY60S	16 points, DC24V or 48V, 2A/0.8A	✓	✓
	AY70	16 points, DC5V or 12V, 16mA	✓	✓
	AY71	32 points, DC5V or 12V, 16mA	✓	✓
	AY72	64 points, DC5V or 12V, 16mA	✓	✓
	AY80	16 points, DC12V or 24V, 0.5A	✓	✓
	AY80EP	16 points, DC12V or 24V, 0.8A (short cct. protection)	✓	✓
AY81	32 points, DC12V or 24V, 0.5A	✓	✓	
AY81EP	32 points, DC12V or 24V, 0.8A (short cct. protection)	✓	✓	
AY82EP	64 points, DC12V or 24V, 0.1A (short cct. protection)	✓	✓	
Input/output module	A42XY	64 I/P points, 64 O/P points, DC 12V or 24V	✓	✓
Blanking module	AG60	Vacant I/O slot blanking module	✓	✓
Dummy module	AG62	16, 32, 48 or 64 point dummy module	✓	✓
Interrupt module	AI61	16 points, DC 12V or 24V	✓	✓
A/D conversion modules	A68AD	4-20mA or 0 to ±10V I/P, 8 channels, analog input	✓	✓
	A68AD-S2	Same as A68AD, but A/D change can be set for each channel	✓	✓
	A68ADN	0-20mA or 0 to ±10V I/P, 8 channels (high resolution)	✓	✓

Product Listing

Type	Model	Specifications	QnACPU Compatibility	ACPU
A/D conversion modules	A616AD	0-20mA or 0 to $\pm 10V$ I/P, 16 channels	✓	✓
	A60MX	Analog I/P multiplex unit	✓	✓
	A60MXR	Analog I/P multiplex unit (isolated channels)	✓	✓
	A60MXT	Thermocouple I/P multiplex unit	✓	✓
	A616TD	Thermocouple I/P, 16 channels	✓	✓
	AC12MX	1.2m (3.94 ft) cable for A60MX series multiplexer	✓	✓
	A68RD3	3-wire Pt100 I/P, 8 channels	✓	✓
D/A conversion modules	A68RD4	4-wire Pt100 I/P, 8 channels	✓	✓
	A68DAV	0 to $\pm 10V$ O/P, 8 channels (high resolution)	✓	✓
	A68DAI-S1	0- $\pm 20mA$ O/P, 8 channels	✓	✓
	A62DA	4-20mA or 0 to $\pm 10V$ O/P, 2 channels, analog output	✓	✓
	A62DA-S1	4-20mA or 0-20mA or 0 to $\pm 10V$ O/P, 2 channels, analog output	✓	✓
	A616DAV	-10 to +10V or -5 to +5V O/P, 16 channels	✓	✓
	A616DAI	0-20mA O/P, 16 channels	✓	✓
High speed counter modules	A68P	I/P slot power supply for A616DAV/I, DC $\pm 15V$ O/P	✓	✓
	AD61	24 bit binary count, 1 or 2 phase, 2 channels, 50k pps	✓	✓
Positioning modules	AD61-S1	24 bit binary count, 1 or 2 phase, 2 channels, 7/10k pps	✓	✓
	AD75M1	SSC net, 1 axis	✓	✓
	AD75M2	SSC net, 2 axes	✓	✓
	AD75M3	SSC net, 3 axes	✓	✓
	AD75P1-S3	Pulse train and line driver O/P, 1 axis	✓	✓
	AD75P2-S3	Pulse train and line driver O/P, 2 axes	✓	✓
	AD75P3-S3	Pulse train and line driver O/P, 3 axes	✓	✓
	AD778M	Connects with server by SSC-NET, 8 axes	✓	✓
	AD70	Analog voltage O/P, 1 axis	✓	✓
	AD70D	Digital voltage O/P, 1 axis	✓	✓
	AD71	Pulse train O/P, 2 axes	✓	✓
	AD71-S1	Pulse train O/P, 2 axes	✓	✓
	AD71-S2	Pulse train O/P, 2 axes	✓	✓
	AD71-S7	Pulse train O/P, 2 axes	✓	✓
Positioning training modules	AD72	Analog voltage O/P, 2 axes	✓	✓
	AD75TU	Teaching unit for AD75	✓	✓
Positioning Detection Unit	AD71TU	Teaching unit for AD71/72	✓	✓
	A61LS	Resolve input, one rotation for 1/4096-16 channel ON/OFF settings	✓	✓
Ultrasonic linear scale interface unit	A62LS-S5	Max. no. of divisions: 131,072, 8 channel positioning signal output	✓	✓
	A63LS	2 control channels possible for one unit	✓	✓
Intelligent communication modules	A64BTL	Measures from 0.000 to 3,550,000mm at units of .025mm	✓	✓
	AD51-S3	GPC Basic, 8 tasks, standard 66k bytes memory	✓	✓
External error check modules	AD51H-S3	AD51H-BASIC, 8 tasks, IC memory card I/F	✓	✓
	AD51FD-S3	Able to check 6 bytes of external errors	✓	✓
External display unit	A6FD	16 character, character height 17mm, 160 character types, LED display	✓	✓
	A6DU-B	Data access unit	✓	✓
Printer module	AD59	Parallel I/F and memory card I/F	✓	✓
	AD59-S1	Memory card interface (ext. attached), parallel interface (Cyntronics compatible)	✓	✓
Voice output module	A11VC	60 channels, mic input, 64sec. recording time	✓	✓
Mic for voice output unit	A11VC-MIC	Exclusive use	✓	✓
System monitor module	AS91	5 O/P points, AC 240V or DC24V, 2A	✓	✓
Computer link module	AJ71UC24	RS232C & RS422 I/F	✓	✓
MELSECNET				
MELSECNET II modules	AJ71C22S1	RS422	✓	✓
	AJ71C23-S3	RS422	✓	✓
	AJ71AP21	MELSECNET II master/local, S1-200/250 fiber optic	✓	✓
	AJ71AP21-S3	MELSECNET II master/local, G1-50/125 fiber optic	✓	✓
	AJ71AP21GE	MELSECNET II master/local, G1-62.5/125 fiber optic	✓	✓
	AJ71AR21	MELSECNET II master/local, coaxial	✓	✓
	AJ72P25	MELSECNET II remote I/O controller, fiber optic	✓	✓
MELSECNET/B modules	AJ72R25	MELSECNET II remote I/O controller, coaxial	✓	✓
	AJ71AT21B	MELSECNET/B master/local	✓	✓
MELSECNET/10 modules	AJ72T25B	MELSECNET/B remote I/O	✓	✓
	AJ71LP21	MELSECNET/10 master/local, S1-200/250 fiber optic	—	✓
	AJ71LP21G	MELSECNET/10 master/local, G1-50/125 Type fiber optic	—	✓
	AJ71LP21GE	MELSECNET/10 master/local G1-62.5/125 Type fiber optic	—	✓

Product Listing

Type	Model	Specifications	QnACPU	ACPU
			Compatibility	
MELSECNET/10 modules	AJ71BR11	MELSECNET/10 master/local, coaxial	—	✓
	AJ71LR21	MELSECNET/10 master/local, coaxial	—	—
	AJ72LP25	MELSECNET/10 remote I/O controller, fiber optic	—	—
	AJ72LP25G	MELSECNET/10 remote I/O controller, fiber optic GI	—	—
	AJ72LP25GE	MELSECNET/10 remote I/O controller, fiber optic	—	—
	AJ72BR15	MELSECNET/10 remote I/O controller, coaxial	—	—
	AJ72LR25	MELSECNET/10 remote I/O controller, coaxial	—	—
MELSECNET/10 repeater	A6BR10	MELSECNET/10 coaxial cable repeater	✓	✓
MELSECNET/10 repeater	A6BR10-DC	MELSECNET/10 coaxial cable repeater, DC24V power supply	✓	✓
MELSECNET/10 resistance	A6RCON-R75	75Ω	✓	✓
Coaxial type MELSECNETII	A6BSW-R	Coaxial type	✓	✓
Ethernet interface module	AJ71E71-S3	TCP/IP & UDP/IP protocol support	✓	✓
MELSECNET/MINI-S3				
Master modules	AJ71PT32-S3	MELSECNET/MINI-S3 master module	✓	✓
	AJ71T32-S3	Twisted pair master unit	✓	✓
Slave station	AJ72PT35	Optic/twisted pair slave station, for use with building block type input/output unit	✓	✓
	AJ72T35	Twisted pair slave station, for use with building block type input/output unit	✓	✓
External Remote I/O for Optic Data Link				
Input unit	AJ35PJ-8D	8 points DC 12/24V (4/10mA)	✓	✓
External Remote I/O for Twisted Pair Data Link				
Input unit	AJ35TJ-8D	8 points DC 12/24V (4/10mA)	✓	✓
Output units	AJ35TJ-8R	8 points AC 240V (2A), relay output	✓	✓
	AJ35TJ-8T2	8 points DC 12/24V (0.5A), transistor output	✓	✓
External Remote I/O for Optic and Twisted Pair Data Links				
Input units	AJ35PTF-32A	AC input 32 points	Input Units A: AC 100V 10mA Photocoupler insulation D: DC 12/24V 3/7mA Photocoupler insulation Output R: Relay output AC240V/DC24V 2A T: Transistor output DC12/24V 0.5A Photocoupler Insulation S: Triac Output AC100/200V 0.6A Photocoupler Insulation	✓
	AJ35PTF-32D	DC input 32 points		✓
Output units	AJ35PTF-24R	Relay output 24 points		✓
	AJ35PTF-24S	Triac output 24 points		✓
	AJ35PTF-24T	Transistor output 24 points		✓
	AJ35PTF-28AR	Input 16 points, Output 12 points: Total 28 points		✓
AJ35PTF-28AS	✓			
AJ35PTF-28DR	✓			
AJ35PTF-28DS	✓			
Input/Output units	AJ35PTF-28DT	Input 32 points, Output 24 points: Total 56 points		✓
	AJ35PTF-56AR			✓
	AJ35PTF-56AS			✓
	AJ35PTF-56DR			✓
	AJ35PTF-56DS			✓
	AJ35PTF-56DT		✓	
Dynamic scan unit	AJ35PTF-128DT	Input 64 points, Output 64 points	✓	
External Remote I/O Twisted Pair Data Link				
Remote I/O terminal units	AJ35TB1-16A	16 points I/P AC100V	✓	
	AJ35TB1-16D	16 points I/P DC24V	✓	
	AJ35TB2-16D	16 points I/P DC24V, 2-wire type terminal	✓	
	AJ35TB3-8D	8 points I/P DC24V, 3-wire type terminal	✓	
	AJ35TB1-16R	16 points relay O/P AC240V/DC24V 2A	✓	
	AJ35TB1-16T	16 points transistor O/P DC24V 0.1A	✓	
	AJ35TB1A-8R	8 points relay O/P	✓	
	AJ35TB1A-8T	8 points transistor O/P	✓	
	AJ35TB2-16T	16 points transistor O/P DC24V 0.1A, 2-wire type terminal	✓	
	AJ35TB2-8R	8 points relay O/P DC24V 0.1A, 2-wire type terminal	✓	
	AJ35TB2-8T	8 points transistor O/P DC24V 0.1A, 2-wire type terminal	✓	
	AJ35TB1-16AR	8 points I/P AC 100V, 8 points relay, O/P AC240V/DC24V 2A	✓	
	AJ35TB1-16DR	8 points I/P DC 24V, 8 points relay, O/P AC240V/DC24V 2A	✓	
	AJ35TB1-16DT	8 points I/P DC 24V, 8 points transistor, O/P DC24V 0.1A	✓	
	Remote I/O connector units	AJ35TC1-32D	32 points I/P DC24V	✓
		AJ35TC1-32T	32 points transistor O/P DC24V 0.1A	✓
AJ35TC1-32DT		16 points I/P DC24V, 16 points transistor, O/P DC24V 0.1A	✓	
Bypass Unit	AJ35TT-BU	Twisted pair/twisted pair bypass unit	✓	
	AJ35TP-BU	Twisted pair/fiber optic bypass unit	✓	
Converters	AJ35PTC-CNV	Twisted pair/plastic fiber optic converter	✓	
	AJ35PTC-CNV-SI	Twisted pair/SI fiber optic converter	✓	

Product Listing

Type	Model	Specifications	QnACPU	ACPU
			Compatibility	
Converters	AJ35PTC-CNV-GI	Twisted pair/GI fiber optic converter	✓	✓
	AJ35PP-CNV	Plastic fiber optic/plastic fiber optic converter	✓	✓
	AJ35PP-CNV-SI	Plastic fiber optic/SI fiber optic converter	✓	✓
Others for MELSECNET/mini-S3	AJ35PTF-R2	RS232C interface	✓	✓
	AJ35PT-OPB-M1-S3	Mount type	✓	✓
	AJ35PT-OPB-P1-S3	Portable	✓	✓
	AJ35T-JB-S3	Relay type	✓	✓
	AJ35T-JBR-S3	Repeater type	✓	✓
	AC30 MINI	For use between joint box and AJ35T-OPB-P1-S3	✓	✓
MELSEC I/O Link				
I/O LINK master	AJ51T64	I/O LINK master module, 64 remote I/O control	✓	✓
DC input units	AJ55TB3-4D	4 points, DC24V	✓	✓
DC input units	AJ55TB3-8D	8 points, DC24V	✓	✓
	AJ55TB3-16D	16 points, DC24V	✓	✓
Transistor output units	AJ55TB2-4T	4 points, transistor output (sink), DC24V 0.5A/Pt	✓	✓
	AJ55TB2-8T	8 points, transistor output (sink), DC24V 0.5A/Pt	✓	✓
	AJ55TB2-16T	16 points, transistor output (sink), DC24V 0.5A/Pt	✓	✓
Relay output units	AJ55TB2-4R	4 points, relay output, AC240V 2A/Pt	✓	✓
	AJ55TB2-8R	8 points, relay output, AC240V 2A/Pt	✓	✓
	AJ55TB2-16R	16 points, relay output, AC240V 2A/Pt	✓	✓
DC input/transistor output units	AJ55TB32-4DT	2 points, DC24V input / 2 points, transistor output (sink), DC24V 0.5A/Pt	✓	✓
	AJ55TB32-8DT	4 points, DC24V input / 4 points, transistor output (sink), DC24V 0.5A/Pt	✓	✓
	AJ55TB32-16DT	8 points, DC24V input / 8 points, transistor output (sink), DC24V 0.5A/Pt	✓	✓
DC input/relay output units	AJ55TB32-4DR	2 points, DC24V input / 2 points, relay output, DC240V 2A/Pt	✓	✓
	AJ55TB32-8DR	4 points, DC24V input / 4 points, relay output, DC240V 2A/Pt	✓	✓
	AJ55TB32-16DR	8 points, DC24V input / 8 points, relay output, DC240V 2A/Pt	✓	✓
CC-Link				
Master/Local	AJ61BT11	CC-Link master/local module	—	✓
	AJ61QBT11	QnA master/local module	✓	—
Compact remote I/O				
Compact input unit	AJ65SBTB1-8D	8 points DC24V (7mA) (sink/source type) 1-wire, 1.5msec response time, terminal type	✓	✓
	AJ65SBTB1-16D	16 points DC24V (7mA) (sink/source type) 1-wire, 1.5msec response time, terminal type	✓	✓
	AJ65SBTB1-16D1	16 points DC24V (5mA) (sink/source type) 1-wire, 0.2msec response time, terminal type	✓	✓
	AJ65SBTB1-32D	32 points DC24V (7mA) (sink/source type) 1-wire, 1.5msec response time, terminal type	✓	✓
	AJ65SBTB1-32D1	32 points DC24V (5mA) (sink/source type) 1-wire, 0.2msec response time, terminal type	✓	✓
	AJ65SBTBTC1-32D	32 points DC24V (5mA) (sink/source type) 1-wire, 1.5msec response time, one touch connector type (plug sold separately)	✓	✓
	AJ65SBTBTC1-32D1	32 points DC24V (5mA) (sink/source type) 1-wire, 0.2msec response time, one touch connector type (plug sold separately)	✓	✓
	AJ65SBTC4-16D	16 points DC24V (5mA) 2, 3, 4-wire, 1.5msec response time, one touch connector type (8 sensor use) (sink / source switch) (plug sold separately)	✓	✓
	AJ65SBTW4-16D	16 points DC24V (5mA), 1.5msec response time, waterproof 4-wire (8 sensor use) (sink / source switch) (cap sold separately)	✓	✓
	AJ65SBTCF1-32D	32 points DC24V (5mA) (sink/source type) 1-wire, 1.5msec response time, FCN connector type (40 pin connector)	✓	✓
	AJ65SBTB3-8D	8 points DC24V (7mA) (sink/source type) 3-wire, 1.5msec response time, terminal type	✓	✓
	AJ65SBTB3-16D	16 points DC24V (7mA) (sink/source type) 3-wire, 1.5msec response time, terminal type	✓	✓
	AJ65SBTB2-8A	8 points AC100-120V (7mA) 1-wire 20msec response time, terminal type	✓	✓
	AJ65SBTB2-16A	16 points AC100-120V (7mA) 1-wire 20msec response time, terminal type	✓	✓
	AJ65SBTB2N-8A	8 points AC100-120V (7mA) 2-wire 20msec response time, terminal type	✓	✓
	AJ65SBTB2N-16A	16 points AC100-120V (7mA) 2-wire 20msec response time, terminal type	✓	✓
Compact output units	AJ65SBTB1-8T	8 points DC12/24V (0.5A) transistor output (sink type) 1-wire, terminal type	✓	✓
	AJ65SBTB1-16T	16 points DC12/24V (0.5A) transistor output (sink type) 1-wire, terminal type	✓	✓
	AJ65SBTB1-32T	32 points DC12/24V (0.5A) transistor output (sink type) 1-wire, terminal type	✓	✓
	AJ65SBTC1-32T	32 points DC12/24V (0.1A) transistor output (sink type) 1-wire, one touch connector type (plug for connector sold separately)	✓	✓
	AJ65SBTB1-16T1	16 points DC12/24V (0.5A) transistor output (sink type) 1-wire terminal type (low current flow when off)	✓	✓
	AJ65SBTB1-32T1	32 points DC12/24V (0.5A) transistor output (sink type) 1-wire terminal type (low current flow when off)	✓	✓
	AJ65SBTCF1-32T	32 points DC12/24V (0.1A) transistor output (sink type) 1-wire, FCN connector (40 pin connector)	✓	✓
	AJ65SBTB2-8T	8 points DC12/24V (0.5A) transistor output (sink type) 2-wire, terminal type	✓	✓
	AJ65SBTB2-16T	16 points DC12/24V (0.5A) transistor output (sink type) 2-wire, terminal type	✓	✓
	AJ65SBTB1-8TE	8 points DC12/24V (0.1A) transistor output (source type) 1-wire, terminal type	✓	✓
AJ65SBTB1-16TE	16 points DC12/24V (0.1A) transistor output (source type) 1-wire, terminal type	✓	✓	

Product Listing

Type	Model	Specifications	OnACPU	ACPU
			Compatibility	
Compact output units	AJ65SBTB2-8R	8 points DC24V/AC240V (2A) relay output, 1-wire, terminal type	✓	✓
	AJ65SBTB2-16R	16 points DC24V/AC240V (2A) relay output, 1-wire, terminal type	✓	✓
	AJ65SBTB2N-8R	8 points DC24V/AC240V (2A) relay output, 2-wire, terminal type	✓	✓
	AJ65SBTB2N-16R	16 points DC24V/AC240V (2A) relay output, 2-wire, terminal type	✓	✓
	AJ65SBTB2-8S	8 points AC100-240V (0.6A) triac output, 1-wire, terminal type	✓	✓
	AJ65SBTB2-16S	16 points AC100-240V (0.6A) triac output, 1-wire, terminal type	✓	✓
	AJ65SBTB2N-8S	8 points AC100-240V (0.6A) triac output, 2-wire, terminal type	✓	✓
Compact input/ output units	AJ65SBTC1-32DT	16 input points DC24V (5mA) (sink type) 1-wire 1.5msec response type; 16 output points DC24V(0.1A) transistor output (sink type) 1-wire, one touch connector type (plug sold separately)	✓	✓
	AJ65SBTC1-32DT1	16 input points DC24V (5mA) (sink type) 1-wire 0.2msec response type; 16 output points DC24V(0.1A) transistor output (sink type) 1-wire, one touch connector type (plug sold separately)	✓	✓
	AJ65SBTC4-16DT	8 input points DC24V (5mA) (sink type) 2, 3, 4-wire, 1.5msec response type (8 sensor use); 8 output points DC24V(0.5A) transistor output (sink type) 2, 3, 4-wire, one touch connector type (plug sold separately)	✓	✓
	AJ65SBTW4-16DT	8 input points DC24V (5mA) (sink type) 1.5msec response type, waterproof 4-wire (8 sensor use); 8 output points DC24V(0.5A) transistor output (sink type) 1-wire, (cap sold separately) (waterproof type)	✓	✓
	AJ65SBTB1-16DT	8 input points DC24V (7mA) (sink type) 1-wire, 1.5msec response time; 8 output points DC24V (0.5A) transistor output (sink type) 1-wire, terminal type	✓	✓
	AJ65SBTB1-16DT1	8 input points DC24V (5mA) (sink type) 1-wire, 0.2msec response time; 8 output points DC24V (0.5A) transistor output (sink type) 1-wire, terminal type	✓	✓
	AJ65SBTB1-32DT	16 input points DC24V (7mA) (sink type) 1-wire, 1.5msec response time; 16 output points DC24V (0.5A) transistor output (sink type) 1-wire, terminal type	✓	✓
	AJ65SBTB1-32DT1	16 input points DC24V (5mA) (sink type) 1-wire, 0.2msec response time; 16 output points DC24V (0.5A) transistor output (sink type) 1-wire, terminal type	✓	✓
	AJ65SBTCF1-32DT	16 input points DC24V (5mA) (sink/source type) 1-wire, 1.5msec response time; 16 output points DC12/24V (0.1A) transistor output (sink type) 1-wire, FCN connector (40 pin connector)	✓	✓
	AJ65SBTB32-8DT	4 input points DC24VC (7mA) (sink type) 3-wire, 1.5msec response time; 4 output points DC24V (0.5A) transistor output (sink type) 2-wire, terminal type	✓	✓
	AJ65SBTB32-16DT	8 input points DC24V (7mA) (sink type) 3-wire, 1.5msec response time; 8 output points DC24V (0.5A) transistor output (sink type) 2-wire, terminal type	✓	✓
Remote digital input	AJ65BTB1-16D	16 points, DC24V	✓	✓
	AJ65BTB2-16D	16 points, DC24V	✓	✓
	AJ65BTC1-32D	32 points, DC24V	✓	✓
Remote digital output	AJ65BTB1-16T	16 points, transistor, DC24V/0.5A, Sink	✓	✓
	AJ65BTB2-16T	16 points, transistor, DC24V/0.5A	✓	✓
	AJ65BTC1-32T	32 points, transistor, DC24V/0.1A	✓	✓
	AJ65BTB2-16R	16 points, relay, AC240V/2A	✓	✓
Remote digital I/O	AJ65BTB1-16DT	8 points I/P DC24V, 8 points O/P Tr., DC24V/0.5A	✓	✓
	AJ65BTB2-16DT	8 points I/P DC24V, 8 points O/P Tr., DC24V/0.5A	✓	✓
	AJ65BTB2-16DR	8 points I/P DC24V, 8 points relay, AC240V/2A	✓	✓
Analog input	AJ65BT-64AD	4 channel, 0 to ±10V or 4 to 20mA	✓	✓
	AJ65BT-64DAV	4 channel, 0 to ±10V	✓	✓
	AJ65BT-64DAI	4 channel, 4 to 20mA	✓	✓
	AJ65SBT-64AD	4 channel	✓	✓
	AJ65SBT-62DA	2 channel	✓	✓
High speed counter	AJ65BT-D62	2 channel, 200k pps, 2 output / channel output	✓	✓
	AJ65BT-D62D	2 channel, 400k pps differential input, 2 output / channel output	✓	✓
	AJ65BT-D62D-S1	2 channel, 400k pps differential input and preset, 2 output / channel output	✓	✓
Temperature input	AJ65BT-64RD3	4 channel, Pt 100, 3-wire	✓	✓
	AJ65BT-64RD4	4 channel, Pt 100, 4-wire	✓	✓
	AJ65BT-68TD	8 channel, thermocouple, B, R, S, K, E, J, T	✓	✓
	AJ65BT-68RD3	8 channel, Pt 100 3-wire	✓	✓
	AJ65BT-68RD4	8 channel, Pt 100 4-wire	✓	✓
Positioning Control	AJ65BT-D32I-D2	2 channel R/W	✓	✓
	AJ65BT-D75P2	Pulse train output, 2 axes	✓	✓
RS232C	AJ65BT-R2	RS232C 1 channel	✓	✓
Programming I/F	AJ65BT-G4	RS422 1 channel for programming terminal connection	✓	✓
PC interface board 2	A80BDE-J61BT11	CC-Link interface board for DOS/V PC (master/local modules for PCI bus slot)	✓	✓
	A80BDE-J61BT13	CC-Link interface board for DOS/V PC (local module for PCI bus slot)	✓	✓

Product Listing

Type	Model	Specifications	QnACPU	ACPU
			Compatibility	
Repeater Units				
CC-Link optic repeater unit	AJ65SBT-RPS	SI/QSI type for use with fiber optic cable (2 units can be used together), for 156k/625k/2.5M/5M/10Mbps, maximum transmission distance: 500m(SI), 1000m(QSI), maximum number of connection steps: 2	✓	✓
	AJ65SBT-RPG	GI type for use with fiber optic cable (2 units can be used together), for 156k/625k/2.5M/5M/10Mbps, maximum transmission distance: 2000m, maximum number of connection steps: 2	✓	✓
CC-Link spatial optic repeater unit	AJ65BT-RPI-10A	AJ65BT-RPI-10A and AJ65BT-RPI-10B are used as a set. For 156k/625k/2.5Mbps, 0-100m infrared transmission range, optic transmission monitoring function	✓	✓
CC-Link spatial optic repeater unit	AJ65BT-RPI-10B	AJ65BT-RPI-10A and AJ65BT-RPI-10B are used as a set. For 156k/625k/2.5Mbps, 0-100m infrared transmission range, optic transmission monitoring function	✓	✓
CC-Link repeater (T-branch) unit	AJ65SBT-RPT	For 156k/625k/2.5M/5M/10Mbps, maximum number of connection steps: 10, T branch wiring available.	✓	✓
Software Package				
GX Developer (MELSEC Programming software)	SW□D5C-GPPW-E	CD-ROM, English version, sold individually	✓	✓
	SW□D5C-GPPW-EA	CD-ROM, English version, sold individually, n-license product	✓	✓
GX Simulator (MELSEC Simulation software)	SW□D5C-LLT-E	CD-ROM, English version, sold individually	✓	✓
	SW□D5C-LLT-EA	CD-ROM, English version, sold individually, n-license product	✓	✓
GX Works	SW□D5C-GPPLT-E	GX Developer (CD-ROM), GX Simulator (CD-ROM), English version, sold as a set	✓	✓
GX Converter (MELSEC Data conversion software)	SW□D5C-CNWW-E	CD-ROM, English version, sold individually	✓	✓
	SW□D5C-CNWW-EA	CD-ROM, English version, sold individually, n-license product	✓	✓
GX Configurator-AP (AD75/M Positioning unit software)	SW□D5C-AD75P-E	CD-ROM, English version, sold individually	✓	✓
GX Configurator-CC (CC-Link modules software)	SW0D5C-J61P	A series master unit parameter settings, remote modules parameter settings, circuit test, monitoring, etc. (software package for Windows95, Windows98, WindowsNT Workstation4.0)	✓	✓
MX Links (Basic communication support tool)	SW□D5F-CSKP-E	Sold individually (English version)	✓	✓
	SW□D5F-CSKP-E5	5-License product (English version)	✓	✓
	SW□D5F-CSKP-E10	10-License product (English version)	✓	✓
	SW□D5F-CSKP-E20	20-License product (English version)	✓	✓
MX Chart (Excel communication support tool)	SW□D5F-OLEX-E	Sold individually (English version)	✓	✓
	SW□D5F-CSOLEX-E	MX Links, MX Chart, sold as a set (English version)	✓	✓
	SW□D5F-OLEX-E5	5-License product (English version)	✓	✓
	SW□D5F-OLEX-E10	10-License product (English version)	✓	✓
MX Monitor (Monitoring tools)	SW□D5F-XMOP-E	Sold individually (English version)	✓	✓
	SW□D5F-CSXMOP-E	MX Links, MX Monitor, sold as a set (English version)	✓	✓
	SW□D5F-XMOP-E5	5-License product (English version)	✓	✓
	SW□D5F-XMOP-E10	10-License product (English version)	✓	✓
MX Parts	SW□D5C-PIC-B	Collection of graphics data for use with MX Monitor	✓	✓
PC Interface Boards				
MELSECNET/10 PC boards	A70BDE-J71QLP23	MELSECNET/10 local, fiber optic SI/QSI-200/250	✓	✓
	A70BDE-J71QLP23GE	MELSECNET/10, fiber optic GI-62.5/125	✓	✓
	A70BDE-J71QBR13	MELSECNET/10, coaxial cable	✓	✓
	A70BDE-J71QLR23	MELSECNET/10, coaxial cable	✓	✓
MELSECNETII interface board	A70BDE-J71AP23	S5-200/250 cable	✓	✓
PLC CPU board	A80BDE-A2USH-S1	A2USH-S1 CPU type board	✓	✓
CC-Link PC board	A80BDE-J61BT13	Twisted cable, local station	✓	✓
	A80BDE-J61BT11	Twisted cable, master local station	✓	✓

RyansElectric.com



Safety Warning

To ensure proper use of the products listed in this catalog, please be sure to read the instruction manual prior to use.



MITSUBISHI ELECTRIC CORPORATION

HEAD OFFICE: MITSUBISHI DENKI BLDG., 2-2-3, MARUNOUCHI, CHIYODA-KU, TOKYO 100-8310, JAPAN