

FEATURES

- Smallest in its class
- Compact and high-capacity 25 A load switching
- Pin in Paste compatible model added

TYPICAL APPLICATIONS

- Power windows, Auto door lock, Electrically powered mirrors, Power sunroof, Powered seats, Lift gates and Slide door closers, etc. for DC motor forward/reverse control circuits

ORDERING INFORMATION

ACTE

Contact arrangement

2: 1 Form C

3: 1 Form C × 2 (8 terminals type)

Heat resistance/Protective construction

H: High heat-resistant type/Sealed type

R: Pin in Paste type/Flux tight type

Coil resistance

1: 110Ω

2: 160Ω

3: 220Ω

TYPES

Contact arrangement	Nominal coil voltage	Coil resistance	Part No.	
			Heat resistance	
			High heat-resistant type	Pin in Paste type
1 Form C	12V DC	110Ω	ACTE2H1	ACTE2R1
		160Ω	ACTE2H2	ACTE2R2
		220Ω	ACTE2H3	ACTE2R3
1 Form C × 2 (8 terminals type)		110Ω	ACTE3H1	ACTE3R1
		160Ω	ACTE3H2	ACTE3R2
		220Ω	ACTE3H3	ACTE3R3

Standard packing; Carton (tube): 50 pcs.; Case: 2,000 pcs. (1 Form C)
Carton (tube): 40 pcs.; Case: 2,000 pcs. (1 Form C × 2)

TE (ACTE)

RATING

1. Coil data

Nominal coil voltage	Pick-up voltage (at 20°C 68°F)	Drop-out voltage (at 20°C 68°F)	Nominal operating current [±10%] (at 20°C 68°F)	Coil resistance [±10%] (at 20°C 68°F)	Nominal operating power (at 20°C 68°F)	Usable voltage range
12V DC	Max. 5.5V DC (Initial)	Min. 0.6V DC (Initial)	109 mA	110Ω	1,309 mW	10 to 16V DC
	Max. 6.5V DC (Initial)	Min. 0.8V DC (Initial)	75 mA	160Ω	900 mW	
	Max. 7.7V DC (Initial)	Min. 0.8V DC (Initial)	54.5 mA	220Ω	655 mW	

2. Specifications

Characteristics	Item	Specifications	
Contact	Arrangement	1 Form C, 1 Form C × 2	
	Contact resistance (Initial)	N.O.: Typ4mΩ, N.C.: Typ5mΩ (By voltage drop 6V DC 1A)	
	Contact material	Ag alloy (Cadmium free)	
Rating	Nominal switching capacity (resistive load)	N.O.: 20A 14V DC, N.C.: 10A 14V DC	
	Max. carrying current (12V DC initial)*3	25A for 2 minutes (at 20°C 68°F)	
	Nominal operating power		1,309 mW (Pick-up voltage 5.5V DC type)
			900 mW (Pick-up voltage 6.5V DC type)
		655 mW (Pick-up voltage 7.7V DC type)	
	Min. switching capacity (resistive load)*1	1A 14V DC	
Electrical characteristics	Insulation resistance (Initial)	Min. 100 MΩ (at 500V DC, Measurement at same location as "Breakdown voltage" section.)	
	Breakdown voltage (Initial)	Between open contacts	500 Vrms for 1 min. (Detection current: 10mA)
		Between contacts and coil	500 Vrms for 1 min. (Detection current: 10mA)
	Operate time (at nominal voltage)	Max. 10ms (at 20°C 68°F, excluding contact bounce time) (Initial)	
Release time (at nominal voltage)	Max. 10ms (at 20°C 68°F, excluding contact bounce time) (Initial) (without protective element)		
Mechanical characteristics	Shock resistance	Functional	Min. 100 m/s ² {10G} (Half-wave pulse of sine wave: 11ms; detection time: 10μs)
		Destructive	Min. 1,000 m/s ² {100G} (Half-wave pulse of sine wave: 6ms)
	Vibration resistance	Functional	10 Hz to 100 Hz, Min. 44.1 m/s ² {4.5G} (Detection time: 10μs)
		Destructive	10 Hz to 500 Hz, Min. 44.1 m/s ² {4.5G}, Time of vibration for each direction; X, Y direction: 2 hours, Z direction: 4 hours
Expected life	Mechanical	Min. 10 ⁷ (at 120 cpm)	
	Electrical*4	<Resistive load> Min. 10 ⁵ (at nominal switching capacity, operating frequency: 1s ON, 9s OFF)	
<Motor load> Min. 10 ⁵ (25 A 14V DC at motor lock condition), operating frequency: 0.5s ON, 9.5s OFF			
Conditions	Conditions for operation, transport and storage*2	High heat-resistant/Pin in Paste type Ambient temperature: -40°C to +110°C -40°F to +230°F, Humidity: 2% R.H. to 85% R.H. (Not freezing and condensing at low temperature)	
Mass		Single type: approx. 3.5 g .12 oz, Twin type: approx. 6.5 g .23 oz	

Notes:

*1. This value can change due to the switching frequency, environmental conditions, and desired reliability level, therefore it is recommended to check this with the actual load.

*2. The upper operation ambient temperature limit is the maximum temperature that can satisfy the coil temperature rise value. Refer to "6. Usage, Storage and Transport Conditions" in [AMBIENT ENVIRONMENT section in Relay Technical Information](#).

Please inquire if you will be using the relay in a high temperature atmosphere (110°C 230°F).

*3. Depends on connection conditions. Also, this does not guarantee repeated switching. We recommend that you confirm operation under actual conditions.

*4. Do not use for lamp loads, electric discharge lamp loads, any other lamp loads and capacitor loads. Please contact us for details.

* If the relay is used continuously for long periods of time with coils on both sides in an energized condition, breakdown might occur due to abnormal heating depending on the carrying condition. Therefore, please inquire when using with a circuit that causes an energized condition on both sides simultaneously.

REFERENCE DATA

1.-(1) Coil temperature rise (at room temperature)

Sample: ACTE3H2, 3pcs.
Contact carrying current: 0A, 10A, 20A
Ambient temperature: Room temperature

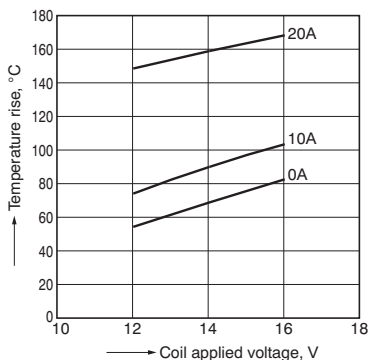

1.-(2) Coil temperature rise (at 110°C 230°F)

Sample: ACTE3H2, 3pcs.
Contact carrying current: 0A, 10A, 20A
Ambient temperature: 110°C 230°F

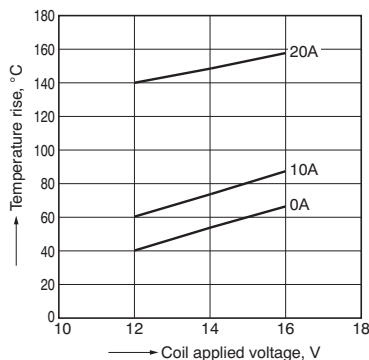

2. Ambient temperature and operating voltage range

Sample: ACTE3H2

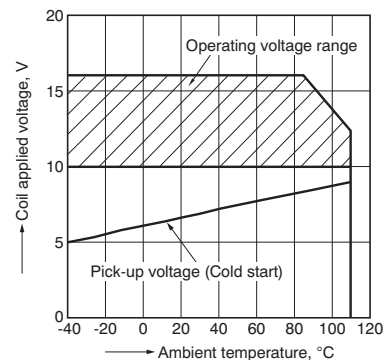

3. Distribution of pick-up and drop-out voltage

Sample: ACTE3H2, 40 × 2 pcs.

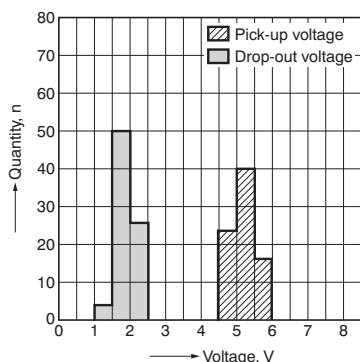

4. Distribution of operate and release time

Sample: ACTE3H2, 40 × 2 pcs.

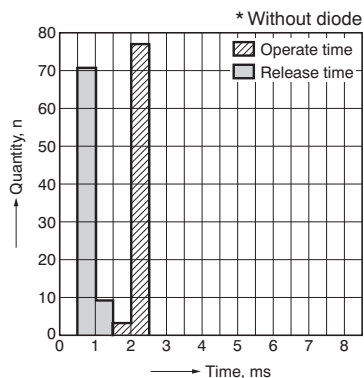

5.-(1) Electrical life test (Motor lock)

Sample: ACTE3H2, 3pcs.

Load: 25A 14V DC

Power window motor actual load (lock condition)

Operating frequency: ON 0.5s, OFF 9.5s

Ambient temperature: Room temperature

Circuit:

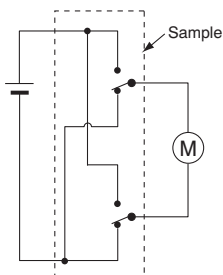

Change of pick-up and drop-out voltage

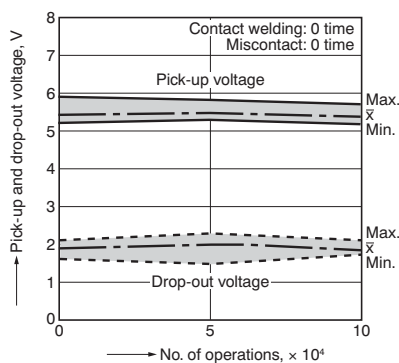

Change of contact resistance

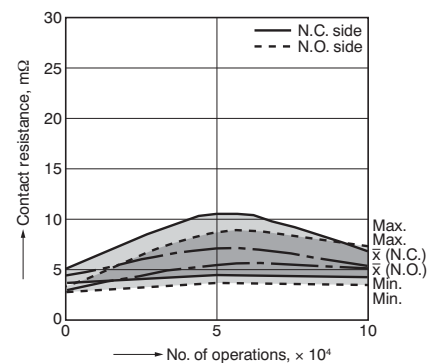

Load current waveform

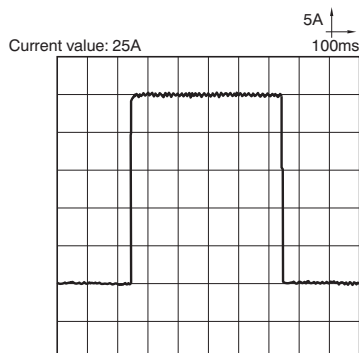

TE (ACTE)

DIMENSIONS (mm inch)

1 Form C type



External dimensions

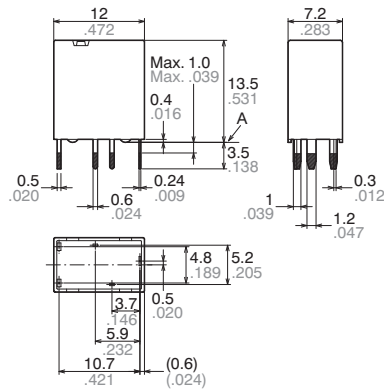

PC board pattern (Bottom view)

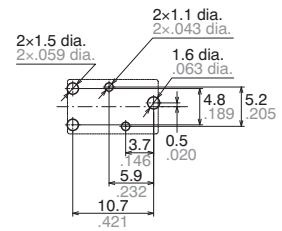

Tolerance: $\pm 0.1 \pm .004$

Schematic (Bottom view)

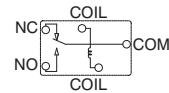

Dimension:

Less than 1mm .039inch:

Min. 1mm .039inch less than 3mm .118 inch: $\pm 0.2 \pm .008$

Min. 3mm .118 inch:

Tolerance

$\pm 0.1 \pm .004$

$\pm 0.2 \pm .008$

$\pm 0.3 \pm .012$

* Dimensions (thickness and width) of terminal is measured before pre-soldering. Intervals between terminals is measured at A surface level.

Twin type (8 terminals type)



External dimensions

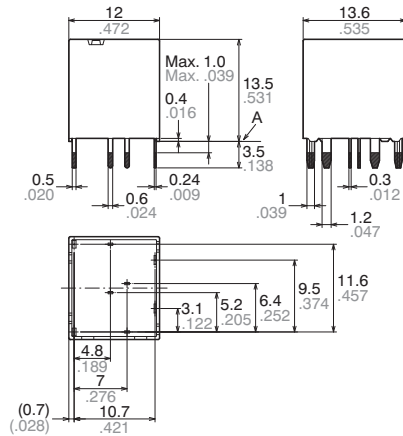

PC board pattern (Bottom view)

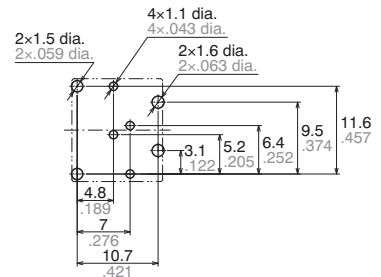

Tolerance: $\pm 0.1 \pm .004$

Schematic (Bottom view)

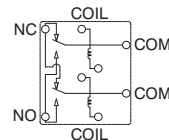

Dimension:

Less than 1mm .039inch:

Min. 1mm .039inch less than 3mm .118 inch: $\pm 0.2 \pm .008$

Min. 3mm .118 inch:

Tolerance

$\pm 0.1 \pm .004$

$\pm 0.2 \pm .008$

$\pm 0.3 \pm .012$

* Dimensions (thickness and width) of terminal is measured before pre-soldering. Intervals between terminals is measured at A surface level.

1 Form C type Pin in Paste type



External dimensions

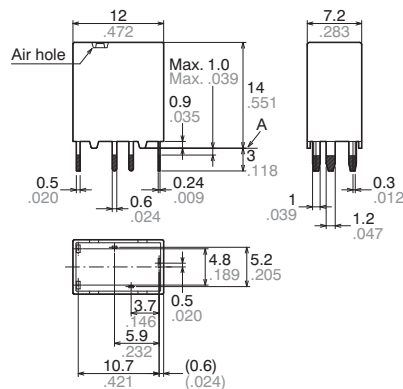

PC board pattern (Bottom view)

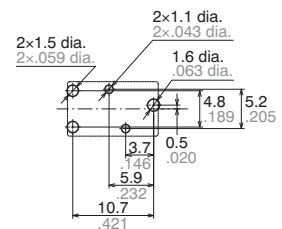

Tolerance: $\pm 0.1 \pm .004$

Schematic (Bottom view)

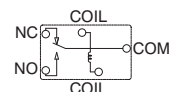

Dimension:

Less than 1mm .039inch:

Min. 1mm .039inch less than 3mm .118 inch: $\pm 0.2 \pm .008$

Min. 3mm .118 inch:

Tolerance

$\pm 0.1 \pm .004$

$\pm 0.2 \pm .008$

$\pm 0.3 \pm .012$

* Dimensions (thickness and width) of terminal is measured before pre-soldering. Intervals between terminals is measured at A surface level.

**Twin type (8 terminals type)
Pin in Paste type**



External dimensions

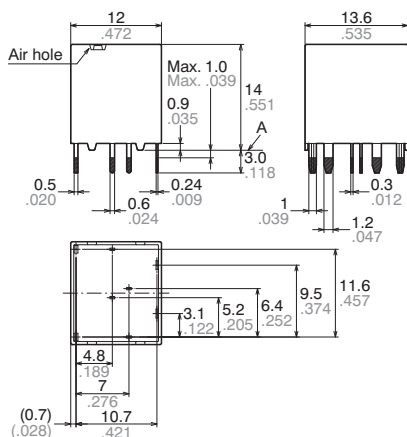

Dimension:	Tolerance
Less than 1mm .039inch:	$\pm 0.1 \pm 0.004$
Min. 1mm .039inch less than 3mm .118 inch:	$\pm 0.2 \pm 0.008$
Min. 3mm .118 inch:	$\pm 0.3 \pm 0.012$

PC board pattern (Bottom view)

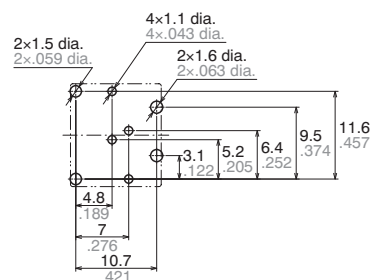

Tolerance: $\pm 0.1 \pm 0.004$

Schematic (Bottom view)

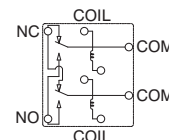

* Dimensions (thickness and width) of terminal is measured before pre-soldering. Intervals between terminals is measured at A surface level.

NOTES

Usage, transport and storage conditions

- 1) Ambient temperature, humidity, and atmospheric pressure during usage, transport, and storage of the relay:
 - (1) Temperature: -40 to $+110^{\circ}\text{C}$ -40 to $+230^{\circ}\text{F}$ (High heat-resistant type/Pin in Paste type)
 - (2) Humidity: 2 to 85% RH (Avoid freezing and condensation.)
 - (3) Atmospheric pressure: 86 to 106 kPa
The humidity range varies with the temperature. Use within the range indicated in the graph below.
(Temperature and humidity range for usage, transport, and storage)

- 2) Condensation
Condensation forms when there is a sudden change in temperature under high temperature and high humidity conditions. Condensation will cause deterioration of the relay insulation.

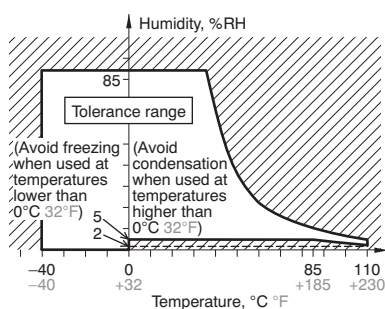

For Cautions for Use, see [Relay Technical Information](#).