

SWITCHING REGULATOR APPLICATION

Features

- High voltage: $BV_{DSS}=250V$ (Min.)
- Low gate charge: $Q_g=14.5nC$ (Typ.)
- Low drain-source On resistance: $R_{DS(on)}=0.43\Omega$ (Max.)
- 100% avalanche tested
- RoHS compliant device

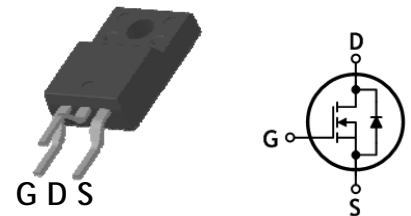

Ordering Information

Part Number	Marking	Package
SMK0825FZ	SMK0825	TO-220F-3L (Z-Forming)

TO-220F-3L

Marking Information

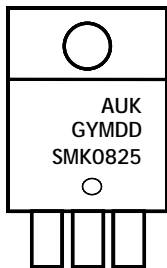

Column 1 : Manufacturer
 Column 2 : Production Information
 e.g.) GYMDD
 -. G : Factory Management Code
 -. YMDD : Date Code (Year, Month, Date)
 Column 3 : Device Code

Absolute maximum ratings ($T_c=25^\circ C$ unless otherwise noted)

Characteristic	Symbol	Rating	Unit	
Drain-source voltage	V_{DSS}	250	V	
Repetitive Avalanche Voltage ^(Note 1, 2)	$V_{DS(Avalanche)}$	300	V	
Gate-source voltage	V_{GSS}	± 30	V	
Drain current (DC) *	I_D	$T_c=25^\circ C$	8	A
		$T_c=100^\circ C$	5.2	A
Drain current (Pulsed) *	I_{DM}	32	A	
Single pulsed avalanche energy ^(Note 2)	E_{AS}	356	mJ	
Repetitive avalanche current ^(Note 1)	I_{AR}	8	A	
Repetitive avalanche energy ^(Note 1)	E_{AR}	7.4	mJ	
Power dissipation	P_D	29	W	
Junction temperature	T_J	150	$^\circ C$	
Storage temperature range	T_{stg}	-55~150	$^\circ C$	

* Limited only maximum junction temperature

Thermal Characteristics

Characteristic	Symbol	Rating	Unit
Thermal resistance, junction to case	$R_{th(j-c)}$	Max. 4.31	°C/W
Thermal resistance, junction to ambient	$R_{th(j-a)}$	Max. 62.5	

Electrical Characteristics ($T_C=25^\circ\text{C}$ unless otherwise noted)

Characteristic	Symbol	Test Condition	Min.	Typ.	Max.	Unit
Drain-source breakdown voltage	BV_{DSS}	$I_D=250\mu\text{A}, V_{GS}=0$	250	-	-	V
Gate threshold voltage	$V_{GS(th)}$	$I_D=250\mu\text{A}, V_{DS}=V_{GS}$	2	-	4	V
Drain-source cut-off current	I_{DSS}	$V_{DS}=250\text{V}, V_{GS}=0\text{V}$	-	-	1	μA
Gate leakage current	I_{GSS}	$V_{DS}=0\text{V}, V_{GS}=\pm 30\text{V}$	-	-	± 100	nA
Drain-source on-resistance	$R_{DS(on)}$	$V_{GS}=10\text{V}, I_D=4\text{A}$	-	0.35	0.43	Ω
Internal gate resistance	R_G	$f=1\text{MHz}, V_{DS}=0\text{V}$	-	4	10	Ω
Forward transfer conductance (Note 3)	g_{fs}	$V_{DS}=10\text{V}, I_D=4\text{A}$	-	7	-	S
Input capacitance	C_{iss}	$V_{DS}=25\text{V}, V_{GS}=0\text{V}, f=1\text{MHz}$	-	619	773	pF
Output capacitance	C_{oss}		-	141	176	
Reverse transfer capacitance	C_{rss}		-	33	41	
Turn-on delay time (Note 3,4)	$t_{d(on)}$	$V_{DD}=125\text{V}, I_D=8\text{A}, R_G=25\Omega$	11	15	35	ns
Rise time (Note 3,4)	t_r		32	85	115	
Turn-off delay time (Note 3,4)	$t_{d(off)}$		62	90	135	
Fall time (Note 3,4)	t_f		41	65	98	
Total gate charge (Note 3,4)	Q_g	$V_{DS}=200\text{V}, V_{GS}=10\text{V}, I_D=8\text{A}$	-	14.5	18.2	nC
Gate-source charge (Note 3,4)	Q_{gs}		-	4	-	
Gate-drain charge (Note 3,4)	Q_{gd}		-	4.5	-	

Source-Drain Diode Ratings and Characteristics ($T_C=25^\circ\text{C}$ unless otherwise noted)

Characteristic	Symbol	Test Condition	Min.	Typ.	Max.	Unit
Source current (DC)	I_S	Integral reverse diode in the MOSFET	-	-	8	A
Source current (Pulsed)	I_{SM}		-	-	32	A
Forward voltage	V_{SD}	$V_{GS}=0\text{V}, I_S=8\text{A}$	-	-	1.4	V
Reverse recovery time (Note 3,4)	t_{rr}	$I_S=8\text{A}, V_{GS}=0\text{V}, di_F/dt=100\text{A}/\mu\text{s}$	-	178	-	ns
Reverse recovery charge (Note 3,4)	Q_{rr}		-	1.16	-	μC

Note:

1. Repeated rating: Pulse width limited by maximum junction temperature
2. $L=8.9\text{mH}, I_{AS}=8\text{A}, V_{DD}=50\text{V}, R_G=25\Omega$, Starting $T_J=25^\circ\text{C}$
3. Pulse test: Pulse width $\leq 300\mu\text{s}$, Duty cycle $\leq 2\%$
4. Essentially independent of operating temperature typical characteristics

Electrical Characteristic Curves

Fig. 1 $I_D - V_{DS}$

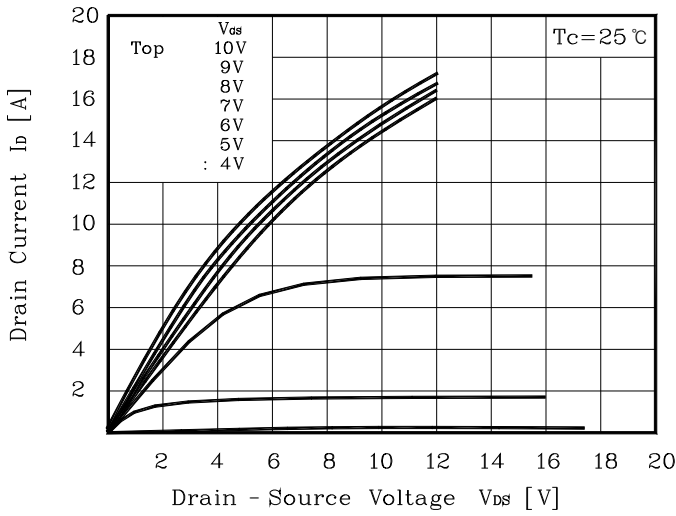

Fig. 2 $I_D - V_{GS}$

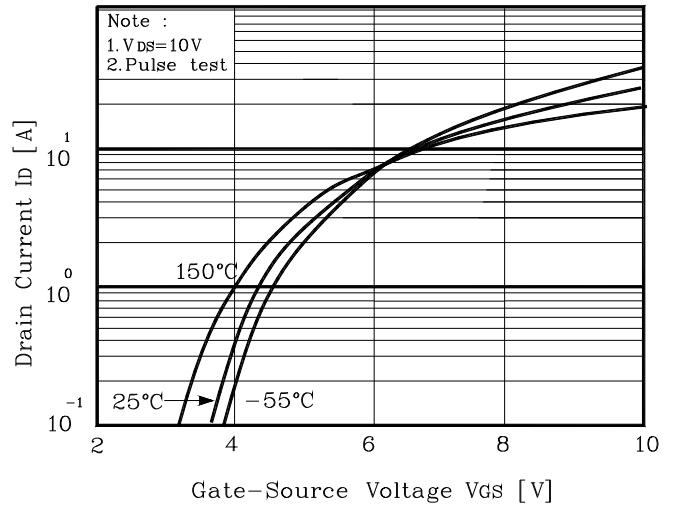

Fig. 3 $R_{DS(ON)} - I_D$

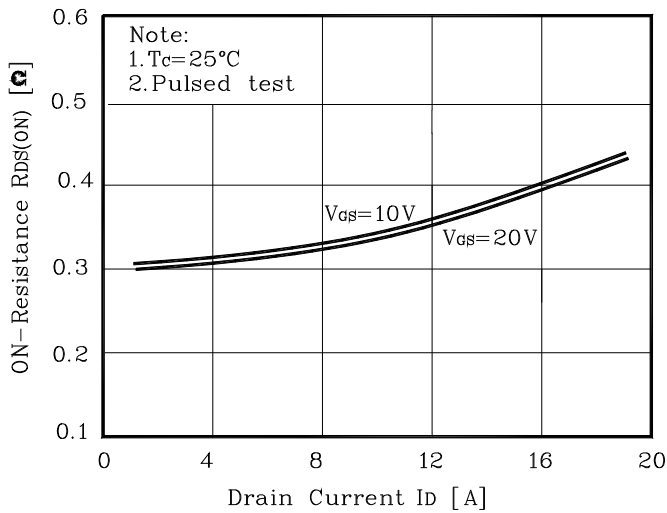

Fig. 4 $I_S - V_{SD}$

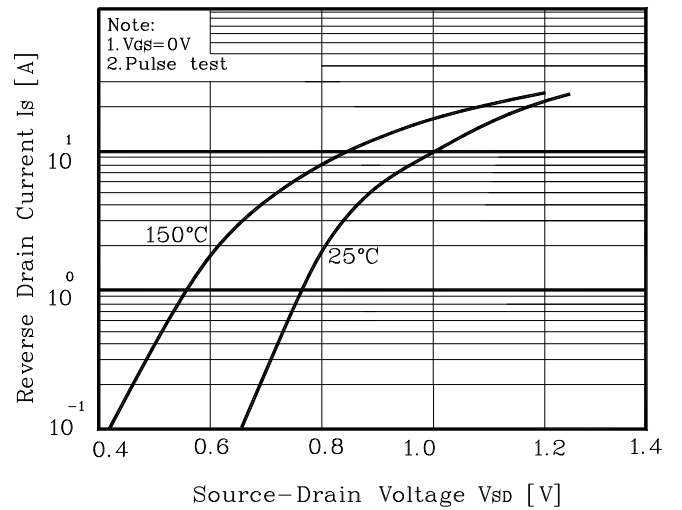

Fig. 5 Capacitance - V_{DS}

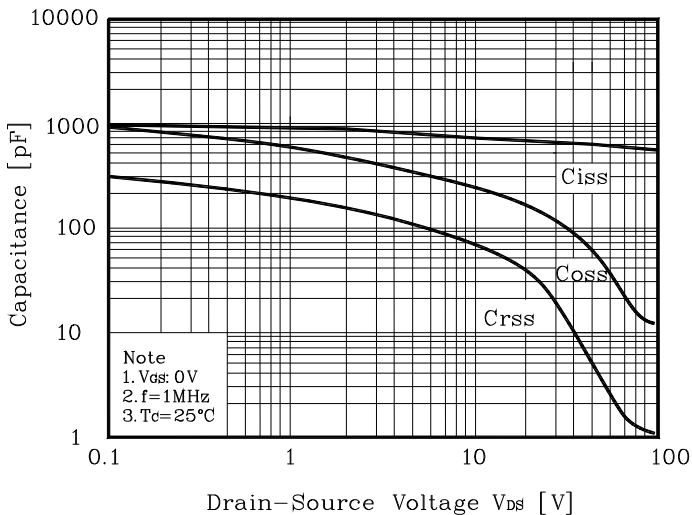
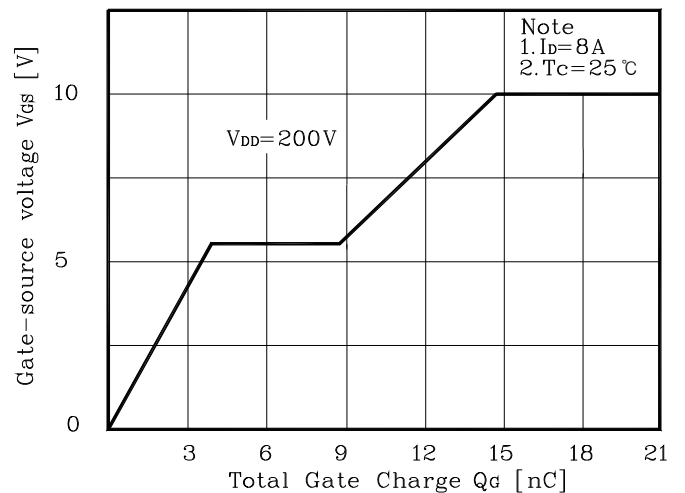

Fig. 6 $V_{GS} - Q_G$



Electrical Characteristic Curves (Continue)

Fig. 7 $V_{DSS} - T_J$

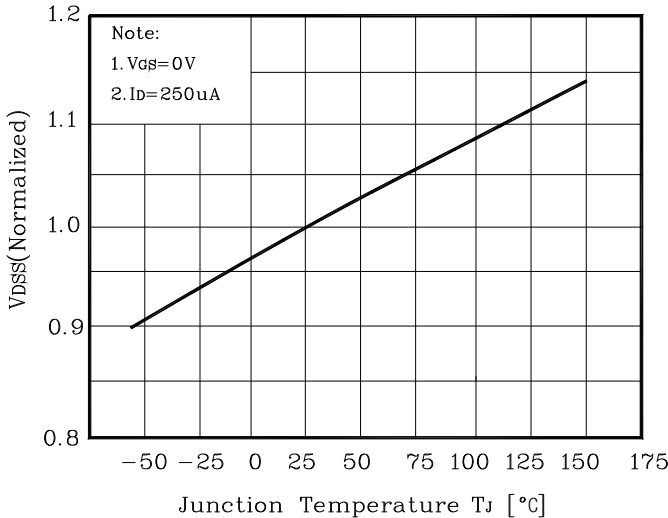

Fig. 8 $R_{DS(ON)} - T_J$

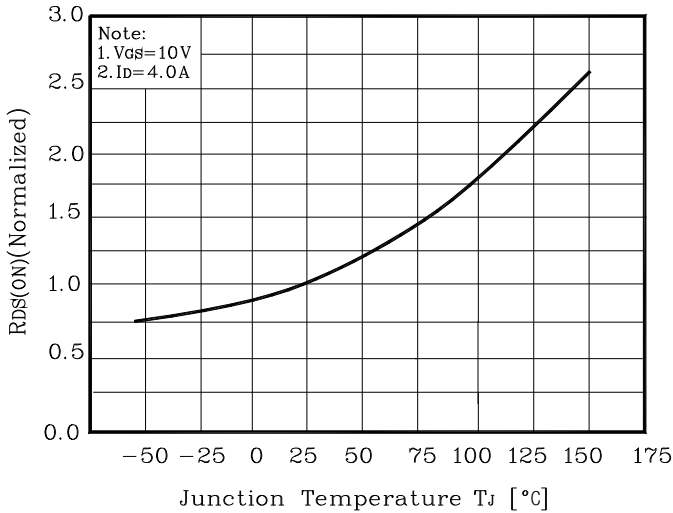

Fig. 9 $I_D - T_C$

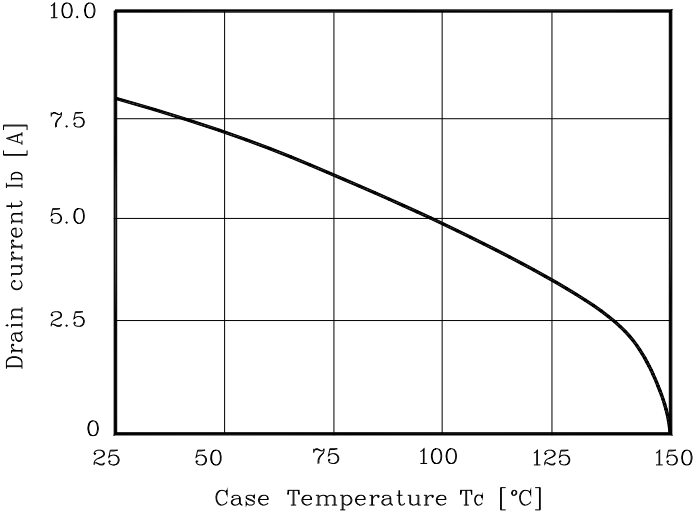

Fig. 10 Safe Operating Area

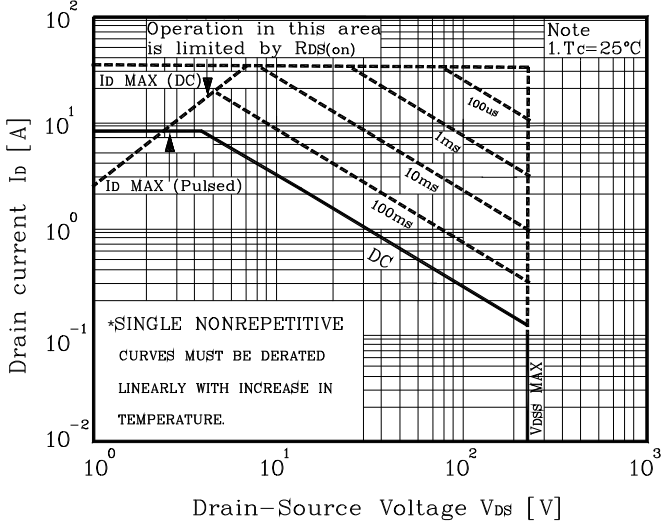

Fig. 11 Gate Charge Test Circuit & Waveform

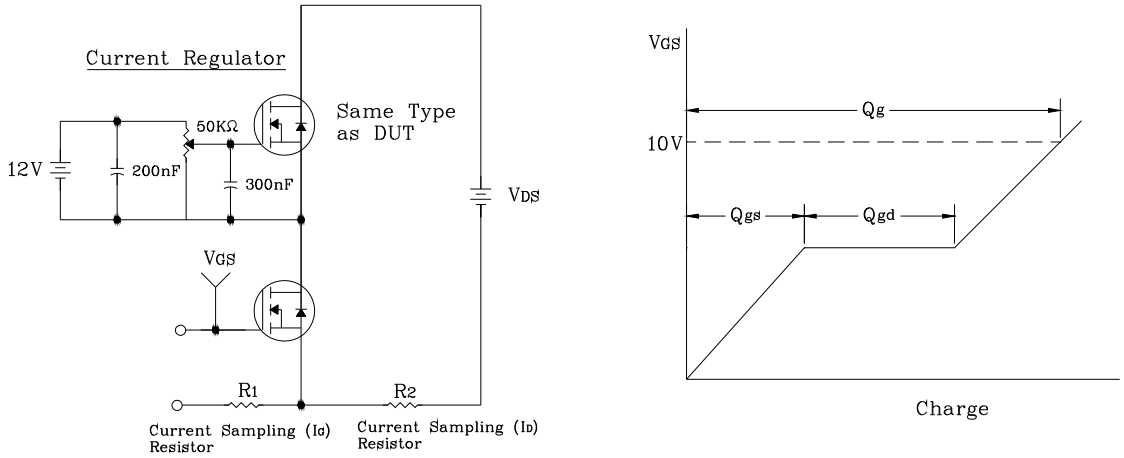

Fig. 12 Resistive Switching Test Circuit & Waveform

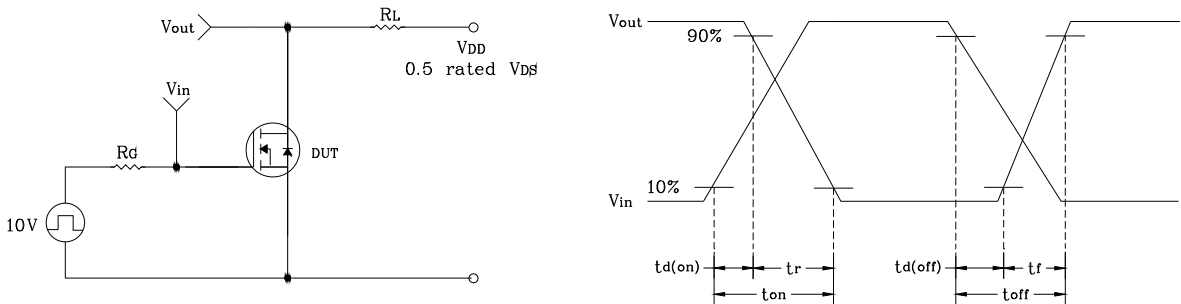

Fig. 13 E_{AS} Test Circuit & Waveform

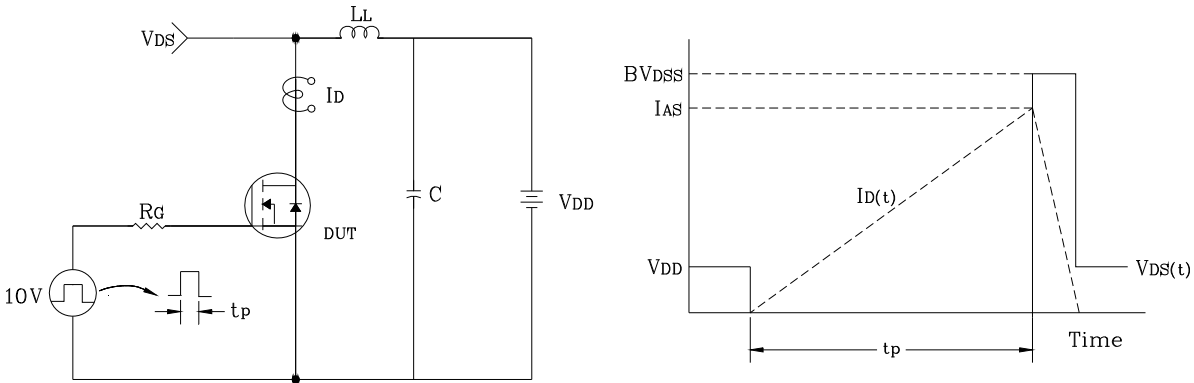
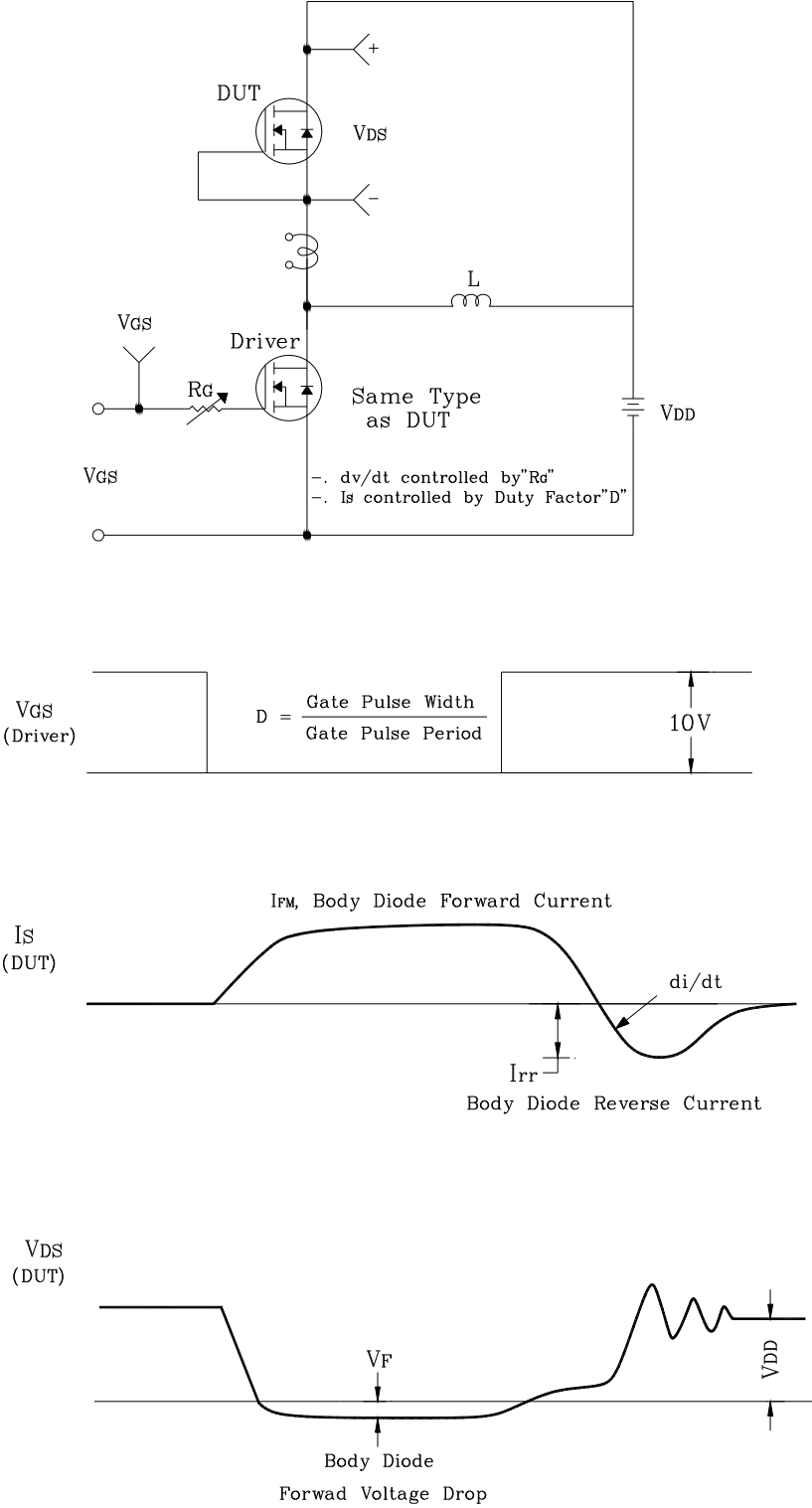
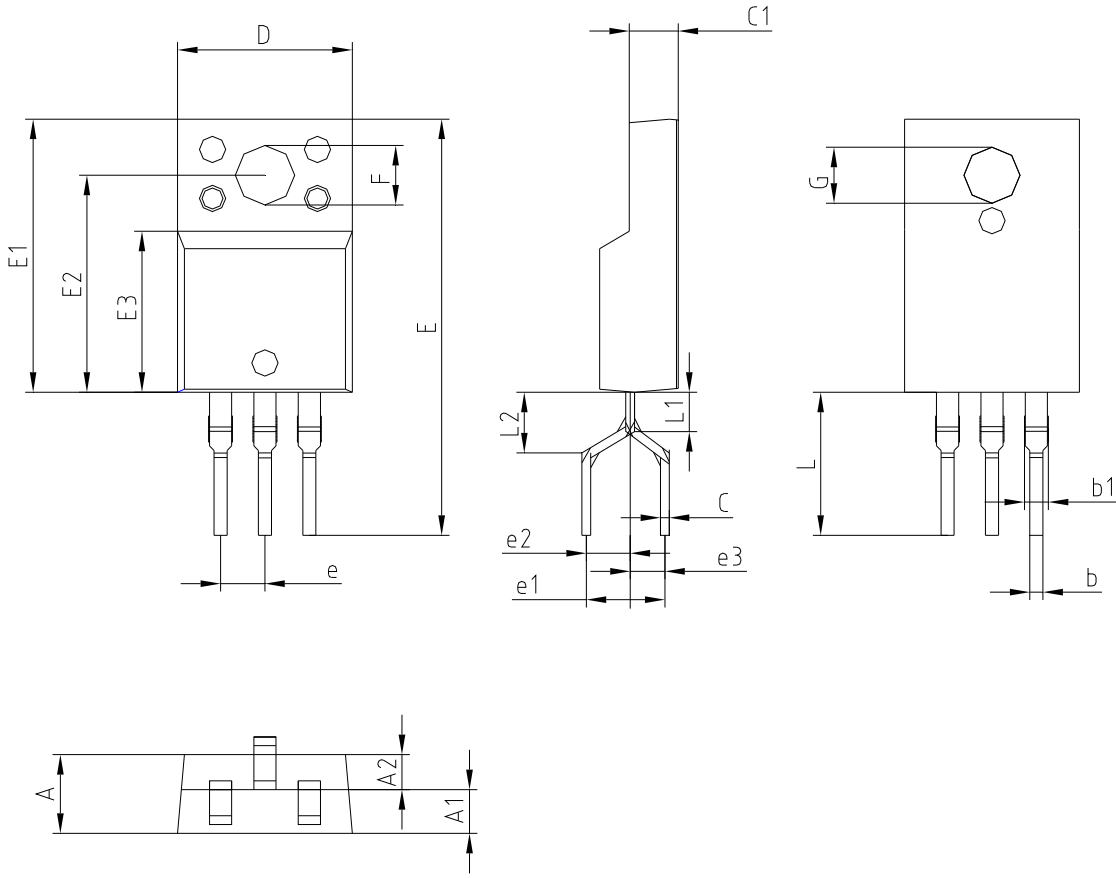

Fig. 14 Diode Reverse Recovery Time Test Circuit & Waveform



Package Outline Dimensions



SYMBOL	MILLIMETERS			NOTE
	MINIMUM	NOMINAL	MAXIMUM	
A	-	-	4.60	
A1	2.45	2.50	2.55	
A2	1.95	2.00	2.05	
b	0.65	0.75	0.85	
b1	1.07	1.27	1.47	
C	0.40	0.50	0.60	
C1	2.70	2.80	2.90	
D	9.90	10.00	10.10	
E	22.77	-	24.77	
E1	15.50	15.60	15.70	
E2	12.30	12.40	12.50	
E3	9.15	9.20	9.25	
F	3.30	3.40	3.50	
G	3.10	3.20	3.30	
e	2.54 BSC			
e1	4.20	4.50	4.80	
e2	2.51 BSC			
e3	1.99 BSC			
L	7.17	-	9.17	
L1	2.25 BSC			
L2	3.46 BSC			

The AUK Corp. products are intended for the use as components in general electronic equipment (Office and communication equipment, measuring equipment, home appliance, etc.).

Please make sure that you consult with us before you use these AUK Corp. products in equipments which require high quality and / or reliability, and in equipments which could have major impact to the welfare of human life(atomic energy control, airplane, spaceship, transportation, combustion control, all types of safety device, etc.). AUK Corp. cannot accept liability to any damage which may occur in case these AUK Corp. products were used in the mentioned equipments without prior consultation with AUK Corp..

Specifications mentioned in this publication are subject to change without notice.