

RM68120 Data Sheet

Single Chip Driver with 16.7M color

for 480RGBx864 a-Si TFT LCD

Revision : 0.0

Date : May 20, 2011

Revision History

Version No.	Date	Page	Description
0.0	2011/06/02	P113	Update OTP program flow chart

CONFIDENTIAL

Table of Contents

1. General Description	7
2. Features	6
3. Block Diagram	9
4. Pin Description.....	10
5. Pad Diagram and Coordination.....	20
6. Block Function Description	41
7. Function Description.....	43
7.1 Interface Type Selection.....	43
7.2 Display Bus Interface (DBI).....	44
7.2.1 Write Cycle	45
7.2.2 Read Cycle	46
7.3 Serial Interface	50
7.3.1 Write Cycle and Sequence	50
7.3.2 Read Cycle and Sequence	57
7.3.3 Break and Pause Sequences.....	64
7.4 I2C Interface	65
7.5 Display Pixel Interface (DPI).....	70
7.6 Display Serial Interface (DSI).....	72
7.6.1 DSI Protocol.....	73
7.6.2 Processor to Peripheral Transactions	75
7.6.3 Peripheral-to-Processor LP Transmission	80
7.6.4 Notice	83
7.7 MDDI Interface.....	84
7.7.1 MDDI Link Protocol.....	85
7.7.2 MDDI Link Packet Descriptions.....	86
7.7.3 Writing Video Data to Memory Sequence	99
7.7.4 Writing Register Sequence.....	100
7.7.5 Reading Video Data from Memory Sequence	100
7.7.6 Reading Register Sequence.....	101
7.7.7 Hibernation Setting	102
7.7.8 MDDI Deep Standby Mode Setting.....	103
7.8 Display Data RAM.....	105
7.8.1 Configuration	105
7.8.2 Memory to Display Address Mapping.....	106
7.9 Tearing Effect Output.....	107
7.9.1 Tearing Effect Line Mode	107
7.9.2 Tearing Effect Line Timing.....	109
7.10 Panel Type.....	110
7.10.1 Normal Type.....	110
7.10.2 Zigzag Type 1.....	110
7.10.3 Zigzag Type 2.....	111
7.10.4 Zigzag Type 3.....	111
7.10.5 ZigZag Type 4	112
7.11 OTP Program Sequence	113

7.12 Independent Gamma Correction Function	114
7.13 Dynamic Backlight Control	115
7.13.1 PWM Control Architecture	116
7.13.2 Dimming Function for LABC and Manual Brightness Control	120
7.13.3 PWM Signal Setting for CABC and LABC	123
7.13.4 Content Adaptive Brightness Control (CABC)	125
7.13.5 Light-Sensor Automatic Brightness Control (LABC)	126
8. Command	135
8.1. Command List	135
8.2. Command Description	137
NOP (0000h)	137
SWRESET(0100h) : Software Reset	138
RDDID(0400h~0402h) : Read Display ID	140
RDNUMED(0500h) : Read Number of Errors on DSI	142
RDDPM (0A00h) : Read Display Power Mode	144
RDDMADCTR (0B00h): Read Display MADCTR	146
RDDCOLMOD (0C00h): Read Display Pixel Format	148
RDDIM (0D00h): Read Display Image Mode	150
RDDSM (0E00h): Read Display Signal Mode	152
RDDSDR (0F00h): Read Display Self-Diagnostic Result	154
SLPIN (1000h): Sleep In	156
SLPOUT (1100h): Sleep Out	158
PTLON (1200h): Partial Display Mode On	160
NORON (1300h): Normal Display Mode On	161
INVOFF (2000H): Display Inversion Off	162
INVON (2100H): Display Inversion On	164
ALLPOFF (2200H): All Pixel Off	166
ALLPON (2300H): All Pixel On	168
GAMSET (2600H): Gamma Set	170
DISPOFF (2800h): Display Off	172
DISPON (2900h): Display On	174
CASET (2A00h): Column Address Set	176
RASET (2B00h): Row Address Set	179
RAMWR (2C00h): Memory Write	182
RAMRD (2E00h): Memory Read	184
PTLAR (3000h): Partial Area	186
TEOFF (3400h): Tearing Effect Line OFF	189
TEON (3500h): Tearing Effect Line ON	190
MADCTR (3600h): Memory Data Access Control	192
IDMOFF (3800h): Idle Mode Off	195
IDMON (3900h): Enter_idle_mode	196
COLMOD (3A00h): Interface Pixel Format	198
RAMWRC(3C00h) : Write_Memory_Continue	200
RAMRDC(3E00h) : Read_Memory_Continue	202
STESL(4400h) : Set_Tear_Scanline	204
GSL (4500h) : Get_Scanline	206
DSTBON (4F00h): Deep Standby Mode On	207
WRPFD(50h) : Write Profile Value for Display	208

WRDISBV (5100h): Write Display Brightness	210
RDDISBV (5200h): Read Display Brightness.....	212
WRCTRLD (5300h): Write CTRL Display	213
RDCTRLD (5400h): Read CTRL Display Value	216
WRCABC (5500h): Write Content Adaptive Brightness Control	219
RDCABC (5600h): Read Content Adaptive Brightness Control.....	221
WRHYSTE (5700h): Write Hysteresis.....	223
WRGAMMASET (5800h): Write Gamma Setting.....	225
RDFSVM (5A00h): Read FS Value MSBs.....	227
RDFSVL (5B00h): Read FS Value LSBs	229
RDMFFSVM (5C00h): Read Median Filter FS Value MSBs	231
RDMFFSVL (5D00h): Read Median Filter FS Value LSBs	233
WRCABCMB (5E00h): Write CABC Minimum Brightness.....	235
RDCABCMB (5F00h): Read CABC Minimum Brightness.....	236
WRLSCC (6500h): Write Light Sensor Compensation Coefficient Value.....	237
RDLSCCM (6600h): Read Light Sensor Compensation Coefficient Value MSBs.....	238
RDLSCCL (6700h): Read Light Sensor Compensation Coefficient Value LSBs	240
RDBWLB (7000h): Read Black/White Low Bits.....	242
RDBkx (7100h): Read Bkx.....	243
RDBky (7200h): Read Bky.....	244
RDWx (7300h): Read Wx.....	245
RDWy (7400h): Read Wy.....	246
RDRGLB (7500h): Read Red/Green Low Bits	247
RDRx (7600h): Read Rx.....	248
RDRy (7700h): Read Ry.....	249
RDGx (7800h): Read Gx.....	250
RDGy (7900h): Read Gy.....	251
RDBALB (7A00h): Read Red/Green Low Bits	252
RDBx (7B00h): Read Rx.....	253
RDBy (7C00h): Read By.....	254
RDAx (7D00h): Read Ax.....	255
RDAY (7E00h): Read Ay.....	256
RDDDBS(A1h) : Read_DDB_Start (A1h).....	257
RDDDBC(A800h) : Read DDB Contin.....	259
RDFCS(AA00h) : Read First Checksum.....	261
RDCCS(AF00h) : Read Continue Checksum.....	263
RDID1(DA00h) : Read ID1	265
RDID2(DB00h) : Read ID2	266
RDID3(DC00h) : Read ID3	268
9. Electrical Characteristics.....	270
9.1 Absolute Maximum Ratings.....	270
9.2 ESD Protection Level	270
9.3 Latch-Up Protection Level.....	270
9.4 Light Sensitivity.....	270
9.5 DC Characteristics	271
9.5.1 Basic Characteristics	271
9.5.2 MIPI Characteristics	272
9.5.3 MDDI Characteristics	276

9.6 AC Characteristics	277
9.6.1 Parallel Interface Characteristics (80-Series MCU).....	277
9.6.2 Serial Interface Characteristics	278
9.6.3 I2C Bus Timing Characteristics	279
9.6.4 RGB Interface Characteristics	280
9.6.5 DSI Timing Characteristics	281
9.6.6 MDDI Timing Characteristics.....	286
9.6.7 Reset Timing	287

CONFIDENTIAL

1. General Description

RM68120 is a 16.7 million-color single-chip SoC driver for a-si TFT LCD driver IC that supply resolution of 480RGBx360, 480RGBx640, 480RGBx720, 480RGBx800, 480RGBx854, 480RGBx864 with internal GRAM and 480RGB x 1024 by pass internal GRAM. RM68120 comprise a 1440-channel source driver, gate control timing by level shift, 1,244,160 bytes GRAM for graphic data of 480RGBx864 dots, and power supply circuit.

The RM68120 supports 24-/16-/8-bit data bus interface, I2C interface and serial peripheral interfaces (SPI). It also supplies 24bit, 18-bit or 16-bit RGB interface, MDDI interface and MIPI interface for driving video signal directly from application controller. The moving picture area can be specified in internal GRAM by window address function. The specified window area can be updated selectively, so that moving picture can be displayed simultaneously independent of still picture area.

RM68120 can operate with 1.65V I/O interface voltage, and an incorporated voltage follower circuit to generate voltage levels for driving a TFT LCD panel. The RM68120 also supports a function to display in 8 colors and a sleep mode, allowing for precise power control by software and these features make the RM68120 an ideal driver for portable products such as digital cellular phones, smart phone, MP3 and PMP where long battery life is a major concern.

2. Features

- A single-chip controller driver for a WVGA panel type a-si TFT LCD display
- Display resolution option
 - (1). With GRAM:
 1. 480RGB x 360
 2. 480RGB x 640
 3. 480RGB x 720
 4. 480RGB x 800
 5. 480RGB x 854
 6. 480RGB x 864
 - (2). By pass GRAM:
 1. 480RGB x 1024
- RAM size: $480 \times 3 \times 864 = 1,244,160$ bytes
- System interface
 - (1). 8-, 16-, 24-bits 80-series MPU interface
 - (2). 16-bits serial peripheral interface
 - (3). I2C interface
- Moving picture display interface
 - (1). 16-, 18-, 24-bit RGB interface (SYNC and DE mode)
- High speed interface
 - (1). Mobile Display Digital Interface (MDDI V1.2, 1 clock and 1 or 2 data lane pairs)
 - (2). MIPI Display Serial Interface (DSI V1.01 r11 and D-PHY V1.0, 1 clock and 1 or 2 data lane pairs)
- Display color mode
 - (1). Full color mode: 16.7M colors
 - (2). Reduce color mode:
 1. 262k colors
 2. 65k colors

3. 8 colors (Idle mode)

- Window address function to specify a rectangular area writing data in the internal RAM

- Abundant color display and drawing functions

(1). Programmable γ -correction function for 16.7 million color display

(2). Individual gamma correction setting for RGB dots

(3). Partial display function

- Low power consumption architecture

(1). Deep standby mode

(2). Sleep mode

(3). 8-color display function

- Power supply startup sequencer

- Support 1-, 2-, 3-, 4-dot, column and zigzag inversion

- Four GPO pins for external control

- On chip checksums check

- Operating temperate: $-30^{\circ}\text{C} \sim 70^{\circ}\text{C}$

- On module DC/DC converter

(1). DDVDH=4.5V to 6.5V

(2). DDVDL=-4.5V to -6.5V

(3). VCL=-2.5V to -4.0V

(4). Positive gamma high voltage level: VGMP=3.5V to 5V

(5). Positive gamma low voltage level: VGSP=0.0V, 0.3V to 3.7V

(6). Negative gamma high voltage level: VGMP=-5V to -3.5V

(7). Negative gamma low voltage level: VGSP=0.0V, -0.3V to -3.7V

(8). Positive gate driver output voltage level: VGH=+8V to +18V

(9). Negative gate driver output voltage level: VGL=-2V to -15V

(10). VCOM=-3.5V to 0V

- Input power supply voltages:

(1). IOVCC (VDDI) = 1.65V~3.3V

(2). IOVCCCL (VDDIL) = 1.1V~1.3V

(3). VCI = 2.3V~4.8V

(4). MIPI/MDDI regulator supply voltage range: 2.3V ~ 4.8V

CONFIDENTIAL

3. Block Diagram

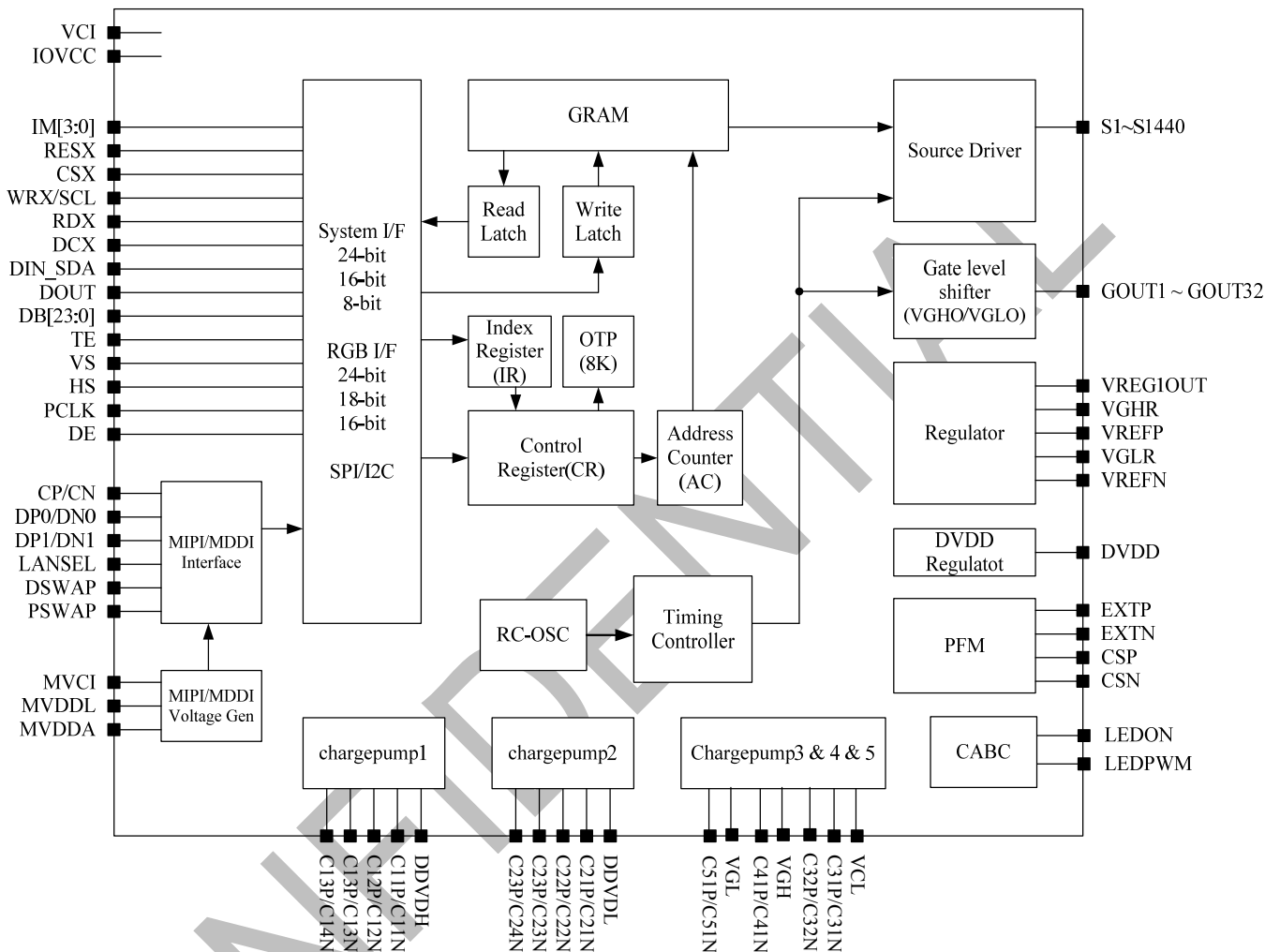

4. Pin Description

80-System Interface Pins		
Pin Name	I/O	Descriptions
CSX	I	Chip select input pin ("Low" enable) in 80-series MPU I/F and SPI I/F.
WRX / SCL / I2C_SCL	I	WRX: Writes strobe signal to write data when WRX is "Low" in 80-series MPU I/F. SCL: A synchronous clock signal in SPI I/F. I2C_SCL: Serial input clock in I2C I/F.
RDX	I	Reads strobe signal to write data when RDX is "Low" in 80-series MPU interface.
D/CX	I	Display data / command selection in 80-series MPU I/F. D/CX = "0" : Command D/CX = "1" : Display data or Parameter
D[23:0]	I/O	24-bit bi-directional data bus for 80-series MPU I/F and 24-bit input data bus for RGB I/F. For 8080-series MPU I/F: 8-bit interface: D[7:0] are used, D[23:8] should be connected to VSSI 16-bit interface: D[15:0] are used, D[23:16] should be connected to VSSI 24-bit interface: D[23:0] are used
SPI / I2C Interface Pins		
Pin Name	I/O	Descriptions
SDI / I2C_SDA	I/O	SDI: Serial input signal in SPI I/F. The data is input on the rising/falling edge of the SCL signal. I2C_SDA: Serial input/output signal in I2C I/F. The data is input/output on the rising edge of the I2C_SCL signal.
SDO	O	Serial output signal in SPI I/F. The data is output on the rising/falling edge of the SCL signal. If the host places the SDI line into high-impedance state during the read interval, the SDI and SDO can be tied together.
RGB Interface Pins		
Pin Name	I/O	Descriptions
PCLK	I	Pixel clock signal in RGB I/F.
VS	I	Vertical sync. Signal in RGB I/F.
HS	I	Horizontal sync. Signal in RGB I/F.
DE	I	Data enable signal in RGB I/F DE mode.
MIPI / MDDI Interface Pins		
Pin Name	I/O	Descriptions

HSSI_CLK_P HSSI_CLK_N	I	These pins are DSI-CLK+/- differential clock signals if MIPI interface is used. These pins are MDDI_STB_P/N differential strobe signals if MDDI interface is used. HSSI_CLK_P/N are differential small amplitude signals. Ensure the trace length is shortest so that the COG resistance is less than 10 ohm. Please connect these pins to VSSAM if not used.																																			
HSSI_D0_P HSSI_D0_N	I/O	These pins are DSI-D0+/- differential data signals if MIPI interface is used. These pins are MDDI_DATA0_P/N differential strobe signals if MDDI interface is used. HSSI_D0_P/N are differential small amplitude signals. Ensure the trace length is shortest so that the COG resistance is less than 10 ohm. Please connect these pins to VSSAM if not used.																																			
HSSI_D1_P HSSI_D1_N	I	These pins are DSI-D1+/- differential data signals if MIPI interface is used. These pins are MDDI_DATA1_P/N differential strobe signals if MDDI interface is used. HSSI_D1_P/N are differential small amplitude signals. Ensure the trace length is shortest so that the COG resistance is less than 10 ohm. Please connect these pins to VSSAM if not used.																																			
ERR	O	CRC and ECC error output pin for MIPI interface. This pin is output low when it is not activated. When this pin is activated, it output high if CRC/ECC error found. Please open this pin if not used.																																			
LANSEL	I	Input pin to select 1 data lane or 2 data lanes in MIPI/MDDI interface. 0: 1 data lane 1: 2 data lanes Please connect to VSSI if not used.																																			
DSWAP PSWAP	I	Input pin to select HSSI_D0/D1 data lane sequence and polarity in high speed interface only. For MIPI interface, both DSWAP and PSWAP function are available. For MDDI interface, only PSWAP function is available. i.e. DSWAP=1 in below table is invalid. <table border="1" style="width: 100%; border-collapse: collapse;"> <thead> <tr> <th>Pin Name</th> <th>HSSI_D0_P</th> <th>HSSI_D0_N</th> <th>HSSI_CLK_P</th> <th>HSSI_CLK_N</th> <th>HSSI_D1_P</th> <th>HSSI_D1_N</th> </tr> </thead> <tbody> <tr> <td>DSWAP=0 PSWAP=0</td> <td>DSI-D0+</td> <td>DSI-D0-</td> <td>DSI-CLK+</td> <td>DSI-CLK-</td> <td>DSI-D1+</td> <td>DSI-D1-</td> </tr> <tr> <td>DSWAP=0 PSWAP=1</td> <td>DSI-D0-</td> <td>DSI-D0+</td> <td>DSI-CLK-</td> <td>DSI-CLK+</td> <td>DSI-D1-</td> <td>DSI-D1+</td> </tr> <tr> <td>DSWAP=1 PSWAP=0</td> <td>DSI-D1+</td> <td>DSI-D1-</td> <td>DSI-CLK+</td> <td>DSI-CLK-</td> <td>DSI-D0+</td> <td>DSI-D0-</td> </tr> <tr> <td>DSWAP=1 PSWAP=1</td> <td>DSI-D1-</td> <td>DSI-D1+</td> <td>DSI-CLK-</td> <td>DSI-CLK+</td> <td>DSI-D0-</td> <td>DSI-D0+</td> </tr> </tbody> </table> Please connect to VSSI if not used.	Pin Name	HSSI_D0_P	HSSI_D0_N	HSSI_CLK_P	HSSI_CLK_N	HSSI_D1_P	HSSI_D1_N	DSWAP=0 PSWAP=0	DSI-D0+	DSI-D0-	DSI-CLK+	DSI-CLK-	DSI-D1+	DSI-D1-	DSWAP=0 PSWAP=1	DSI-D0-	DSI-D0+	DSI-CLK-	DSI-CLK+	DSI-D1-	DSI-D1+	DSWAP=1 PSWAP=0	DSI-D1+	DSI-D1-	DSI-CLK+	DSI-CLK-	DSI-D0+	DSI-D0-	DSWAP=1 PSWAP=1	DSI-D1-	DSI-D1+	DSI-CLK-	DSI-CLK+	DSI-D0-	DSI-D0+
Pin Name	HSSI_D0_P	HSSI_D0_N	HSSI_CLK_P	HSSI_CLK_N	HSSI_D1_P	HSSI_D1_N																															
DSWAP=0 PSWAP=0	DSI-D0+	DSI-D0-	DSI-CLK+	DSI-CLK-	DSI-D1+	DSI-D1-																															
DSWAP=0 PSWAP=1	DSI-D0-	DSI-D0+	DSI-CLK-	DSI-CLK+	DSI-D1-	DSI-D1+																															
DSWAP=1 PSWAP=0	DSI-D1+	DSI-D1-	DSI-CLK+	DSI-CLK-	DSI-D0+	DSI-D0-																															
DSWAP=1 PSWAP=1	DSI-D1-	DSI-D1+	DSI-CLK-	DSI-CLK+	DSI-D0-	DSI-D0+																															
Logic Pins																																					
Pin Name	I/O	Descriptions																																			

RESX	I	This signal will reset the device and must be applied to properly initialize the chip. Signal is active low. The input voltage range for RESX pin is related to DSTB_SEL and VSEL pins.					
		Input Voltage Level (DSTB_SEL="1")		VDDI=1.65~3.3V		VDDIL=1.1~1.3V	
				Min.	Max.	Min.	Max.
		VSEL = 1	Logic high level input voltage	0.7xVDDI	VDDI	1.155	1.95
			Logic low level input voltage	VSSI	0.3xVDDI	VSSI	0.585
		VSEL = 0	Logic high level input voltage	0.88	1.35	0.88	1.35
			Logic low level input voltage	VSSI	0.55	VSSI	0.55
		Input Voltage Level (DSTB_SEL="0")				Min. (v)	Max. (v)
		VDDI=1.65~3.3V	Logic High level input voltage		0.7xVDDI	VDDI	
			Logic Low level input voltage		VSSI	0.3xVDDI	
VDDI=1.1~1.3V	Logic High level input voltage		0.88	1.35			
	Logic Low level input voltage		VSSI	0.55			

TE_L	O	Tearing effect output pin to synchronize MCU to frame writing, activated by S/W command. When this pin is not activated, this pin is output low. Please open this pin if not used.
TE_R	O	Tearing effect output pin to synchronize MCU to frame writing, activated by S/W command. When this pin is not activated, this pin is output low. Please open this pin if not used.
RGBBP	I	Display data written path control in RGB interface. RGBBP="0", display data written to frame memory. RGBBP="1", display data written to line buffer (frame memory by pass mode) Please connect to VSSI if not used in other interfaces.

IM[3:0]	I	Interface type selection. The connections of IM[3:0] which not shown in table are invalid.		
		IM[3:0]	Display Data	Command
		0000	80-series 8-bit MPU I/F, D[7:0]	80-series 8-bit MPU I/F, D[7:0]
		0001	80-series 16-bit MPU I/F, D[15:0]	80-series 16-bit MPU I/F, D[15:0]
		0010	80-series 24-bit MPU I/F, D[23:0]	80-series 24-bit MPU I/F, D[23:0]
		0011	RGB I/F, D[23:0]	16-bit SPI (SCL rising edge trigger), SDI/SDO
		0100	RGB I/F, D[23:0]	I2C I/F, I2C_SDA
		0101	MIPI DSI,HSSI_D0_P/N, HSSI_D1_P/N	MIPI DSI,HSSI_D0_P/N, HSSI_D1_P/N
		1101	MIPI DSI,HSSI_D0_P/N, HSSI_D1_P/N	MIPI DSI,HSSI_D0_P/N,HSSI_D1_P/N (Video Mode)
		0110	MDDI,HSSI_D0_P/N, HSSI_D1_P/N	MDDI, HSSI_D0_P/N, HSSI_D1_P/N 16-bit SPI (SCL rising edge trigger), SDI/SDO
		1110	MDDI,HSSI_D0_P/N, HSSI_D1_P/N	MDDI, HSSI_D0_P/N, HSSI_D1_P/N 16-bit SPI (SCL falling edge trigger), SDI/SDO
		0111	MDDI,HSSI_D0_P/N, HSSI_D1_P/N	MDDI, HSSI_D0_P/N, HSSI_D1_P/N I2C I/F, I2C_SDA serial data
1011	RGB I/F, D[23:0]	16-bit SPI (SCL falling edge trigger), SDI/SDO		
I2C_SA	I	Select the I2C interface address from MPU. 0: 100_1100 1: 100_1101		

VSEL	I	Input pin to switch the I/O voltage. This VSEL function only apply for RESX, TE, LEDPWM, LEDON, KBBC pins. The VSEL dual IO function is valid when DSTB_SEL="1".					
		DSTB_SEL	VDDI	VSEL	DIOPWR	Output Voltage Level	
		0	1.65~3.3v or 1.1~1.3v	X	Off	TE	LEDON/LEDPWM
		1	1.65~3.3v	Low	1.2v	VOH=VDDI VOL=VSSI	VOH=VDDI or VDDA VOL=VSSI
1	1.1~1.3v	High	1.8v	VOH=1.2v VOL=VSSI	VOH=1.2 VOL=VSSI		
		Low	1.2v	VOH=VDDI or DIOPWR VOL=VSSI	VOH=VDDI or VDDA VOL=VSSI		
1	1.1~1.3v	High	1.8v	VOH=1.2v VOL=VSSI	VOH=1.2v VOL=VSSI		
		Low	1.2v	VOH=1.8v VOL=VSSI	VOH=1.8v VOL=VSSI		
The input voltage range for VSEL pin:							
Input Voltage Level					Min.	Max.	
Logic High level input voltage					0.88	VDDI	
Logic Low level input voltage					VSSI	0.55	
Please open these pins if not used.							
GPO[3:0]	O	General purpose output pins. The output voltage swing is VDDI to VSSI.					
VGSW[3:0]	I	Input pin to select the different application.					
EXB1T	I	Input pin to select the external DDVDH DC/DC voltage. 0: Use internal DC/DC for DDVDH 1: Use external DC/DC for DDVDH Please connect to VSSI if not used.					
NBWSEL	I	Input pin to select the voltage sequence of V0 ~ V255. 0: V(00h)>V(01h)>...>V(FEh)>V(FFh) (Normally White) 1: V(00h)<V(01h)<...<V(FEh)<V(FFh) (Normally Black)					
DSTB_SEL	I	Input pin to control DIOPWR regulator on/off.					
		DSTB_SEL	DIOPWR Regulator	VSEL Function			
		0	DIOPWR Off	Invalid			
1	DIOPWR On	Valid					
CABC and LABC Pins							
Pin Name	I/O	Descriptions					
LEDON	O	This pin is connect to the external LED driver. It is a LED driver control signal which is used for turning ON/OFF the LED backlight.					

LEDPWM	O	This pin is connect to the external LED driver. It is a PWM type control signal for brightness of the LED backlight. The width of LEDPWM signal is set from 256 values between 0% (Low) and 100% (High).
Power supply		
Pin Name	I/O	Descriptions
VDDB	DC/DC Power	Power supply for DC/DC converter VDDB, VDDA and VDDR should be the same input voltage level
VDDA	Analog Power	Power supply for analog system VDDB, VDDA and VDDR should be the same input voltage level
VDDR	Regulator Power	Power supply for regulator system VDDB, VDDA and VDDR should be the same input voltage level
VDD_DET	Detection Power	Connect to VDDB/VDDA/VDDR for detection.
VDDAM	MIPI Power	Power supply for MIPI/MDDI analog regulator system
VDDI	I/O Power	Power supply for interface system except MIPI/MDDI interface
DVDD	Digital Voltage	Regulator output for logic system power (1.5V typical) Connect a capacitor for stabilization.
DIOPWR	Dual I/O Voltage	Regulator output for dual I/O voltage system (1.2V/1.8V typical). Connect a capacitor for stabilization.
MVDDA	MIPI/MDDI Voltage	Regulator output for internal MIPI/MDDI analog system (1.5V typical) Connect a capacitor for stabilization. If not use MIPI/MDDI interface, please open this pin.
MVDDL	MIPI Voltage	Regulator output for internal MIPI low power system (1.2V typical) Connect a capacitor for stabilization. If not use MIPI interface, please open this pin
VSSB	DC/DC GND	System ground for DC/DC converter
VSSA	Analog GND	System ground for analog system
VSSR	Regulator GND	System ground for regulator system
VSSAM	MIPI GND	System ground for internal MIPI/MDDI analog system
VSSI	I/O GND	System ground for interface system except MIPI/MDDI interface

DVSS	Digital GND	System ground for internal digital system
AVSS	Source OP GND	System ground for source OP system
MTP_PWR	MTP Power	MTP programming power supply pin (7.4 to 7.6V and 7.5V typical) Must be left open or connected to DVSS in normal condition
Step-up Circuit		
Pin Name	I/O	Descriptions
AVDD (DDVDH)	O	Output voltage from step-up circuit 1, generated from VDDB. Connect a capacitor for stabilization.
AVEE (DDVDL)	O	Output voltage from step-up circuit 2, generated from VDDB. Connect a capacitor for stabilization.
VCL	O	Output voltage from step-up circuit 3, generated from VDDB. Connect a capacitor for stabilization.
VGH	O	Output voltage from step-up circuit 4. Connect a capacitor for stabilization.
VGLX	O	Output voltage from step-up circuit 5. Connect a capacitor for stabilization.
VGL	I	Substrate voltage for driver IC. Please connect VGL to VGLX.
C11P, C11N C12P, C12N C13P, C13N C14P, C14N	O	Capacitor connection pins for the step-up circuit which generate AVDD. Connect capacitor as requirement.
C21P, C21N C22P, C22N C23P, C23N C24P, C24N	O	Capacitor connection pins for the step-up circuit which generate AVEE. Connect capacitor as requirement.
C31P, C31N C32P, C32N	O	Capacitor connection pins for the step-up circuit which generate VCL. Connect capacitor as requirement.
C41P, C41N	O	Capacitor connection pins for the step-up circuit which generate VGH. Connect capacitor as requirement.
C51P, C51N	O	Capacitor connection pins for the step-up circuit which generate VGLX. Connect capacitor as requirement.
VRGH	O	Output voltage generated from AVDD. Connect a capacitor for stabilization.
VGL_REG	O	Output voltage generated from VGLX. LDO output used for panel voltage. Connect a capacitor for stabilization.

EXTP	O	PFM1 control output for DC/DC converter to generate AVDD. Connect to gate of external NMOS device.
EXTN	O	PFM2 control output for DC/DC converter to generate AVEE. Connect to gate of external PMOS device.
CSP	I	Current sensing input for PFM1 DC/DC converter (generate AVDD).
CSN	I	Current sensing input for PFM2 DC/DC converter (generate AVEE).
VREF_PWR	O	Regulator output for power voltage. Connect a capacitor for stabilization.
VREFCP	O	Reference voltage for internal voltage generating circuit. Connect capacitor for stabilization.
VGMP	O	Output voltage generated from AVDD. LDO output for positive gamma high voltage generator.
VGSP	O	Output voltage generated from AVDD. LDO output for positive gamma low voltage generator.
VGMN	O	Output voltage generated from AVEE. LDO output for negative gamma high voltage generator.
VGSN	O	Output voltage generated from AVEE. LDO output for negative gamma low voltage generator.

Output Pins

Pin Name	I/O	Descriptions
S1 ~S1440	O	Pixel electrode driving output.
GOUT1 ~ GOUT32	O	Gate control signals for panel. The swing voltage level is VGHO to VGLO
SDUM0 ~ 3	O	Dummy Source.
VGHO	O	High voltage level for gate control signals and gate circuit of panel.
VGLO	O	Low voltage level for gate control signals and gate circuit of panel.
LVGL	O	Low voltage level for gate circuit of panel.
VCOM	O	Regulator output for common voltage of panel. Connect a capacitor for stabilization.

Test and Dummy pins

Pin Name	I/O	Descriptions
----------	-----	--------------

PADA1 PADA2 PADA3 PADA4 PADB1 PADB2 PADB3 PADB4	I/O	These test pins for chip attachment detection. PADA1 to PADA4 are output pins and PADB1 to PADB4 are input pins. For normal operation: Connect PADA1 and PADB1 together by ITO trace. Connect PADA2 and PADB2 together by ITO trace. Connect PADA3 and PADB3 together by ITO trace. Connect PADA4 and PADB4 together by ITO trace.
CONTACT1A, CONTACT1B, CONTACT2A, CONTACT2B	I/O	Test pin, for test bonding quality, IC internal will connect CONTACT1A with CONTACT1B, CONTACT2A with CONTACT2B
AVSS_AVDD	I	Test pin, must be connected to AVSS
AVEE_AVSS	I	Test pin, must be connected to AVEE
VCL_VDDB	I	Test pin, must be connected to VCL
VCL_AVSS	I	Test pin, must be connected to VCL
VGMM_VGMP	I	Test pin, must be connected to VGMM
VGSN_VGSP	I	Test pin, must be connected to VGSN
KBBC	I	Test pin, not accessible to user.
TEST0~7	I/O	Test pin, not accessible to user. Must be left open.
OSC_TEST	I/O	Test pin, not accessible to user, Must left open
VDDI_OPT1~2	O	Use them to fix the electrical potentials of unused interface pins and fixed pins.
VSSI_OPT1	O	Use them to fix the electrical potentials of unused interface pins and fixed pins.
VSSIDUM0~106	O	These pins are dummy with VSSI potential (not have any function inside). Signal traces can't pass through on glass under these pads.

A-Si TFT LCD Drive Power Supply Specifications Table

No.	Item	Description	
1	TFT source driver	1440 pins (S1 ~ S1440)	
2	TFT gate driver	32 pins (GOUT1 ~ GOUT32)	
3	Liquid crystal drive output	S1~S1440	V0~V255 grayscales
		GOUT1 ~ GOUT32	VGH-VGL
		VCOM	DC VCOM
4	Input voltage	IOVCC	1.65V~3.30V
		VCI	2.30V~4.80V
5	Liquid crystal drive voltages	DDVDH	4.5V ~ 6.5V
		DDVDL	-4.5V ~ -6.5V
		VGH	8.0V ~ 18V
		VGL	-2V ~ -15V
		VGH-VGL	Avoid exceed 32v
6	Internal step-up circuits	DDVDH	VCIx1.5, VCIx1.66, VCIx2, VCIx2.5, VCIx3
		DDVDL	VCIx-1.5, VCIx-2, VCIx-2.5, VCIx-3
		VCL	VCIx-0.5, VCIx-1.0, VCIx-2.0
		VGH	(DDVDH+VCI), DDVDHx2, (DDVDH-DDVDL+VCI), (DDVDHx2-DDVDL)
		VGLX	(DDVDL+VCL), (DDVDL-DDVDH), (DDVDL+VCL-DDVDH), (DDVDLx2 - DDVDH)

5. Pad Diagram and Coordination

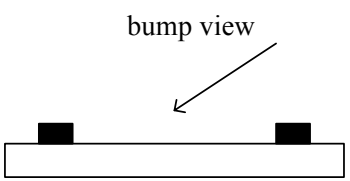
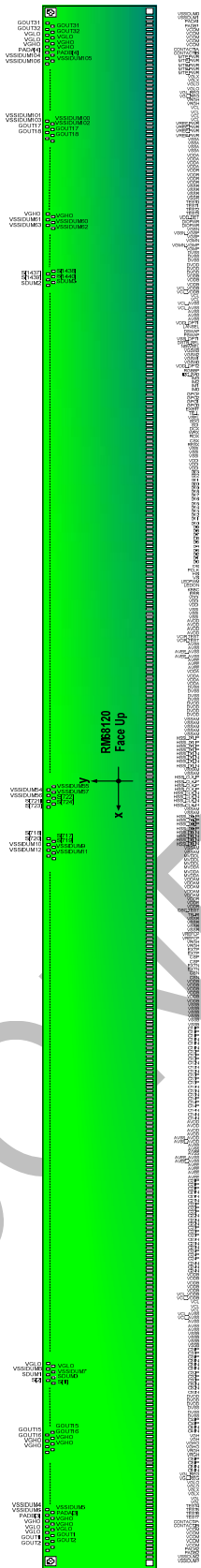

Alignment Mark:

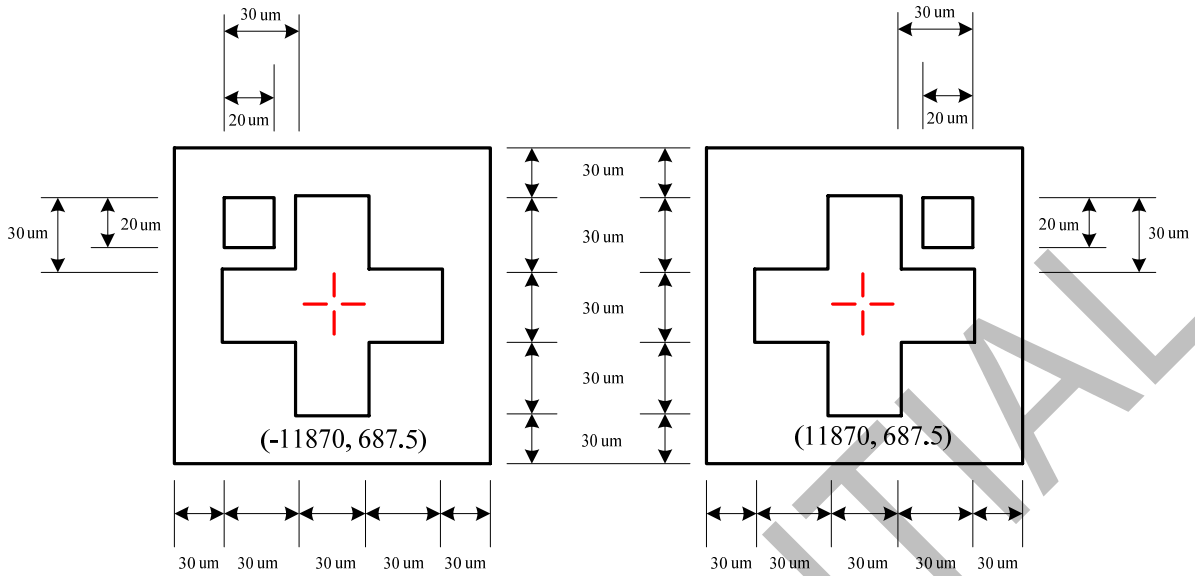

Bump Arrangement:

Input:

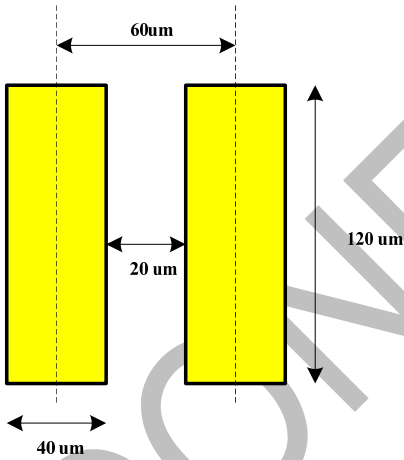

Input Pad

Output:

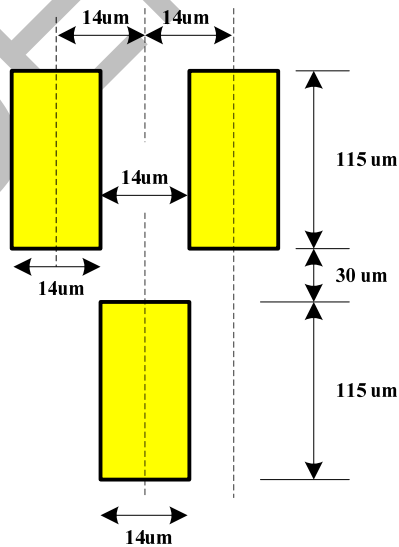

Output Pad

Coordinate:

Pad No.	Name	X-axis	Y-axis
1	VSSIDUM0	-11880	-702.5
2	VSSIDUM1	-11790	-702.5
3	PADA1	-11730	-702.5
4	PADB1	-11670	-702.5
5	VCOM	-11610	-702.5
6	VCOM	-11550	-702.5
7	VCOM	-11490	-702.5
8	VCOM	-11430	-702.5
9	VCOM	-11370	-702.5
10	CONTACT1A	-11310	-702.5
11	CONTACT1B	-11250	-702.5
12	MTP_PWR	-11190	-702.5
13	MTP_PWR	-11130	-702.5
14	MTP_PWR	-11070	-702.5
15	MTP_PWR	-11010	-702.5
16	MTP_PWR	-10950	-702.5
17	VGLX	-10890	-702.5
18	VGLX	-10830	-702.5
19	VGLO	-10770	-702.5
20	VGLO	-10710	-702.5
21	VGL_REG	-10650	-702.5
22	VGL_REG	-10590	-702.5
23	VRGH	-10530	-702.5
24	VRGH	-10470	-702.5
25	VCL	-10410	-702.5
26	VCL	-10350	-702.5
27	VCL	-10290	-702.5
28	VCL	-10230	-702.5
29	VREF_PWR	-10170	-702.5
30	VREF_PWR	-10110	-702.5
31	VREF_PWR	-10050	-702.5
32	VREF_PWR	-9990	-702.5
33	VSSA	-9930	-702.5
34	VSSA	-9870	-702.5
35	VSSA	-9810	-702.5
36	VSSA	-9750	-702.5
37	VDDA	-9690	-702.5
38	VDDA	-9630	-702.5
39	VDDA	-9570	-702.5
40	VDDA	-9510	-702.5
41	VDDR	-9450	-702.5
42	VDDR	-9390	-702.5
43	VDDR	-9330	-702.5
44	VDDR	-9270	-702.5
45	VSSR	-9210	-702.5
46	VSSR	-9150	-702.5
47	VSSR	-9090	-702.5
48	VSSR	-9030	-702.5
49	TEST0	-8970	-702.5
50	TEST1	-8910	-702.5
51	TEST2	-8850	-702.5
52	TEST3	-8790	-702.5
53	VDD_DET	-8730	-702.5
54	DIOPWR	-8670	-702.5

55	DIOPWR	-8610	-702.5
56	VGSN	-8550	-702.5
57	VGSN_VGSP	-8490	-702.5
58	VGSP	-8430	-702.5
59	VGMN	-8370	-702.5
60	VGMN_VGMP	-8310	-702.5
61	VGMP	-8250	-702.5
62	DVSS	-8190	-702.5
63	DVSS	-8130	-702.5
64	DVSS	-8070	-702.5
65	DVDD	-8010	-702.5
66	DVDD	-7950	-702.5
67	DVDD	-7890	-702.5
68	VDDDB	-7830	-702.5
69	VDDDB	-7770	-702.5
70	VDDDB	-7710	-702.5
71	VCL_VDDDB	-7650	-702.5
72	VCL_VDDDB	-7590	-702.5
73	VCL	-7530	-702.5
74	VCL	-7470	-702.5
75	VCL_AVSS	-7410	-702.5
76	VCL_AVSS	-7350	-702.5
77	AVSS	-7290	-702.5
78	AVSS	-7230	-702.5
79	AVSS	-7170	-702.5
80	VDDI_OPT1	-7110	-702.5
81	LANSEL	-7050	-702.5
82	DSWAP	-6990	-702.5
83	PSWAP	-6930	-702.5
84	VSSI_OPT1	-6870	-702.5
85	DSTB_SEL	-6810	-702.5
86	NBWSEL	-6750	-702.5
87	VGSW3	-6690	-702.5
88	VGSW2	-6630	-702.5
89	VGSW1	-6570	-702.5
90	VGSW0	-6510	-702.5
91	VDDI_OPT2	-6450	-702.5
92	RGBBP	-6390	-702.5
93	I2C_SA0	-6330	-702.5
94	IM3	-6270	-702.5
95	IM2	-6210	-702.5
96	IM1	-6150	-702.5
97	IM0	-6090	-702.5
98	GPO3	-6030	-702.5
99	GPO2	-5970	-702.5
100	GPO1	-5910	-702.5
101	GPO0	-5850	-702.5
102	EXB1T	-5790	-702.5
103	TE_L	-5730	-702.5
104	VSEL	-5670	-702.5
105	SDO	-5610	-702.5
106	SDI	-5550	-702.5
107	DCX	-5490	-702.5
108	WRX	-5430	-702.5
109	RDX	-5370	-702.5
110	CSX	-5310	-702.5
111	RESX	-5250	-702.5

112	VSSI	-5190	-702.5
113	VSSI	-5130	-702.5
114	VSSI	-5070	-702.5
115	VDDI	-5010	-702.5
116	VDDI	-4950	-702.5
117	VDDI	-4890	-702.5
118	D23	-4830	-702.5
119	D22	-4770	-702.5
120	D21	-4710	-702.5
121	D20	-4650	-702.5
122	D19	-4590	-702.5
123	D18	-4530	-702.5
124	D17	-4470	-702.5
125	D16	-4410	-702.5
126	D15	-4350	-702.5
127	D14	-4290	-702.5
128	D13	-4230	-702.5
129	D12	-4170	-702.5
130	D11	-4110	-702.5
131	D10	-4050	-702.5
132	D9	-3990	-702.5
133	D8	-3930	-702.5
134	D7	-3870	-702.5
135	D6	-3810	-702.5
136	D5	-3750	-702.5
137	D4	-3690	-702.5
138	D3	-3630	-702.5
139	D2	-3570	-702.5
140	D1	-3510	-702.5
141	D0	-3450	-702.5
142	DE	-3390	-702.5
143	PCLK	-3330	-702.5
144	HS	-3270	-702.5
145	VS	-3210	-702.5
146	LEDPWM	-3150	-702.5
147	LEDON	-3090	-702.5
148	KBBC	-3030	-702.5
149	ERR	-2970	-702.5
150	VDDI	-2910	-702.5
151	VDDI	-2850	-702.5
152	VDDI	-2790	-702.5
153	VSSI	-2730	-702.5
154	VSSI	-2670	-702.5
155	VSSI	-2610	-702.5
156	AVDD	-2550	-702.5
157	AVDD	-2490	-702.5
158	AVDD	-2430	-702.5
159	AVDD	-2370	-702.5
160	AVSS_AVDD	-2310	-702.5
161	AVSS_AVDD	-2250	-702.5
162	AVSS	-2190	-702.5
163	AVSS	-2130	-702.5
164	AVEE_AVSS	-2070	-702.5
165	AVEE_AVSS	-2010	-702.5
166	AVEE	-1950	-702.5
167	AVEE	-1890	-702.5
168	AVEE	-1830	-702.5

169	VDDA	-1770	-702.5
170	VDDA	-1710	-702.5
171	VDDA	-1650	-702.5
172	VDDA	-1590	-702.5
173	DVSS	-1530	-702.5
174	DVSS	-1470	-702.5
175	DVSS	-1410	-702.5
176	DVSS	-1350	-702.5
177	DVDD	-1290	-702.5
178	DVDD	-1230	-702.5
179	DVDD	-1170	-702.5
180	DVDD	-1110	-702.5
181	VSSAM	-1050	-702.5
182	VSSAM	-990	-702.5
183	VSSAM	-930	-702.5
184	VSSAM	-870	-702.5
185	VSSAM	-810	-702.5
186	HSSI_D1_P	-750	-702.5
187	HSSI_D1_P	-690	-702.5
188	HSSI_D1_P	-630	-702.5
189	HSSI_D1_P	-570	-702.5
190	HSSI_D1_N	-510	-702.5
191	HSSI_D1_N	-450	-702.5
192	HSSI_D1_N	-390	-702.5
193	HSSI_D1_N	-330	-702.5
194	VSSAM	-270	-702.5
195	VSSAM	-210	-702.5
196	HSSI_CLK_P	-150	-702.5
197	HSSI_CLK_P	-90	-702.5
198	HSSI_CLK_P	-30	-702.5
199	HSSI_CLK_P	30	-702.5
200	HSSI_CLK_N	90	-702.5
201	HSSI_CLK_N	150	-702.5
202	HSSI_CLK_N	210	-702.5
203	HSSI_CLK_N	270	-702.5
204	VSSAM	330	-702.5
205	VSSAM	390	-702.5
206	HSSI_D0_P	450	-702.5
207	HSSI_D0_P	510	-702.5
208	HSSI_D0_P	570	-702.5
209	HSSI_D0_P	630	-702.5
210	HSSI_D0_N	690	-702.5
211	HSSI_D0_N	750	-702.5
212	HSSI_D0_N	810	-702.5
213	HSSI_D0_N	870	-702.5
214	VSSAM	930	-702.5
215	VSSAM	990	-702.5
216	MVDDL	1050	-702.5
217	MVDDL	1110	-702.5
218	MVDDL	1170	-702.5
219	MVDDA	1230	-702.5
220	MVDDA	1290	-702.5
221	MVDDA	1350	-702.5
222	VDDAM	1410	-702.5
223	VDDAM	1470	-702.5
224	VDDAM	1530	-702.5
225	VDDAM	1590	-702.5

226	VDDAM	1650	-702.5
227	VDDR	1710	-702.5
228	VDDR	1770	-702.5
229	VDDR	1830	-702.5
230	OSC_TEST	1890	-702.5
231	TE_R	1950	-702.5
232	VSSR	2010	-702.5
233	VSSR	2070	-702.5
234	VSSR	2130	-702.5
235	VSSR	2190	-702.5
236	VREFCP	2250	-702.5
237	VREFCP	2310	-702.5
238	VRGH	2370	-702.5
239	VRGH	2430	-702.5
240	EXTP	2490	-702.5
241	EXTP	2550	-702.5
242	CSP	2610	-702.5
243	CSP	2670	-702.5
244	EXTN	2730	-702.5
245	EXTN	2790	-702.5
246	CSN	2850	-702.5
247	CSN	2910	-702.5
248	Vddb	2970	-702.5
249	Vddb	3030	-702.5
250	Vddb	3090	-702.5
251	Vddb	3150	-702.5
252	Vddb	3210	-702.5
253	Vddb	3270	-702.5
254	VSSB	3330	-702.5
255	VSSB	3390	-702.5
256	VSSB	3450	-702.5
257	VSSB	3510	-702.5
258	VSSB	3570	-702.5
259	VSSB	3630	-702.5
260	C11P	3690	-702.5
261	C11P	3750	-702.5
262	C11P	3810	-702.5
263	C11N	3870	-702.5
264	C11N	3930	-702.5
265	C11N	3990	-702.5
266	C12P	4050	-702.5
267	C12P	4110	-702.5
268	C12P	4170	-702.5
269	C12N	4230	-702.5
270	C12N	4290	-702.5
271	C12N	4350	-702.5
272	C13P	4410	-702.5
273	C13P	4470	-702.5
274	C13P	4530	-702.5
275	C13N	4590	-702.5
276	C13N	4650	-702.5
277	C13N	4710	-702.5
278	C14P	4770	-702.5
279	C14P	4830	-702.5
280	C14P	4890	-702.5
281	C14N	4950	-702.5
282	C14N	5010	-702.5

283	C14N	5070	-702.5
284	AVDD	5130	-702.5
285	AVDD	5190	-702.5
286	AVDD	5250	-702.5
287	AVDD	5310	-702.5
288	AVSS_AVDD	5370	-702.5
289	AVSS_AVDD	5430	-702.5
290	AVSS	5490	-702.5
291	AVSS	5550	-702.5
292	AVSS	5610	-702.5
293	AVEE_AVSS	5670	-702.5
294	AVEE_AVSS	5730	-702.5
295	AVEE	5790	-702.5
296	AVEE	5850	-702.5
297	AVEE	5910	-702.5
298	AVEE	5970	-702.5
299	C21P	6030	-702.5
300	C21P	6090	-702.5
301	C21P	6150	-702.5
302	C21N	6210	-702.5
303	C21N	6270	-702.5
304	C21N	6330	-702.5
305	C22P	6390	-702.5
306	C22P	6450	-702.5
307	C22P	6510	-702.5
308	C22N	6570	-702.5
309	C22N	6630	-702.5
310	C22N	6690	-702.5
311	C23P	6750	-702.5
312	C23P	6810	-702.5
313	C23P	6870	-702.5
314	C23N	6930	-702.5
315	C23N	6990	-702.5
316	C23N	7050	-702.5
317	C24P	7110	-702.5
318	C24P	7170	-702.5
319	C24P	7230	-702.5
320	C24N	7290	-702.5
321	C24N	7350	-702.5
322	C24N	7410	-702.5
323	Vddb	7470	-702.5
324	Vddb	7530	-702.5
325	Vddb	7590	-702.5
326	Vddb	7650	-702.5
327	Vddb	7710	-702.5
328	VCL_Vddb	7770	-702.5
329	VCL_Vddb	7830	-702.5
330	VCL	7890	-702.5
331	VCL	7950	-702.5
332	VCL	8010	-702.5
333	VCL_AVSS	8070	-702.5
334	VCL_AVSS	8130	-702.5
335	AVSS	8190	-702.5
336	AVSS	8250	-702.5
337	AVSS	8310	-702.5
338	VSSB	8370	-702.5
339	VSSB	8430	-702.5

340	VSSB	8490	-702.5
341	VSSB	8550	-702.5
342	C31P	8610	-702.5
343	C31P	8670	-702.5
344	C31P	8730	-702.5
345	C31N	8790	-702.5
346	C31N	8850	-702.5
347	C31N	8910	-702.5
348	C32P	8970	-702.5
349	C32P	9030	-702.5
350	C32P	9090	-702.5
351	C32N	9150	-702.5
352	C32N	9210	-702.5
353	C32N	9270	-702.5
354	DVDD	9330	-702.5
355	DVDD	9390	-702.5
356	DVDD	9450	-702.5
357	DVSS	9510	-702.5
358	DVSS	9570	-702.5
359	DVSS	9630	-702.5
360	C41P	9690	-702.5
361	C41P	9750	-702.5
362	C41N	9810	-702.5
363	C41N	9870	-702.5
364	VGH	9930	-702.5
365	VGH	9990	-702.5
366	VGHO	10050	-702.5
367	VGHO	10110	-702.5
368	VRGH	10170	-702.5
369	VRGH	10230	-702.5
370	C51P	10290	-702.5
371	C51P	10350	-702.5
372	C51N	10410	-702.5
373	C51N	10470	-702.5
374	VGL_REG	10530	-702.5
375	VGL_REG	10590	-702.5
376	VGLO	10650	-702.5
377	VGLO	10710	-702.5
378	VGLX	10770	-702.5
379	VGLX	10830	-702.5
380	VGL	10890	-702.5
381	VGL	10950	-702.5
382	TEST4	11010	-702.5
383	TEST5	11070	-702.5
384	TEST6	11130	-702.5
385	TEST7	11190	-702.5
386	CONTACT2A	11250	-702.5
387	CONTACT2B	11310	-702.5
388	VCOM	11370	-702.5
389	VCOM	11430	-702.5
390	VCOM	11490	-702.5
391	VCOM	11550	-702.5
392	VCOM	11610	-702.5
393	PADA2	11670	-702.5
394	PADB2	11730	-702.5
395	VSSIDUM2	11790	-702.5
396	VSSIDUM3	11880	-702.5

397	VSSIDUM4	11760	705
398	VSSIDUM5	11732	560
399	VSSIDUM6	11718	705
400	PADA3	11704	560
401	PADB3	11690	705
402	VGHO	11676	560
403	VGHO	11662	705
404	VGHO	11648	560
405	VGLO	11634	705
406	VGLO	11620	560
407	VGLO	11606	705
408	GOUT1	11592	560
409	GOUT1	11578	705
410	GOUT2	11564	560
411	GOUT2	11550	705
412	LVGL	11536	560
413	LVGL	11522	705
414	LVGL	11508	560
415	VRGH	11494	705
416	VRGH	11480	560
417	VRGH	11466	705
418	VGLO	11452	560
419	VGLO	11438	705
420	VGLO	11424	560
421	GOUT3	11410	705
422	GOUT3	11396	560
423	GOUT4	11382	705
424	GOUT4	11368	560
425	GOUT5	11354	705
426	GOUT5	11340	560
427	GOUT6	11326	705
428	GOUT6	11312	560
429	GOUT7	11298	705
430	GOUT7	11284	560
431	GOUT8	11270	705
432	GOUT8	11256	560
433	GOUT9	11242	705
434	GOUT9	11228	560
435	GOUT10	11214	705
436	GOUT10	11200	560
437	GOUT11	11186	705
438	GOUT11	11172	560
439	GOUT12	11158	705
440	GOUT12	11144	560
441	GOUT13	11130	705
442	GOUT13	11116	560
443	GOUT14	11102	705
444	GOUT14	11088	560
445	GOUT15	11074	705
446	GOUT15	11060	560
447	GOUT16	11046	705
448	GOUT16	11032	560
449	VGHO	11018	705
450	VGHO	11004	560
451	VGHO	10990	705
452	VGHO	10976	560
453	VGHO	10962	705

454	VGHO	10948	560
455	VGHO	10934	705
456	VGHO	10920	560
457	VGLO	10906	705
458	VGLO	10892	560
459	VGLO	10878	705
460	VGLO	10864	560
461	VGLO	10850	705
462	VGLO	10836	560
463	VGLO	10822	705
464	VGLO	10808	560
465	VGLO	10794	705
466	VSSIDUM7	10780	560
467	VSSIDUM8	10766	705
468	SDUM0	10752	560
469	SDUM1	10738	705
470	S1	10724	560
471	S2	10710	705
472	S3	10696	560
473	S4	10682	705
474	S5	10668	560
475	S6	10654	705
476	S7	10640	560
477	S8	10626	705
478	S9	10612	560
479	S10	10598	705
480	S11	10584	560
481	S12	10570	705
482	S13	10556	560
483	S14	10542	705
484	S15	10528	560
485	S16	10514	705
486	S17	10500	560
487	S18	10486	705
488	S19	10472	560
489	S20	10458	705
490	S21	10444	560
491	S22	10430	705
492	S23	10416	560
493	S24	10402	705
494	S25	10388	560
495	S26	10374	705
496	S27	10360	560
497	S28	10346	705
498	S29	10332	560
499	S30	10318	705
500	S31	10304	560
501	S32	10290	705
502	S33	10276	560
503	S34	10262	705
504	S35	10248	560
505	S36	10234	705
506	S37	10220	560
507	S38	10206	705
508	S39	10192	560
509	S40	10178	705
510	S41	10164	560

511	S42	10150	705
512	S43	10136	560
513	S44	10122	705
514	S45	10108	560
515	S46	10094	705
516	S47	10080	560
517	S48	10066	705
518	S49	10052	560
519	S50	10038	705
520	S51	10024	560
521	S52	10010	705
522	S53	9996	560
523	S54	9982	705
524	S55	9968	560
525	S56	9954	705
526	S57	9940	560
527	S58	9926	705
528	S59	9912	560
529	S60	9898	705
530	S61	9884	560
531	S62	9870	705
532	S63	9856	560
533	S64	9842	705
534	S65	9828	560
535	S66	9814	705
536	S67	9800	560
537	S68	9786	705
538	S69	9772	560
539	S70	9758	705
540	S71	9744	560
541	S72	9730	705
542	S73	9716	560
543	S74	9702	705
544	S75	9688	560
545	S76	9674	705
546	S77	9660	560
547	S78	9646	705
548	S79	9632	560
549	S80	9618	705
550	S81	9604	560
551	S82	9590	705
552	S83	9576	560
553	S84	9562	705
554	S85	9548	560
555	S86	9534	705
556	S87	9520	560
557	S88	9506	705
558	S89	9492	560
559	S90	9478	705
560	S91	9464	560
561	S92	9450	705
562	S93	9436	560
563	S94	9422	705
564	S95	9408	560
565	S96	9394	705
566	S97	9380	560
567	S98	9366	705

568	S99	9352	560
569	S100	9338	705
570	S101	9324	560
571	S102	9310	705
572	S103	9296	560
573	S104	9282	705
574	S105	9268	560
575	S106	9254	705
576	S107	9240	560
577	S108	9226	705
578	S109	9212	560
579	S110	9198	705
580	S111	9184	560
581	S112	9170	705
582	S113	9156	560
583	S114	9142	705
584	S115	9128	560
585	S116	9114	705
586	S117	9100	560
587	S118	9086	705
588	S119	9072	560
589	S120	9058	705
590	S121	9044	560
591	S122	9030	705
592	S123	9016	560
593	S124	9002	705
594	S125	8988	560
595	S126	8974	705
596	S127	8960	560
597	S128	8946	705
598	S129	8932	560
599	S130	8918	705
600	S131	8904	560
601	S132	8890	705
602	S133	8876	560
603	S134	8862	705
604	S135	8848	560
605	S136	8834	705
606	S137	8820	560
607	S138	8806	705
608	S139	8792	560
609	S140	8778	705
610	S141	8764	560
611	S142	8750	705
612	S143	8736	560
613	S144	8722	705
614	S145	8708	560
615	S146	8694	705
616	S147	8680	560
617	S148	8666	705
618	S149	8652	560
619	S150	8638	705
620	S151	8624	560
621	S152	8610	705
622	S153	8596	560
623	S154	8582	705
624	S155	8568	560

625	S156	8554	705
626	S157	8540	560
627	S158	8526	705
628	S159	8512	560
629	S160	8498	705
630	S161	8484	560
631	S162	8470	705
632	S163	8456	560
633	S164	8442	705
634	S165	8428	560
635	S166	8414	705
636	S167	8400	560
637	S168	8386	705
638	S169	8372	560
639	S170	8358	705
640	S171	8344	560
641	S172	8330	705
642	S173	8316	560
643	S174	8302	705
644	S175	8288	560
645	S176	8274	705
646	S177	8260	560
647	S178	8246	705
648	S179	8232	560
649	S180	8218	705
650	S181	8204	560
651	S182	8190	705
652	S183	8176	560
653	S184	8162	705
654	S185	8148	560
655	S186	8134	705
656	S187	8120	560
657	S188	8106	705
658	S189	8092	560
659	S190	8078	705
660	S191	8064	560
661	S192	8050	705
662	S193	8036	560
663	S194	8022	705
664	S195	8008	560
665	S196	7994	705
666	S197	7980	560
667	S198	7966	705
668	S199	7952	560
669	S200	7938	705
670	S201	7924	560
671	S202	7910	705
672	S203	7896	560
673	S204	7882	705
674	S205	7868	560
675	S206	7854	705
676	S207	7840	560
677	S208	7826	705
678	S209	7812	560
679	S210	7798	705
680	S211	7784	560
681	S212	7770	705

682	S213	7756	560
683	S214	7742	705
684	S215	7728	560
685	S216	7714	705
686	S217	7700	560
687	S218	7686	705
688	S219	7672	560
689	S220	7658	705
690	S221	7644	560
691	S222	7630	705
692	S223	7616	560
693	S224	7602	705
694	S225	7588	560
695	S226	7574	705
696	S227	7560	560
697	S228	7546	705
698	S229	7532	560
699	S230	7518	705
700	S231	7504	560
701	S232	7490	705
702	S233	7476	560
703	S234	7462	705
704	S235	7448	560
705	S236	7434	705
706	S237	7420	560
707	S238	7406	705
708	S239	7392	560
709	S240	7378	705
710	S241	7364	560
711	S242	7350	705
712	S243	7336	560
713	S244	7322	705
714	S245	7308	560
715	S246	7294	705
716	S247	7280	560
717	S248	7266	705
718	S249	7252	560
719	S250	7238	705
720	S251	7224	560
721	S252	7210	705
722	S253	7196	560
723	S254	7182	705
724	S255	7168	560
725	S256	7154	705
726	S257	7140	560
727	S258	7126	705
728	S259	7112	560
729	S260	7098	705
730	S261	7084	560
731	S262	7070	705
732	S263	7056	560
733	S264	7042	705
734	S265	7028	560
735	S266	7014	705
736	S267	7000	560
737	S268	6986	705
738	S269	6972	560

739	S270	6958	705
740	S271	6944	560
741	S272	6930	705
742	S273	6916	560
743	S274	6902	705
744	S275	6888	560
745	S276	6874	705
746	S277	6860	560
747	S278	6846	705
748	S279	6832	560
749	S280	6818	705
750	S281	6804	560
751	S282	6790	705
752	S283	6776	560
753	S284	6762	705
754	S285	6748	560
755	S286	6734	705
756	S287	6720	560
757	S288	6706	705
758	S289	6692	560
759	S290	6678	705
760	S291	6664	560
761	S292	6650	705
762	S293	6636	560
763	S294	6622	705
764	S295	6608	560
765	S296	6594	705
766	S297	6580	560
767	S298	6566	705
768	S299	6552	560
769	S300	6538	705
770	S301	6524	560
771	S302	6510	705
772	S303	6496	560
773	S304	6482	705
774	S305	6468	560
775	S306	6454	705
776	S307	6440	560
777	S308	6426	705
778	S309	6412	560
779	S310	6398	705
780	S311	6384	560
781	S312	6370	705
782	S313	6356	560
783	S314	6342	705
784	S315	6328	560
785	S316	6314	705
786	S317	6300	560
787	S318	6286	705
788	S319	6272	560
789	S320	6258	705
790	S321	6244	560
791	S322	6230	705
792	S323	6216	560
793	S324	6202	705
794	S325	6188	560
795	S326	6174	705

796	S327	6160	560
797	S328	6146	705
798	S329	6132	560
799	S330	6118	705
800	S331	6104	560
801	S332	6090	705
802	S333	6076	560
803	S334	6062	705
804	S335	6048	560
805	S336	6034	705
806	S337	6020	560
807	S338	6006	705
808	S339	5992	560
809	S340	5978	705
810	S341	5964	560
811	S342	5950	705
812	S343	5936	560
813	S344	5922	705
814	S345	5908	560
815	S346	5894	705
816	S347	5880	560
817	S348	5866	705
818	S349	5852	560
819	S350	5838	705
820	S351	5824	560
821	S352	5810	705
822	S353	5796	560
823	S354	5782	705
824	S355	5768	560
825	S356	5754	705
826	S357	5740	560
827	S358	5726	705
828	S359	5712	560
829	S360	5698	705
830	S361	5684	560
831	S362	5670	705
832	S363	5656	560
833	S364	5642	705
834	S365	5628	560
835	S366	5614	705
836	S367	5600	560
837	S368	5586	705
838	S369	5572	560
839	S370	5558	705
840	S371	5544	560
841	S372	5530	705
842	S373	5516	560
843	S374	5502	705
844	S375	5488	560
845	S376	5474	705
846	S377	5460	560
847	S378	5446	705
848	S379	5432	560
849	S380	5418	705
850	S381	5404	560
851	S382	5390	705
852	S383	5376	560

853	S384	5362	705
854	S385	5348	560
855	S386	5334	705
856	S387	5320	560
857	S388	5306	705
858	S389	5292	560
859	S390	5278	705
860	S391	5264	560
861	S392	5250	705
862	S393	5236	560
863	S394	5222	705
864	S395	5208	560
865	S396	5194	705
866	S397	5180	560
867	S398	5166	705
868	S399	5152	560
869	S400	5138	705
870	S401	5124	560
871	S402	5110	705
872	S403	5096	560
873	S404	5082	705
874	S405	5068	560
875	S406	5054	705
876	S407	5040	560
877	S408	5026	705
878	S409	5012	560
879	S410	4998	705
880	S411	4984	560
881	S412	4970	705
882	S413	4956	560
883	S414	4942	705
884	S415	4928	560
885	S416	4914	705
886	S417	4900	560
887	S418	4886	705
888	S419	4872	560
889	S420	4858	705
890	S421	4844	560
891	S422	4830	705
892	S423	4816	560
893	S424	4802	705
894	S425	4788	560
895	S426	4774	705
896	S427	4760	560
897	S428	4746	705
898	S429	4732	560
899	S430	4718	705
900	S431	4704	560
901	S432	4690	705
902	S433	4676	560
903	S434	4662	705
904	S435	4648	560
905	S436	4634	705
906	S437	4620	560
907	S438	4606	705
908	S439	4592	560
909	S440	4578	705

910	S441	4564	560
911	S442	4550	705
912	S443	4536	560
913	S444	4522	705
914	S445	4508	560
915	S446	4494	705
916	S447	4480	560
917	S448	4466	705
918	S449	4452	560
919	S450	4438	705
920	S451	4424	560
921	S452	4410	705
922	S453	4396	560
923	S454	4382	705
924	S455	4368	560
925	S456	4354	705
926	S457	4340	560
927	S458	4326	705
928	S459	4312	560
929	S460	4298	705
930	S461	4284	560
931	S462	4270	705
932	S463	4256	560
933	S464	4242	705
934	S465	4228	560
935	S466	4214	705
936	S467	4200	560
937	S468	4186	705
938	S469	4172	560
939	S470	4158	705
940	S471	4144	560
941	S472	4130	705
942	S473	4116	560
943	S474	4102	705
944	S475	4088	560
945	S476	4074	705
946	S477	4060	560
947	S478	4046	705
948	S479	4032	560
949	S480	4018	705
950	S481	4004	560
951	S482	3990	705
952	S483	3976	560
953	S484	3962	705
954	S485	3948	560
955	S486	3934	705
956	S487	3920	560
957	S488	3906	705
958	S489	3892	560
959	S490	3878	705
960	S491	3864	560
961	S492	3850	705
962	S493	3836	560
963	S494	3822	705
964	S495	3808	560
965	S496	3794	705
966	S497	3780	560

967	S498	3766	705
968	S499	3752	560
969	S500	3738	705
970	S501	3724	560
971	S502	3710	705
972	S503	3696	560
973	S504	3682	705
974	S505	3668	560
975	S506	3654	705
976	S507	3640	560
977	S508	3626	705
978	S509	3612	560
979	S510	3598	705
980	S511	3584	560
981	S512	3570	705
982	S513	3556	560
983	S514	3542	705
984	S515	3528	560
985	S516	3514	705
986	S517	3500	560
987	S518	3486	705
988	S519	3472	560
989	S520	3458	705
990	S521	3444	560
991	S522	3430	705
992	S523	3416	560
993	S524	3402	705
994	S525	3388	560
995	S526	3374	705
996	S527	3360	560
997	S528	3346	705
998	S529	3332	560
999	S530	3318	705
1000	S531	3304	560
1001	S532	3290	705
1002	S533	3276	560
1003	S534	3262	705
1004	S535	3248	560
1005	S536	3234	705
1006	S537	3220	560
1007	S538	3206	705
1008	S539	3192	560
1009	S540	3178	705
1010	S541	3164	560
1011	S542	3150	705
1012	S543	3136	560
1013	S544	3122	705
1014	S545	3108	560
1015	S546	3094	705
1016	S547	3080	560
1017	S548	3066	705
1018	S549	3052	560
1019	S550	3038	705
1020	S551	3024	560
1021	S552	3010	705
1022	S553	2996	560
1023	S554	2982	705

1024	S555	2968	560
1025	S556	2954	705
1026	S557	2940	560
1027	S558	2926	705
1028	S559	2912	560
1029	S560	2898	705
1030	S561	2884	560
1031	S562	2870	705
1032	S563	2856	560
1033	S564	2842	705
1034	S565	2828	560
1035	S566	2814	705
1036	S567	2800	560
1037	S568	2786	705
1038	S569	2772	560
1039	S570	2758	705
1040	S571	2744	560
1041	S572	2730	705
1042	S573	2716	560
1043	S574	2702	705
1044	S575	2688	560
1045	S576	2674	705
1046	S577	2660	560
1047	S578	2646	705
1048	S579	2632	560
1049	S580	2618	705
1050	S581	2604	560
1051	S582	2590	705
1052	S583	2576	560
1053	S584	2562	705
1054	S585	2548	560
1055	S586	2534	705
1056	S587	2520	560
1057	S588	2506	705
1058	S589	2492	560
1059	S590	2478	705
1060	S591	2464	560
1061	S592	2450	705
1062	S593	2436	560
1063	S594	2422	705
1064	S595	2408	560
1065	S596	2394	705
1066	S597	2380	560
1067	S598	2366	705
1068	S599	2352	560
1069	S600	2338	705
1070	S601	2324	560
1071	S602	2310	705
1072	S603	2296	560
1073	S604	2282	705
1074	S605	2268	560
1075	S606	2254	705
1076	S607	2240	560
1077	S608	2226	705
1078	S609	2212	560
1079	S610	2198	705
1080	S611	2184	560

1081	S612	2170	705
1082	S613	2156	560
1083	S614	2142	705
1084	S615	2128	560
1085	S616	2114	705
1086	S617	2100	560
1087	S618	2086	705
1088	S619	2072	560
1089	S620	2058	705
1090	S621	2044	560
1091	S622	2030	705
1092	S623	2016	560
1093	S624	2002	705
1094	S625	1988	560
1095	S626	1974	705
1096	S627	1960	560
1097	S628	1946	705
1098	S629	1932	560
1099	S630	1918	705
1100	S631	1904	560
1101	S632	1890	705
1102	S633	1876	560
1103	S634	1862	705
1104	S635	1848	560
1105	S636	1834	705
1106	S637	1820	560
1107	S638	1806	705
1108	S639	1792	560
1109	S640	1778	705
1110	S641	1764	560
1111	S642	1750	705
1112	S643	1736	560
1113	S644	1722	705
1114	S645	1708	560
1115	S646	1694	705
1116	S647	1680	560
1117	S648	1666	705
1118	S649	1652	560
1119	S650	1638	705
1120	S651	1624	560
1121	S652	1610	705
1122	S653	1596	560
1123	S654	1582	705
1124	S655	1568	560
1125	S656	1554	705
1126	S657	1540	560
1127	S658	1526	705
1128	S659	1512	560
1129	S660	1498	705
1130	S661	1484	560
1131	S662	1470	705
1132	S663	1456	560
1133	S664	1442	705
1134	S665	1428	560
1135	S666	1414	705
1136	S667	1400	560
1137	S668	1386	705

1138	S669	1372	560
1139	S670	1358	705
1140	S671	1344	560
1141	S672	1330	705
1142	S673	1316	560
1143	S674	1302	705
1144	S675	1288	560
1145	S676	1274	705
1146	S677	1260	560
1147	S678	1246	705
1148	S679	1232	560
1149	S680	1218	705
1150	S681	1204	560
1151	S682	1190	705
1152	S683	1176	560
1153	S684	1162	705
1154	S685	1148	560
1155	S686	1134	705
1156	S687	1120	560
1157	S688	1106	705
1158	S689	1092	560
1159	S690	1078	705
1160	S691	1064	560
1161	S692	1050	705
1162	S693	1036	560
1163	S694	1022	705
1164	S695	1008	560
1165	S696	994	705
1166	S697	980	560
1167	S698	966	705
1168	S699	952	560
1169	S700	938	705
1170	S701	924	560
1171	S702	910	705
1172	S703	896	560
1173	S704	882	705
1174	S705	868	560
1175	S706	854	705
1176	S707	840	560
1177	S708	826	705
1178	S709	812	560
1179	S710	798	705
1180	S711	784	560
1181	S712	770	705
1182	S713	756	560
1183	S714	742	705
1184	S715	728	560
1185	S716	714	705
1186	S717	700	560
1187	S718	686	705
1188	S719	672	560
1189	S720	658	705
1190	VSSIDUM9	644	560
1191	VSSIDUM10	630	705
1192	VSSIDUM11	616	560
1193	VSSIDUM12	602	705
1194	VSSIDUM13	588	560

1195	VSSIDUM14	574	705
1196	VSSIDUM15	560	560
1197	VSSIDUM16	546	705
1198	VSSIDUM17	532	560
1199	VSSIDUM18	518	705
1200	VSSIDUM19	504	560
1201	VSSIDUM20	490	705
1202	VSSIDUM21	476	560
1203	VSSIDUM22	462	705
1204	VSSIDUM23	448	560
1205	VSSIDUM24	434	705
1206	VSSIDUM25	420	560
1207	VSSIDUM26	406	705
1208	VSSIDUM27	392	560
1209	VSSIDUM28	378	705
1210	VSSIDUM29	364	560
1211	VSSIDUM30	350	705
1212	VSSIDUM31	336	560
1213	VSSIDUM32	322	705
1214	VSSIDUM33	308	560
1215	VSSIDUM34	294	705
1216	VSSIDUM35	280	560
1217	VSSIDUM36	266	705
1218	VSSIDUM37	252	560
1219	VSSIDUM38	238	705
1220	VSSIDUM39	224	560
1221	VSSIDUM40	210	705
1222	VSSIDUM41	196	560
1223	VSSIDUM42	182	705
1224	VSSIDUM43	168	560
1225	VSSIDUM44	154	705
1226	VSSIDUM45	140	560
1227	VSSIDUM46	126	705
1228	VSSIDUM47	112	560
1229	VSSIDUM48	98	705
1230	VSSIDUM49	84	560
1231	VSSIDUM50	70	705
1232	VSSIDUM51	56	560
1233	VSSIDUM52	42	705
1234	VSSIDUM53	28	560
1235	VSSIDUM54	14	705
1236	VSSIDUM55	0	560
1237	VSSIDUM56	-14	705
1238	VSSIDUM57	-28	560
1239	S721	-42	705
1240	S722	-56	560
1241	S723	-70	705
1242	S724	-84	560
1243	S725	-98	705
1244	S726	-112	560
1245	S727	-126	705
1246	S728	-140	560
1247	S729	-154	705
1248	S730	-168	560
1249	S731	-182	705
1250	S732	-196	560
1251	S733	-210	705

1252	S734	-224	560
1253	S735	-238	705
1254	S736	-252	560
1255	S737	-266	705
1256	S738	-280	560
1257	S739	-294	705
1258	S740	-308	560
1259	S741	-322	705
1260	S742	-336	560
1261	S743	-350	705
1262	S744	-364	560
1263	S745	-378	705
1264	S746	-392	560
1265	S747	-406	705
1266	S748	-420	560
1267	S749	-434	705
1268	S750	-448	560
1269	S751	-462	705
1270	S752	-476	560
1271	S753	-490	705
1272	S754	-504	560
1273	S755	-518	705
1274	S756	-532	560
1275	S757	-546	705
1276	S758	-560	560
1277	S759	-574	705
1278	S760	-588	560
1279	S761	-602	705
1280	S762	-616	560
1281	S763	-630	705
1282	S764	-644	560
1283	S765	-658	705
1284	S766	-672	560
1285	S767	-686	705
1286	S768	-700	560
1287	S769	-714	705
1288	S770	-728	560
1289	S771	-742	705
1290	S772	-756	560
1291	S773	-770	705
1292	S774	-784	560
1293	S775	-798	705
1294	S776	-812	560
1295	S777	-826	705
1296	S778	-840	560
1297	S779	-854	705
1298	S780	-868	560
1299	S781	-882	705
1300	S782	-896	560
1301	S783	-910	705
1302	S784	-924	560
1303	S785	-938	705
1304	S786	-952	560
1305	S787	-966	705
1306	S788	-980	560
1307	S789	-994	705
1308	S790	-1008	560

1309	S791	-1022	705
1310	S792	-1036	560
1311	S793	-1050	705
1312	S794	-1064	560
1313	S795	-1078	705
1314	S796	-1092	560
1315	S797	-1106	705
1316	S798	-1120	560
1317	S799	-1134	705
1318	S800	-1148	560
1319	S801	-1162	705
1320	S802	-1176	560
1321	S803	-1190	705
1322	S804	-1204	560
1323	S805	-1218	705
1324	S806	-1232	560
1325	S807	-1246	705
1326	S808	-1260	560
1327	S809	-1274	705
1328	S810	-1288	560
1329	S811	-1302	705
1330	S812	-1316	560
1331	S813	-1330	705
1332	S814	-1344	560
1333	S815	-1358	705
1334	S816	-1372	560
1335	S817	-1386	705
1336	S818	-1400	560
1337	S819	-1414	705
1338	S820	-1428	560
1339	S821	-1442	705
1340	S822	-1456	560
1341	S823	-1470	705
1342	S824	-1484	560
1343	S825	-1498	705
1344	S826	-1512	560
1345	S827	-1526	705
1346	S828	-1540	560
1347	S829	-1554	705
1348	S830	-1568	560
1349	S831	-1582	705
1350	S832	-1596	560
1351	S833	-1610	705
1352	S834	-1624	560
1353	S835	-1638	705
1354	S836	-1652	560
1355	S837	-1666	705
1356	S838	-1680	560
1357	S839	-1694	705
1358	S840	-1708	560
1359	S841	-1722	705
1360	S842	-1736	560
1361	S843	-1750	705
1362	S844	-1764	560
1363	S845	-1778	705
1364	S846	-1792	560
1365	S847	-1806	705

1366	S848	-1820	560
1367	S849	-1834	705
1368	S850	-1848	560
1369	S851	-1862	705
1370	S852	-1876	560
1371	S853	-1890	705
1372	S854	-1904	560
1373	S855	-1918	705
1374	S856	-1932	560
1375	S857	-1946	705
1376	S858	-1960	560
1377	S859	-1974	705
1378	S860	-1988	560
1379	S861	-2002	705
1380	S862	-2016	560
1381	S863	-2030	705
1382	S864	-2044	560
1383	S865	-2058	705
1384	S866	-2072	560
1385	S867	-2086	705
1386	S868	-2100	560
1387	S869	-2114	705
1388	S870	-2128	560
1389	S871	-2142	705
1390	S872	-2156	560
1391	S873	-2170	705
1392	S874	-2184	560
1393	S875	-2198	705
1394	S876	-2212	560
1395	S877	-2226	705
1396	S878	-2240	560
1397	S879	-2254	705
1398	S880	-2268	560
1399	S881	-2282	705
1400	S882	-2296	560
1401	S883	-2310	705
1402	S884	-2324	560
1403	S885	-2338	705
1404	S886	-2352	560
1405	S887	-2366	705
1406	S888	-2380	560
1407	S889	-2394	705
1408	S890	-2408	560
1409	S891	-2422	705
1410	S892	-2436	560
1411	S893	-2450	705
1412	S894	-2464	560
1413	S895	-2478	705
1414	S896	-2492	560
1415	S897	-2506	705
1416	S898	-2520	560
1417	S899	-2534	705
1418	S900	-2548	560
1419	S901	-2562	705
1420	S902	-2576	560
1421	S903	-2590	705
1422	S904	-2604	560

1423	S905	-2618	705
1424	S906	-2632	560
1425	S907	-2646	705
1426	S908	-2660	560
1427	S909	-2674	705
1428	S910	-2688	560
1429	S911	-2702	705
1430	S912	-2716	560
1431	S913	-2730	705
1432	S914	-2744	560
1433	S915	-2758	705
1434	S916	-2772	560
1435	S917	-2786	705
1436	S918	-2800	560
1437	S919	-2814	705
1438	S920	-2828	560
1439	S921	-2842	705
1440	S922	-2856	560
1441	S923	-2870	705
1442	S924	-2884	560
1443	S925	-2898	705
1444	S926	-2912	560
1445	S927	-2926	705
1446	S928	-2940	560
1447	S929	-2954	705
1448	S930	-2968	560
1449	S931	-2982	705
1450	S932	-2996	560
1451	S933	-3010	705
1452	S934	-3024	560
1453	S935	-3038	705
1454	S936	-3052	560
1455	S937	-3066	705
1456	S938	-3080	560
1457	S939	-3094	705
1458	S940	-3108	560
1459	S941	-3122	705
1460	S942	-3136	560
1461	S943	-3150	705
1462	S944	-3164	560
1463	S945	-3178	705
1464	S946	-3192	560
1465	S947	-3206	705
1466	S948	-3220	560
1467	S949	-3234	705
1468	S950	-3248	560
1469	S951	-3262	705
1470	S952	-3276	560
1471	S953	-3290	705
1472	S954	-3304	560
1473	S955	-3318	705
1474	S956	-3332	560
1475	S957	-3346	705
1476	S958	-3360	560
1477	S959	-3374	705
1478	S960	-3388	560
1479	S961	-3402	705

1480	S962	-3416	560
1481	S963	-3430	705
1482	S964	-3444	560
1483	S965	-3458	705
1484	S966	-3472	560
1485	S967	-3486	705
1486	S968	-3500	560
1487	S969	-3514	705
1488	S970	-3528	560
1489	S971	-3542	705
1490	S972	-3556	560
1491	S973	-3570	705
1492	S974	-3584	560
1493	S975	-3598	705
1494	S976	-3612	560
1495	S977	-3626	705
1496	S978	-3640	560
1497	S979	-3654	705
1498	S980	-3668	560
1499	S981	-3682	705
1500	S982	-3696	560
1501	S983	-3710	705
1502	S984	-3724	560
1503	S985	-3738	705
1504	S986	-3752	560
1505	S987	-3766	705
1506	S988	-3780	560
1507	S989	-3794	705
1508	S990	-3808	560
1509	S991	-3822	705
1510	S992	-3836	560
1511	S993	-3850	705
1512	S994	-3864	560
1513	S995	-3878	705
1514	S996	-3892	560
1515	S997	-3906	705
1516	S998	-3920	560
1517	S999	-3934	705
1518	S1000	-3948	560
1519	S1001	-3962	705
1520	S1002	-3976	560
1521	S1003	-3990	705
1522	S1004	-4004	560
1523	S1005	-4018	705
1524	S1006	-4032	560
1525	S1007	-4046	705
1526	S1008	-4060	560
1527	S1009	-4074	705
1528	S1010	-4088	560
1529	S1011	-4102	705
1530	S1012	-4116	560
1531	S1013	-4130	705
1532	S1014	-4144	560
1533	S1015	-4158	705
1534	S1016	-4172	560
1535	S1017	-4186	705
1536	S1018	-4200	560

1537	S1019	-4214	705
1538	S1020	-4228	560
1539	S1021	-4242	705
1540	S1022	-4256	560
1541	S1023	-4270	705
1542	S1024	-4284	560
1543	S1025	-4298	705
1544	S1026	-4312	560
1545	S1027	-4326	705
1546	S1028	-4340	560
1547	S1029	-4354	705
1548	S1030	-4368	560
1549	S1031	-4382	705
1550	S1032	-4396	560
1551	S1033	-4410	705
1552	S1034	-4424	560
1553	S1035	-4438	705
1554	S1036	-4452	560
1555	S1037	-4466	705
1556	S1038	-4480	560
1557	S1039	-4494	705
1558	S1040	-4508	560
1559	S1041	-4522	705
1560	S1042	-4536	560
1561	S1043	-4550	705
1562	S1044	-4564	560
1563	S1045	-4578	705
1564	S1046	-4592	560
1565	S1047	-4606	705
1566	S1048	-4620	560
1567	S1049	-4634	705
1568	S1050	-4648	560
1569	S1051	-4662	705
1570	S1052	-4676	560
1571	S1053	-4690	705
1572	S1054	-4704	560
1573	S1055	-4718	705
1574	S1056	-4732	560
1575	S1057	-4746	705
1576	S1058	-4760	560
1577	S1059	-4774	705
1578	S1060	-4788	560
1579	S1061	-4802	705
1580	S1062	-4816	560
1581	S1063	-4830	705
1582	S1064	-4844	560
1583	S1065	-4858	705
1584	S1066	-4872	560
1585	S1067	-4886	705
1586	S1068	-4900	560
1587	S1069	-4914	705
1588	S1070	-4928	560
1589	S1071	-4942	705
1590	S1072	-4956	560
1591	S1073	-4970	705
1592	S1074	-4984	560
1593	S1075	-4998	705

1594	S1076	-5012	560
1595	S1077	-5026	705
1596	S1078	-5040	560
1597	S1079	-5054	705
1598	S1080	-5068	560
1599	S1081	-5082	705
1600	S1082	-5096	560
1601	S1083	-5110	705
1602	S1084	-5124	560
1603	S1085	-5138	705
1604	S1086	-5152	560
1605	S1087	-5166	705
1606	S1088	-5180	560
1607	S1089	-5194	705
1608	S1090	-5208	560
1609	S1091	-5222	705
1610	S1092	-5236	560
1611	S1093	-5250	705
1612	S1094	-5264	560
1613	S1095	-5278	705
1614	S1096	-5292	560
1615	S1097	-5306	705
1616	S1098	-5320	560
1617	S1099	-5334	705
1618	S1100	-5348	560
1619	S1101	-5362	705
1620	S1102	-5376	560
1621	S1103	-5390	705
1622	S1104	-5404	560
1623	S1105	-5418	705
1624	S1106	-5432	560
1625	S1107	-5446	705
1626	S1108	-5460	560
1627	S1109	-5474	705
1628	S1110	-5488	560
1629	S1111	-5502	705
1630	S1112	-5516	560
1631	S1113	-5530	705
1632	S1114	-5544	560
1633	S1115	-5558	705
1634	S1116	-5572	560
1635	S1117	-5586	705
1636	S1118	-5600	560
1637	S1119	-5614	705
1638	S1120	-5628	560
1639	S1121	-5642	705
1640	S1122	-5656	560
1641	S1123	-5670	705
1642	S1124	-5684	560
1643	S1125	-5698	705
1644	S1126	-5712	560
1645	S1127	-5726	705
1646	S1128	-5740	560
1647	S1129	-5754	705
1648	S1130	-5768	560
1649	S1131	-5782	705
1650	S1132	-5796	560

1651	S1133	-5810	705
1652	S1134	-5824	560
1653	S1135	-5838	705
1654	S1136	-5852	560
1655	S1137	-5866	705
1656	S1138	-5880	560
1657	S1139	-5894	705
1658	S1140	-5908	560
1659	S1141	-5922	705
1660	S1142	-5936	560
1661	S1143	-5950	705
1662	S1144	-5964	560
1663	S1145	-5978	705
1664	S1146	-5992	560
1665	S1147	-6006	705
1666	S1148	-6020	560
1667	S1149	-6034	705
1668	S1150	-6048	560
1669	S1151	-6062	705
1670	S1152	-6076	560
1671	S1153	-6090	705
1672	S1154	-6104	560
1673	S1155	-6118	705
1674	S1156	-6132	560
1675	S1157	-6146	705
1676	S1158	-6160	560
1677	S1159	-6174	705
1678	S1160	-6188	560
1679	S1161	-6202	705
1680	S1162	-6216	560
1681	S1163	-6230	705
1682	S1164	-6244	560
1683	S1165	-6258	705
1684	S1166	-6272	560
1685	S1167	-6286	705
1686	S1168	-6300	560
1687	S1169	-6314	705
1688	S1170	-6328	560
1689	S1171	-6342	705
1690	S1172	-6356	560
1691	S1173	-6370	705
1692	S1174	-6384	560
1693	S1175	-6398	705
1694	S1176	-6412	560
1695	S1177	-6426	705
1696	S1178	-6440	560
1697	S1179	-6454	705
1698	S1180	-6468	560
1699	S1181	-6482	705
1700	S1182	-6496	560
1701	S1183	-6510	705
1702	S1184	-6524	560
1703	S1185	-6538	705
1704	S1186	-6552	560
1705	S1187	-6566	705
1706	S1188	-6580	560
1707	S1189	-6594	705

1708	S1190	-6608	560
1709	S1191	-6622	705
1710	S1192	-6636	560
1711	S1193	-6650	705
1712	S1194	-6664	560
1713	S1195	-6678	705
1714	S1196	-6692	560
1715	S1197	-6706	705
1716	S1198	-6720	560
1717	S1199	-6734	705
1718	S1200	-6748	560
1719	S1201	-6762	705
1720	S1202	-6776	560
1721	S1203	-6790	705
1722	S1204	-6804	560
1723	S1205	-6818	705
1724	S1206	-6832	560
1725	S1207	-6846	705
1726	S1208	-6860	560
1727	S1209	-6874	705
1728	S1210	-6888	560
1729	S1211	-6902	705
1730	S1212	-6916	560
1731	S1213	-6930	705
1732	S1214	-6944	560
1733	S1215	-6958	705
1734	S1216	-6972	560
1735	S1217	-6986	705
1736	S1218	-7000	560
1737	S1219	-7014	705
1738	S1220	-7028	560
1739	S1221	-7042	705
1740	S1222	-7056	560
1741	S1223	-7070	705
1742	S1224	-7084	560
1743	S1225	-7098	705
1744	S1226	-7112	560
1745	S1227	-7126	705
1746	S1228	-7140	560
1747	S1229	-7154	705
1748	S1230	-7168	560
1749	S1231	-7182	705
1750	S1232	-7196	560
1751	S1233	-7210	705
1752	S1234	-7224	560
1753	S1235	-7238	705
1754	S1236	-7252	560
1755	S1237	-7266	705
1756	S1238	-7280	560
1757	S1239	-7294	705
1758	S1240	-7308	560
1759	S1241	-7322	705
1760	S1242	-7336	560
1761	S1243	-7350	705
1762	S1244	-7364	560
1763	S1245	-7378	705
1764	S1246	-7392	560

1765	S1247	-7406	705
1766	S1248	-7420	560
1767	S1249	-7434	705
1768	S1250	-7448	560
1769	S1251	-7462	705
1770	S1252	-7476	560
1771	S1253	-7490	705
1772	S1254	-7504	560
1773	S1255	-7518	705
1774	S1256	-7532	560
1775	S1257	-7546	705
1776	S1258	-7560	560
1777	S1259	-7574	705
1778	S1260	-7588	560
1779	S1261	-7602	705
1780	S1262	-7616	560
1781	S1263	-7630	705
1782	S1264	-7644	560
1783	S1265	-7658	705
1784	S1266	-7672	560
1785	S1267	-7686	705
1786	S1268	-7700	560
1787	S1269	-7714	705
1788	S1270	-7728	560
1789	S1271	-7742	705
1790	S1272	-7756	560
1791	S1273	-7770	705
1792	S1274	-7784	560
1793	S1275	-7798	705
1794	S1276	-7812	560
1795	S1277	-7826	705
1796	S1278	-7840	560
1797	S1279	-7854	705
1798	S1280	-7868	560
1799	S1281	-7882	705
1800	S1282	-7896	560
1801	S1283	-7910	705
1802	S1284	-7924	560
1803	S1285	-7938	705
1804	S1286	-7952	560
1805	S1287	-7966	705
1806	S1288	-7980	560
1807	S1289	-7994	705
1808	S1290	-8008	560
1809	S1291	-8022	705
1810	S1292	-8036	560
1811	S1293	-8050	705
1812	S1294	-8064	560
1813	S1295	-8078	705
1814	S1296	-8092	560
1815	S1297	-8106	705
1816	S1298	-8120	560
1817	S1299	-8134	705
1818	S1300	-8148	560
1819	S1301	-8162	705
1820	S1302	-8176	560
1821	S1303	-8190	705

1822	S1304	-8204	560
1823	S1305	-8218	705
1824	S1306	-8232	560
1825	S1307	-8246	705
1826	S1308	-8260	560
1827	S1309	-8274	705
1828	S1310	-8288	560
1829	S1311	-8302	705
1830	S1312	-8316	560
1831	S1313	-8330	705
1832	S1314	-8344	560
1833	S1315	-8358	705
1834	S1316	-8372	560
1835	S1317	-8386	705
1836	S1318	-8400	560
1837	S1319	-8414	705
1838	S1320	-8428	560
1839	S1321	-8442	705
1840	S1322	-8456	560
1841	S1323	-8470	705
1842	S1324	-8484	560
1843	S1325	-8498	705
1844	S1326	-8512	560
1845	S1327	-8526	705
1846	S1328	-8540	560
1847	S1329	-8554	705
1848	S1330	-8568	560
1849	S1331	-8582	705
1850	S1332	-8596	560
1851	S1333	-8610	705
1852	S1334	-8624	560
1853	S1335	-8638	705
1854	S1336	-8652	560
1855	S1337	-8666	705
1856	S1338	-8680	560
1857	S1339	-8694	705
1858	S1340	-8708	560
1859	S1341	-8722	705
1860	S1342	-8736	560
1861	S1343	-8750	705
1862	S1344	-8764	560
1863	S1345	-8778	705
1864	S1346	-8792	560
1865	S1347	-8806	705
1866	S1348	-8820	560
1867	S1349	-8834	705
1868	S1350	-8848	560
1869	S1351	-8862	705
1870	S1352	-8876	560
1871	S1353	-8890	705
1872	S1354	-8904	560
1873	S1355	-8918	705
1874	S1356	-8932	560
1875	S1357	-8946	705
1876	S1358	-8960	560
1877	S1359	-8974	705
1878	S1360	-8988	560

1879	S1361	-9002	705
1880	S1362	-9016	560
1881	S1363	-9030	705
1882	S1364	-9044	560
1883	S1365	-9058	705
1884	S1366	-9072	560
1885	S1367	-9086	705
1886	S1368	-9100	560
1887	S1369	-9114	705
1888	S1370	-9128	560
1889	S1371	-9142	705
1890	S1372	-9156	560
1891	S1373	-9170	705
1892	S1374	-9184	560
1893	S1375	-9198	705
1894	S1376	-9212	560
1895	S1377	-9226	705
1896	S1378	-9240	560
1897	S1379	-9254	705
1898	S1380	-9268	560
1899	S1381	-9282	705
1900	S1382	-9296	560
1901	S1383	-9310	705
1902	S1384	-9324	560
1903	S1385	-9338	705
1904	S1386	-9352	560
1905	S1387	-9366	705
1906	S1388	-9380	560
1907	S1389	-9394	705
1908	S1390	-9408	560
1909	S1391	-9422	705
1910	S1392	-9436	560
1911	S1393	-9450	705
1912	S1394	-9464	560
1913	S1395	-9478	705
1914	S1396	-9492	560
1915	S1397	-9506	705
1916	S1398	-9520	560
1917	S1399	-9534	705
1918	S1400	-9548	560
1919	S1401	-9562	705
1920	S1402	-9576	560
1921	S1403	-9590	705
1922	S1404	-9604	560
1923	S1405	-9618	705
1924	S1406	-9632	560
1925	S1407	-9646	705
1926	S1408	-9660	560
1927	S1409	-9674	705
1928	S1410	-9688	560
1929	S1411	-9702	705
1930	S1412	-9716	560
1931	S1413	-9730	705
1932	S1414	-9744	560
1933	S1415	-9758	705
1934	S1416	-9772	560
1935	S1417	-9786	705

1936	S1418	-9800	560
1937	S1419	-9814	705
1938	S1420	-9828	560
1939	S1421	-9842	705
1940	S1422	-9856	560
1941	S1423	-9870	705
1942	S1424	-9884	560
1943	S1425	-9898	705
1944	S1426	-9912	560
1945	S1427	-9926	705
1946	S1428	-9940	560
1947	S1429	-9954	705
1948	S1430	-9968	560
1949	S1431	-9982	705
1950	S1432	-9996	560
1951	S1433	-10010	705
1952	S1434	-10024	560
1953	S1435	-10038	705
1954	S1436	-10052	560
1955	S1437	-10066	705
1956	S1438	-10080	560
1957	S1439	-10094	705
1958	S1440	-10108	560
1959	SDUM2	-10122	705
1960	SDUM3	-10136	560
1961	VSSIDUM58	-10150	705
1962	VSSIDUM59	-10164	560
1963	VGLO	-10178	705
1964	VGLO	-10192	560
1965	VGLO	-10206	705
1966	VGLO	-10220	560
1967	VGLO	-10234	705
1968	VGLO	-10248	560
1969	VGLO	-10262	705
1970	VGLO	-10276	560
1971	VGLO	-10290	705
1972	VGHO	-10304	560
1973	VGHO	-10318	705
1974	VGHO	-10332	560
1975	VGHO	-10346	705
1976	VGHO	-10360	560
1977	VGHO	-10374	705
1978	VGHO	-10388	560
1979	VGHO	-10402	705
1980	VSSIDUM60	-10416	560
1981	VSSIDUM61	-10430	705
1982	VSSIDUM62	-10444	560
1983	VSSIDUM63	-10458	705
1984	VSSIDUM64	-10472	560
1985	VSSIDUM65	-10486	705
1986	VSSIDUM66	-10500	560
1987	VSSIDUM67	-10514	705
1988	VSSIDUM68	-10528	560
1989	VSSIDUM69	-10542	705
1990	VSSIDUM70	-10556	560
1991	VSSIDUM71	-10570	705
1992	VSSIDUM72	-10584	560

1993	VSSIDUM73	-10598	705
1994	VSSIDUM74	-10612	560
1995	VSSIDUM75	-10626	705
1996	VSSIDUM76	-10640	560
1997	VSSIDUM77	-10654	705
1998	VSSIDUM78	-10668	560
1999	VSSIDUM79	-10682	705
2000	VSSIDUM80	-10696	560
2001	VSSIDUM81	-10710	705
2002	VSSIDUM82	-10724	560
2003	VSSIDUM83	-10738	705
2004	VSSIDUM84	-10752	560
2005	VSSIDUM85	-10766	705
2006	VSSIDUM86	-10780	560
2007	VSSIDUM87	-10794	705
2008	VSSIDUM88	-10808	560
2009	VSSIDUM89	-10822	705
2010	VSSIDUM90	-10836	560
2011	VSSIDUM91	-10850	705
2012	VSSIDUM92	-10864	560
2013	VSSIDUM93	-10878	705
2014	VSSIDUM94	-10892	560
2015	VSSIDUM95	-10906	705
2016	VSSIDUM96	-10920	560
2017	VSSIDUM97	-10934	705
2018	VSSIDUM98	-10948	560
2019	VSSIDUM99	-10962	705
2020	VSSIDUM100	-10976	560
2021	VSSIDUM101	-10990	705
2022	VSSIDUM102	-11004	560
2023	VSSIDUM103	-11018	705
2024	GOUT17	-11032	560
2025	GOUT17	-11046	705
2026	GOUT18	-11060	560
2027	GOUT18	-11074	705
2028	GOUT19	-11088	560
2029	GOUT19	-11102	705
2030	GOUT20	-11116	560
2031	GOUT20	-11130	705
2032	GOUT21	-11144	560
2033	GOUT21	-11158	705
2034	GOUT22	-11172	560
2035	GOUT22	-11186	705
2036	GOUT23	-11200	560
2037	GOUT23	-11214	705
2038	GOUT24	-11228	560
2039	GOUT24	-11242	705
2040	GOUT25	-11256	560
2041	GOUT25	-11270	705
2042	GOUT26	-11284	560
2043	GOUT26	-11298	705
2044	GOUT27	-11312	560
2045	GOUT27	-11326	705
2046	GOUT28	-11340	560
2047	GOUT28	-11354	705
2048	GOUT29	-11368	560
2049	GOUT29	-11382	705

2050	GOUT30	-11396	560
2051	GOUT30	-11410	705
2052	VGLO	-11424	560
2053	VGLO	-11438	705
2054	VGLO	-11452	560
2055	VRGH	-11466	705
2056	VRGH	-11480	560
2057	VRGH	-11494	705
2058	LVGL	-11508	560
2059	LVGL	-11522	705
2060	LVGL	-11536	560
2061	GOUT31	-11550	705
2062	GOUT31	-11564	560
2063	GOUT32	-11578	705
2064	GOUT32	-11592	560
2065	VGLO	-11606	705
2066	VGLO	-11620	560
2067	VGLO	-11634	705
2068	VGHO	-11648	560
2069	VGHO	-11662	705
2070	VGHO	-11676	560
2071	PADA4	-11690	705
2072	PADB4	-11704	560
2073	VSSIDUM104	-11718	705
2074	VSSIDUM105	-11732	560
2075	VSSIDUM106	-11760	705

Alignmark LEFT	-11870	687.5
Alignmark RIGHT	11870	687.5

CONFIDENTIAL

6. Block Function Description

Interface

The RM68120 incorporates command method 24-/16-/8-bits bus display command interface. WDR stores data to be written into GRAM or parameters temporarily while RDR stores data read out from GRAM temporarily. When data is written from microcomputer to GRAM, the RM68120 writes firstly to WDR, and then the data is written to GRAM automatically by internal operation. Because read out operation from GRAM is conducted through RDR, first read out data is invalid. Normal data is read out from 2nd read out data.

Address Counter (AC)

Address counter (AC) gives address to GRAM. When command setting address is written to CR, the data is transferred from CR to AC.

When data is written to GRAM, address counter (AC) increments by +1 or -1 automatically. AC after data is read out increments by +1 or -1 likewise. The RM68120 writes data to only rectangular area that was specified by GRAM.

Graphic RAM (GRAM)

The graphic RAM (GRAM) stores 1,244,160 bytes pattern data using 24 bits for one pixel, enabling maximum 480RGB x 864 dot graphic display.

Grayscale Voltage Generating Circuit

Grayscale voltage generating circuit generates an TFT-LCD drive voltage, which corresponds to grayscale level set in the γ correction register. The RM68120 displays 16.7M colors at the maximum.

Power Supply Circuit

The power supply circuit generates supply voltages to TFT-LCD panel, VREG1OUT, VGH, and VGL.

Timing Generating

The timing generator generates timing signals for internal circuits such as the internal GRAM. The timing for display operation such as RAM read operation and the timing for internal operation such as RAM access by MPU is outputted separately so that they do not interfere with each other.

Oscillator

The RM68120 incorporates RC oscillator circuit. The frame frequency is changeable by command settings.

Panel Driver Circuit

The TFT-LCD display driver circuit consists of 1440 source drivers (S1~S1440). Display pattern data is latched when 1440 data is input. This latched data controls source drivers and outputs drive waveform. The shift direction of 1440-dot output from the source driver can be changed by setting commands. The gate signal consists from GOUT1 to GOUT32 and outputs either VGHR or VGLR level.

CONFIDENTIAL

7. Function Description

7.1 Interface Type Selection

The selection of a given interfaces are done by setting IM3, IM2, IM1 and IM0 pins as show below.

IM[3:0]	Display Data	Command
0000	80-series 8-bit MPU I/F, D[7:0]	80-series 8-bit MPU I/F, D[7:0]
0001	80-series 16-bit MPU I/F, D[15:0]	80-series 16-bit MPU I/F, D[15:0]
0010	80-series 24-bit MPU I/F, D[23:0]	80-series 24-bit MPU I/F, D[23:0]
0011	RGB I/F, D[23:0]	16-bit SPI (SCL rising edge trigger), SDI/SDO
0100	RGB I/F, D[23:0]	I2C I/F, I2C_SDA
0101	MIPI DSI,HSSI_D0_P/N, HSSI_D1_P/N	MIPI DSI,HSSI_D0_P/N, HSSI_D1_P/N
1101	MIPI DSI,HSSI_D0_P/N, HSSI_D1_P/N	MIPI DSI,HSSI_D0_P/N,HSSI_D1_P/N (Video Mode)
0110	MDDI,HSSI_D0_P/N, HSSI_D1_P/N	MDDI, HSSI_D0_P/N, HSSI_D1_P/N 16-bit SPI (SCL rising edge trigger), SDI/SDO
1110	MDDI,HSSI_D0_P/N, HSSI_D1_P/N	MDDI, HSSI_D0_P/N, HSSI_D1_P/N 16-bit SPI (SCL falling edge trigger), SDI/SDO
0111	MDDI,HSSI_D0_P/N, HSSI_D1_P/N	MDDI, HSSI_D0_P/N, HSSI_D1_P/N I2C I/F, I2C_SDA serial data
1011	RGB I/F, D[23:0]	16-bit SPI (SCL falling edge trigger), SDI/SDO

7.2 Display Bus Interface (DBI)

The RM68120 uses a 28-wires 24-bit parallel interface. The chip-select CSX (active low) enables and disables the DBI interface. RESX (active low) is an external reset signal. WRX is the data write, RDX is the data read and DB[23:0] is parallel DBI data. There are three 24/16/8-bit types interface supported for the display data transfer. The graphics controller chip reads the data at the rising edge of RDX signal. The DCX is data/command flag. When DCX = "1", D23 to D0 bits are display RAM data or command parameters. When DCX = "0", D7 to D0 bits are commands.

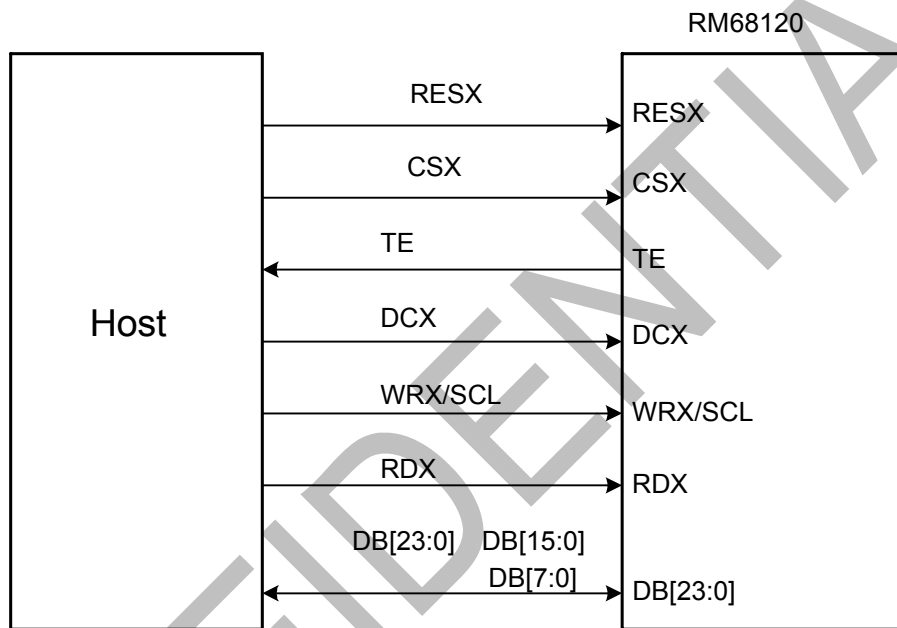

7.2.1 Write Cycle

During a write cycle the host processor sends data to the display module via the interface. The Type B interface utilizes DCX, RDX and WRX signals as well as all information signals (DB[23:0]). WRX is driven from high to low then pulled back to high during the write cycle. The host processor provides information during the write cycle while the display module reads the host processor information on the rising edge of WRX. DCX is driven low while command information is on the interface and is pulled high when data is present.

The following figure shows a write cycle for the type B interface.

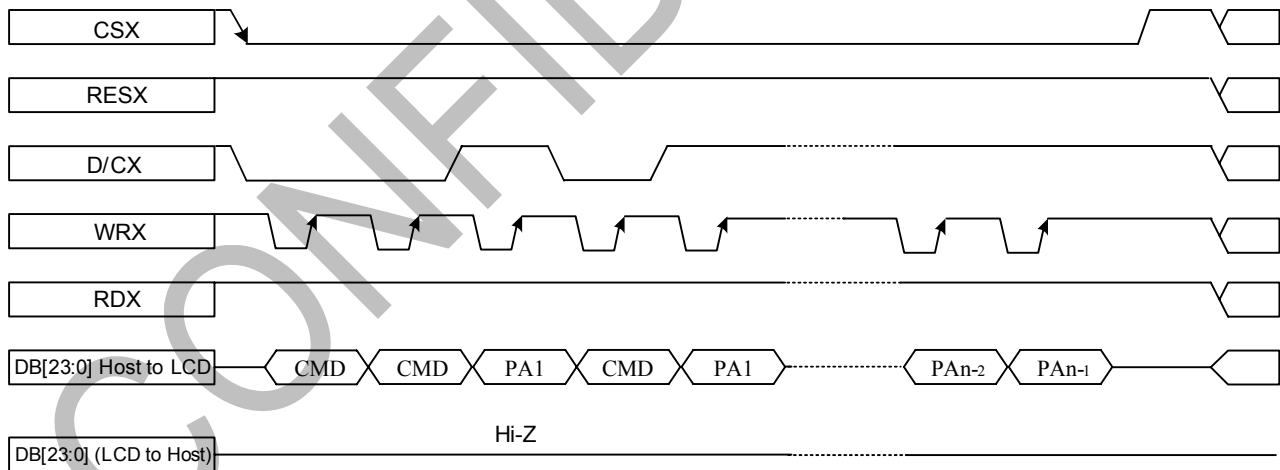
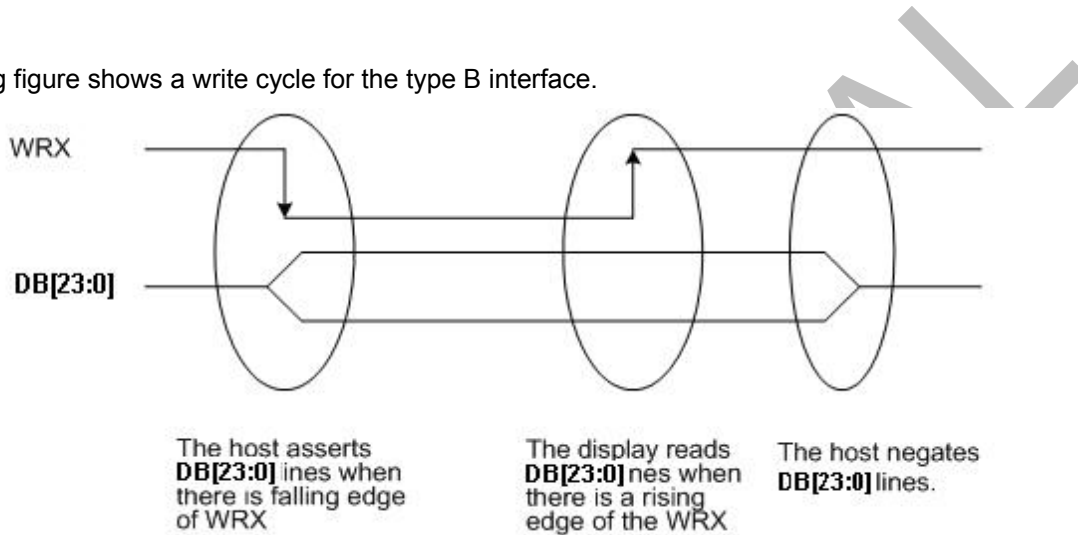

7.2.2 Read Cycle

During a read cycle the host processor reads data from the display module via the interface. The Type B interface utilizes DCX, RDX and WRX signals as well as all information signals (D[23:0]). RDX is driven from high to low then allowed to be pulled back to high during the read cycle. The display module provides information to the host processor during the read cycle while the host processor reads the display module information on the rising edge of RDX. DCX is driven high during the read cycle.

The following figure shows the read cycle for the type B interface.

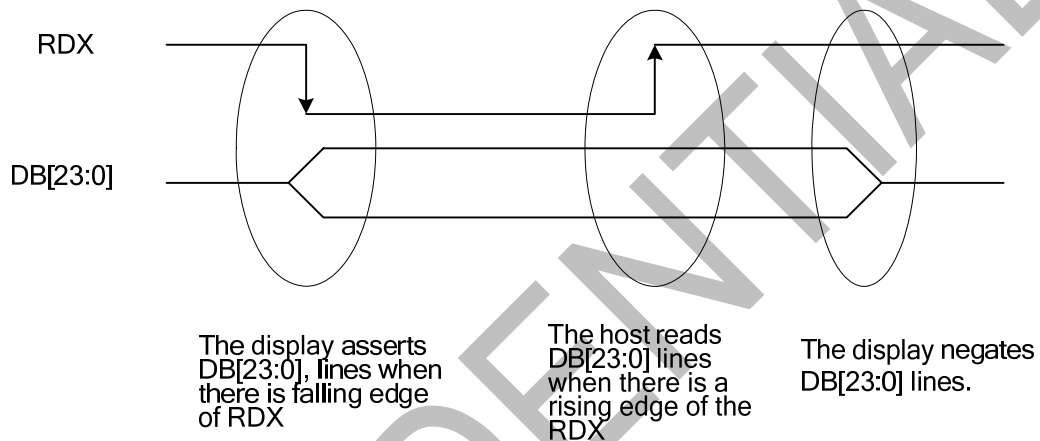

Note: RDX is an unsynchronized signal (It can be stopped).

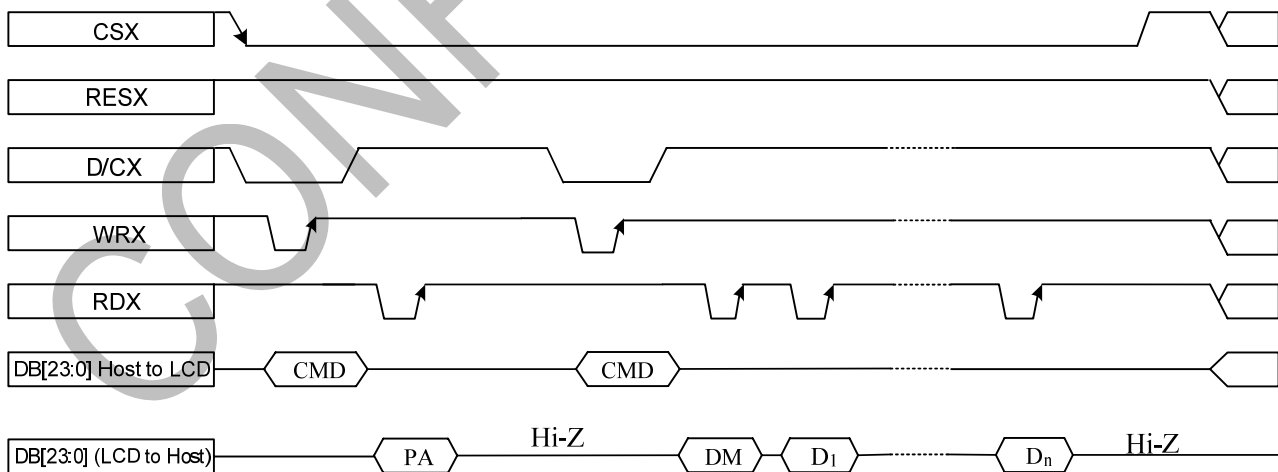

Note: Read Data is only valid when the DCX input is pulled high. If DCX is driven low during read then the display information outputs will be High-Z.

DBI Type B Interface

24-bit data bus DB[23:0] interface, IM[3:0] = 0010

IFPF[3:0]: command_3A[3:0]

	IFPF	DB 23	DB 22	DB 21	DB 20	DB 19	DB 18	DB 17	DB 16	DB 15	DB 14	DB 13	DB 12	DB 11	DB 10	DB 9	DB 8	DB 7	DB 6	DB 5	DB 4	DB 3	DB 2	DB 1	DB 0
Command Write	*																	D[7]	D[6]	D[5]	D[4]	D[3]	D[2]	D[1]	D[0]
Command Read	*																	D[7]	D[6]	D[5]	D[4]	D[3]	D[2]	D[1]	D[0]

	IFPF	DB 23	DB 22	DB 21	DB 20	DB 19	DB 18	DB 17	DB 16	DB 15	DB 14	DB 13	DB 12	DB 11	DB 10	DB 9	DB 8	DB 7	DB 6	DB 5	DB 4	DB 3	DB 2	DB 1	DB 0	color
Memory Write	5									R[4]	R[3]	R[2]	R[1]	R[0]	G[5]	G[4]	G[3]	G[2]	G[1]	G[0]	B[4]	B[3]	B[2]	B[1]	B[0]	65K
	6							R[5]	R[4]	R[3]	R[2]	R[1]	R[0]	G[5]	G[4]	G[3]	G[2]	G[1]	G[0]	B[5]	B[4]	B[3]	B[2]	B[1]	B[0]	262K
	7	R[7]	R[6]	R[5]	R[4]	R[3]	R[2]	R[1]	R[0]	G[7]	G[6]	G[5]	G[4]	G[3]	G[2]	G[1]	G[0]	B[7]	B[6]	B[5]	B[4]	B[3]	B[2]	B[1]	B[0]	16.7M

The read data for RGB is 24 bit output as below.

	DB 23	DB 22	DB 21	DB 20	DB 19	DB 18	DB 17	DB 16	DB 15	DB 14	DB 13	DB 12	DB 11	DB 10	DB 9	DB 8	DB 7	DB 6	DB 5	DB 4	DB 3	DB 2	DB 1	DB 0	color
Memory Read	R[7]	R[6]	R[5]	R[4]	R[3]	R[2]	R[1]	R[0]	G[7]	G[6]	G[5]	G[4]	G[3]	G[2]	G[1]	G[0]	B[7]	B[6]	B[5]	B[4]	B[3]	B[2]	B[1]	B[0]	16.7M

16-bit data bus DB[15:0] interface, IM[3:0] = 0001

	IFPF	DB 15	DB 14	DB 13	DB 12	DB 11	DB 10	DB 9	DB 8	DB 7	DB 6	DB 5	DB 4	DB 3	DB 2	DB 1	DB 0
Command Write	*	/	/	/	/	/	/	/	/	D[7]	D[6]	D[5]	D[4]	D[3]	D[2]	D[1]	D[0]
Command Read	*	/	/	/	/	/	/	/	/	D[7]	D[6]	D[5]	D[4]	D[3]	D[2]	D[1]	D[0]

	IFPF	DB 15	DB 14	DB 13	DB 12	DB 11	DB 10	DB 9	DB 8	DB 7	DB 6	DB 5	DB 4	DB 3	DB 2	DB 1	DB 0	color
Memory Write	5	R[4]	R[3]	R[2]	R[1]	R[0]	G[5]	G[4]	G[3]	G[2]	G[1]	G[0]	B[4]	B[3]	B[2]	B[1]	B[0]	65K
	6	R[5]	R[4]	R[3]	R[2]	R[1]	R[0]	X	X	G[5]	G[4]	G[3]	G[2]	G[1]	G[0]	X	X	262K
		B[5]	B[4]	B[3]	B[2]	B[1]	B[0]	X	X	R[5]	R[4]	R[3]	R[2]	R[1]	R[0]	X	X	
		G[5]	G[4]	G[3]	G[2]	G[1]	G[0]	X	X	B[5]	B[4]	B[3]	B[2]	B[1]	B[0]	X	X	
	7	R[7]	R[6]	R[5]	R[4]	R[3]	R[2]	R[1]	R[0]	G[7]	G[6]	G[5]	G[4]	G[3]	G[2]	G[1]	G[0]	16.7M
		B[7]	B[6]	B[5]	B[4]	B[3]	B[2]	B[1]	B[0]	R[7]	R[6]	R[5]	R[4]	R[3]	R[2]	R[1]	R[0]	
		G[7]	G[6]	G[5]	G[4]	G[3]	G[2]	G[1]	G[0]	B[7]	B[6]	B[5]	B[4]	B[3]	B[2]	B[1]	B[0]	

The read data for RGB is 16 bit output as below.

	DB 15	DB 14	DB 13	DB 12	DB 11	DB 10	DB 9	DB 8	DB 7	DB 6	DB 5	DB 4	DB 3	DB 2	DB 1	DB 0	color
Memory Read	R[7]	R[6]	R[5]	R[4]	R[3]	R[2]	R[1]	R[0]	G[7]	G[6]	G[5]	G[4]	G[3]	G[2]	G[1]	G[0]	16.7M
	B[7]	B[6]	B[5]	B[4]	B[3]	B[2]	B[1]	B[0]	/	/	/	/	/	/	/	/	

8-bit data bus DB[7:0] interface, IM[3:0] = 0000

	IFPF	DB 7	DB 6	DB 5	DB 4	DB 3	DB 2	DB 1	DB 0
Command Write	*	D[7]	D[6]	D[5]	D[4]	D[3]	D[2]	D[1]	D[0]
Command Read	*	D[7]	D[6]	D[5]	D[4]	D[3]	D[2]	D[1]	D[0]

	IFPF	DB 7	DB 6	DB 5	DB 4	DB 3	DB 2	DB 1	DB 0	color
Memory Write	5	R[4]	R[3]	R[2]	R[1]	R[0]	G[5]	G[4]	G[3]	65K
		G[2]	G[1]	G[0]	B[4]	B[3]	B[2]	B[1]	B[0]	
	6	R[5]	R[4]	R[3]	R[2]	R[1]	R[0]	X	X	262K
		G[5]	G[4]	G[3]	G[2]	G[1]	G[0]	X	X	
		B[5]	B[4]	B[3]	B[2]	B[1]	B[0]	X	X	
	7	R[7]	R[6]	R[5]	R[4]	R[3]	R[2]	R[1]	R[0]	16.7M
		G[7]	G[6]	G[5]	G[4]	G[3]	G[2]	G[1]	G[0]	
		B[7]	B[6]	B[5]	B[4]	B[3]	B[2]	B[1]	B[0]	

The read data for RGB is 8 bit output as below.

	DB 7	DB 6	DB 5	DB 4	DB 3	DB 2	DB 1	DB 0	color
Memory Read	R[7]	R[6]	R[5]	R[4]	R[3]	R[2]	R[1]	R[0]	16.7M
	G[7]	G[6]	G[5]	G[4]	G[3]	G[2]	G[1]	G[0]	
	B[7]	B[6]	B[5]	B[4]	B[3]	B[2]	B[1]	B[0]	

7.3 Serial Interface

7.3.1 Write Cycle and Sequence

During a write cycle the host processor sends a single bit of data to the display module via the interface. The SPI interface utilizes CSX, SCL and SDI and SDO signals. SCL is driven from high to low then pulled back to high during the write cycle. The host processor provides information during the write cycle while the display module reads the host processor information on the rising edge of SCL.

During the write sequence the host processor writes one or more bytes of information to the display module via the interface. The write sequence is initiated when CSX is driven from high to low and ends when CSX is pulled high. Each byte is either nine or sixteen write cycles in length. If the optional DCX signal is used a byte is eight write cycles long. DCX is driven low while command information is on the interface and is pulled high when data is present.

The SPI interface write command sequences are described in the following figure.

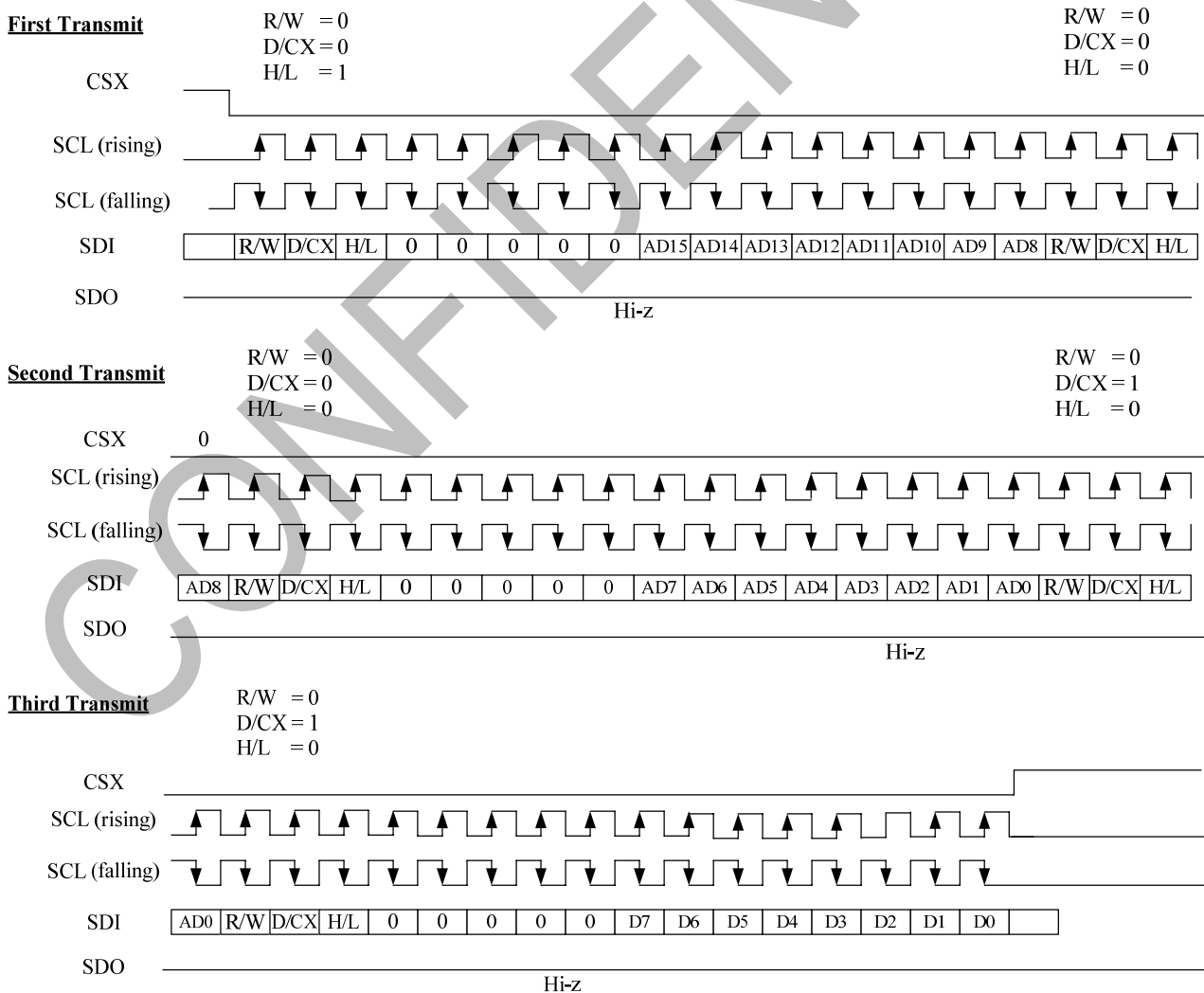

The SPI interface write data sequences are described in the following figure.

SRAM write: 65K colors, RGB 5-6-5 pixel data input (parameter of command 3A00h is 0x0005)

First Transmit

R/W = 0
D/CX = 0
H/L = 1

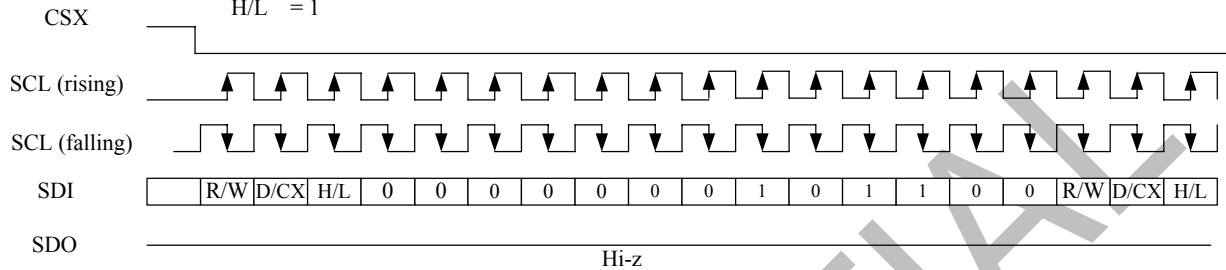

Second Transmit

R/W = 0
D/CX = 0
H/L = 0

R/W = 0
D/CX = 1
H/L = 0

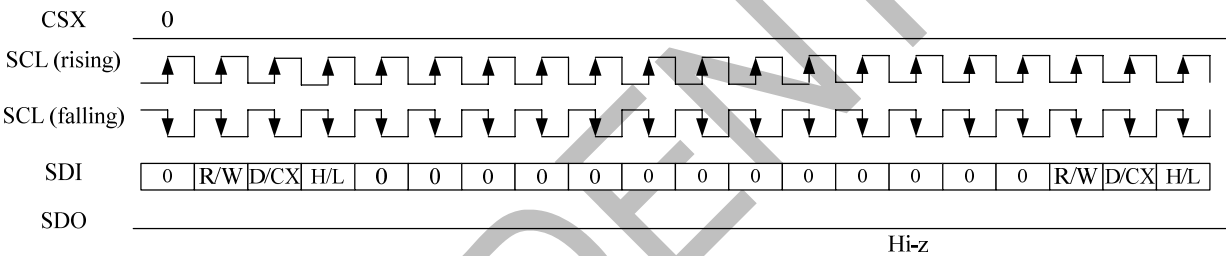

Third Transmit (RED)

R/W = 0
D/CX = 1
H/L = 0

R/W = 0
D/CX = 1
H/L = 0

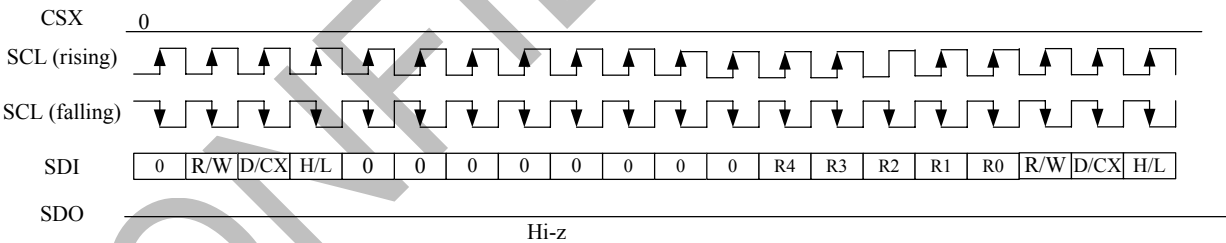

Forth Transmit (GREEN)

R/W = 0
D/CX = 1
H/L = 0

R/W = 0
D/CX = 1
H/L = 0

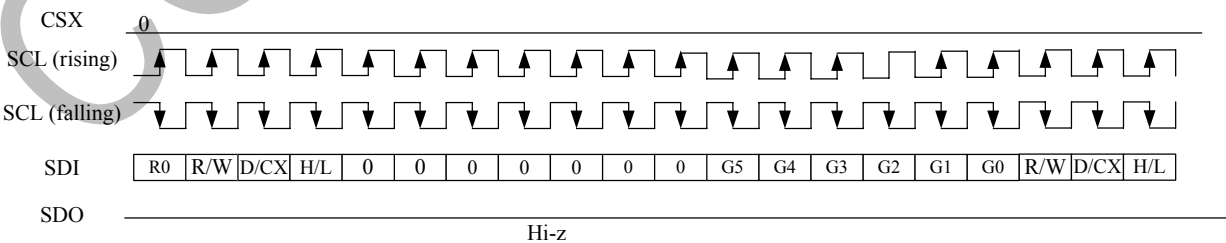

**Fifth Transmit
(BLUE)**

R/W = 0
D/CX = 1
H/L = 0

R/W = 0
D/CX = 1
H/L = 0

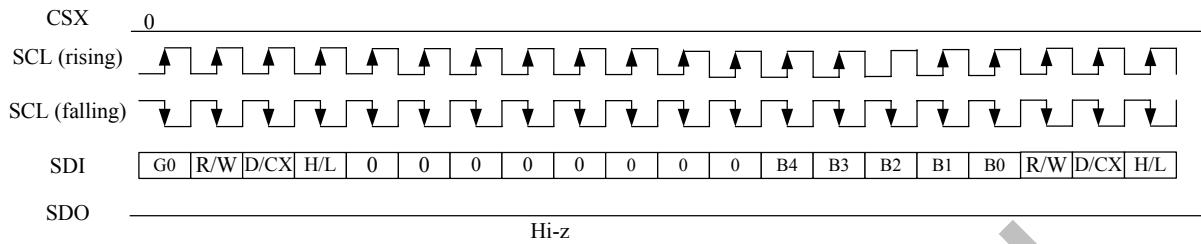

**Sixth Transmit
(RED)**

R/W = 0
D/CX = 1
H/L = 0

R/W = 0
D/CX = 1
H/L = 0

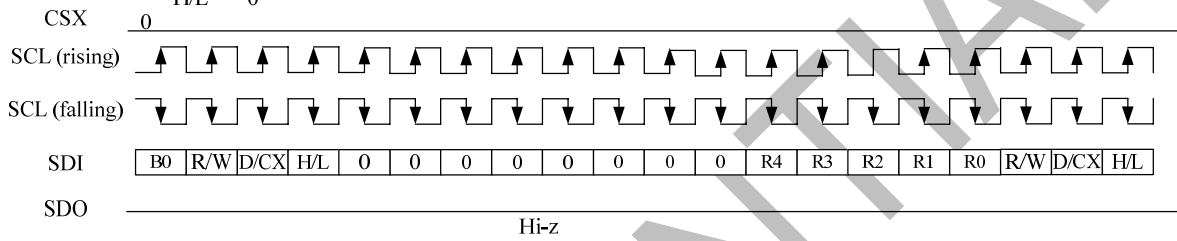

CONFIDENTIAL

SRAM write: 262K colors, RGB 6-6-6 pixel data input (parameter of command 3A00h is 0x0006)

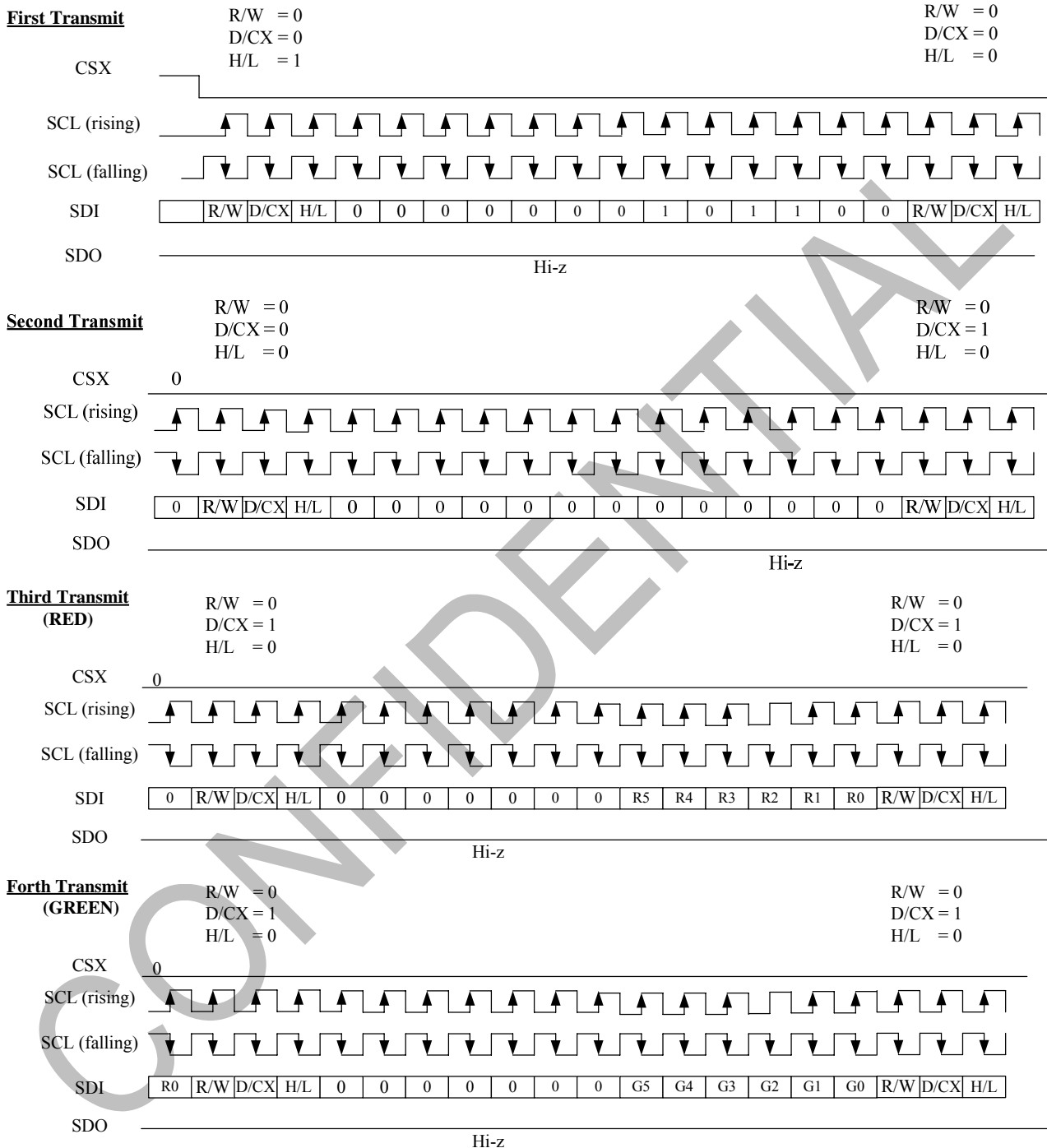

**Fifth Transmit
(BLUE)**

R/W = 0
D/CX = 1
H/L = 0

R/W = 0
D/CX = 1
H/L = 0

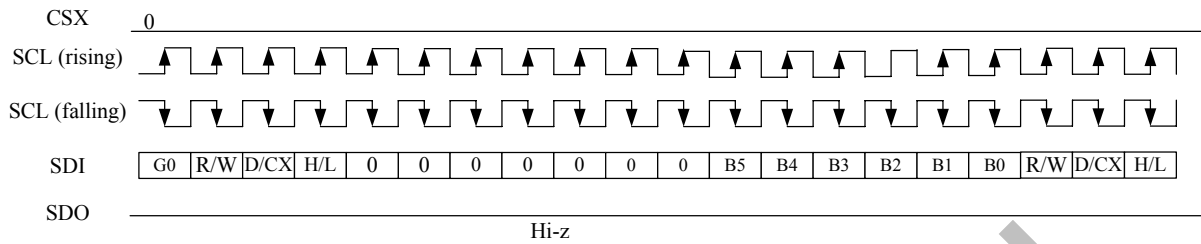

**Sixth Transmit
(RED)**

R/W = 0
D/CX = 1
H/L = 0

R/W = 0
D/CX = 1
H/L = 0

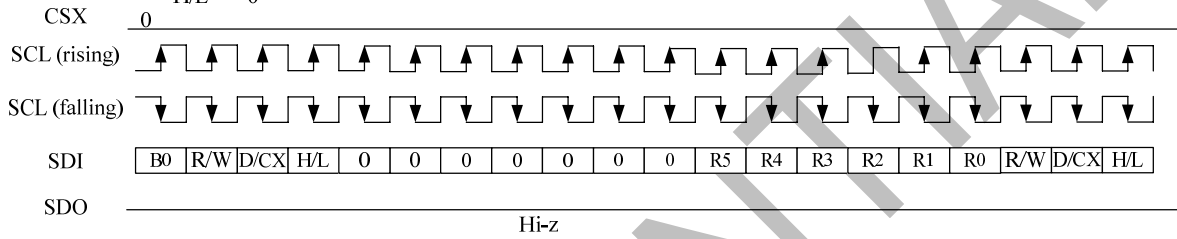

CONFIDENTIAL

SRAM write: 16.7K colors, RGB 8-8-8 pixel data input (parameter of command 3A00h is 0x0007)

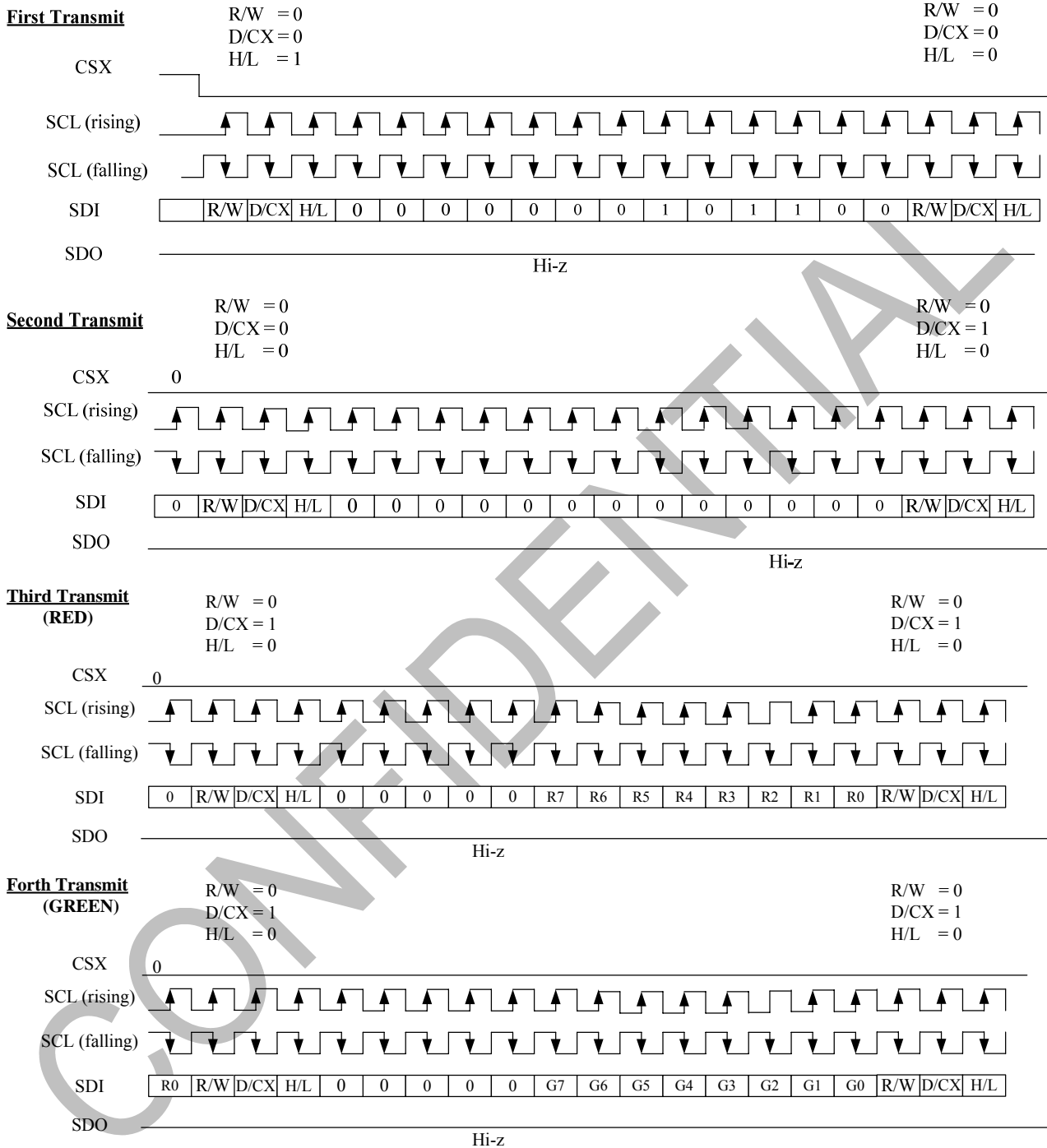

**Fifth Transmit
(BLUE)**

R/W = 0
D/CX = 1
H/L = 0

R/W = 0
D/CX = 1
H/L = 0

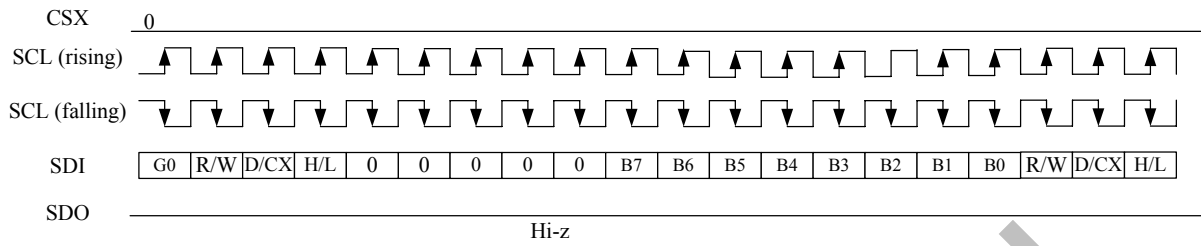

**Sixth Transmit
(RED)**

R/W = 0
D/CX = 1
H/L = 0

R/W = 0
D/CX = 1
H/L = 0

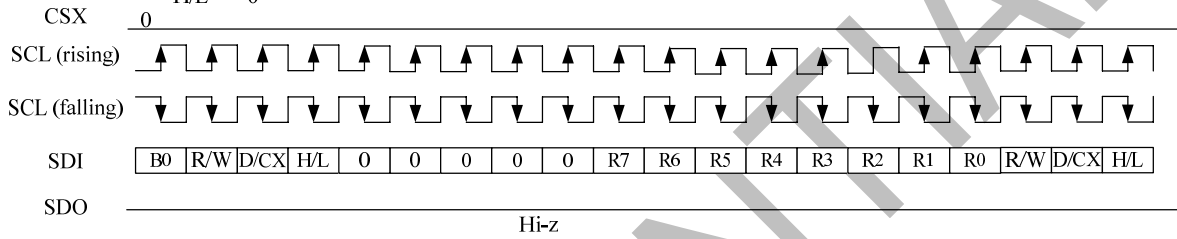

CONFIDENTIAL

7.3.2 Read Cycle and Sequence

During a read cycle the host processor reads a single bit of data from the display module via the interface. The SPI interface utilizes CSX, SCL and DIN signals. SCL is driven from high to low then pulled back to high during the read cycle. The display module provides information during the read cycle while the host processor reads the display module information on the rising edge of SCL.

During the read sequence the host processor reads one or more bytes of information from the display module via the interface. The read sequence is initiated when CSX is driven from high to low and ends when CSX is pulled high. Each byte is either nine or sixteen write cycles in length. If the optional DCX signal is used a byte is eight read cycles long. DCX is driven low while command information is on the interface and is pulled high when data is present.

The SPI interface read command sequences are described in the following figure.

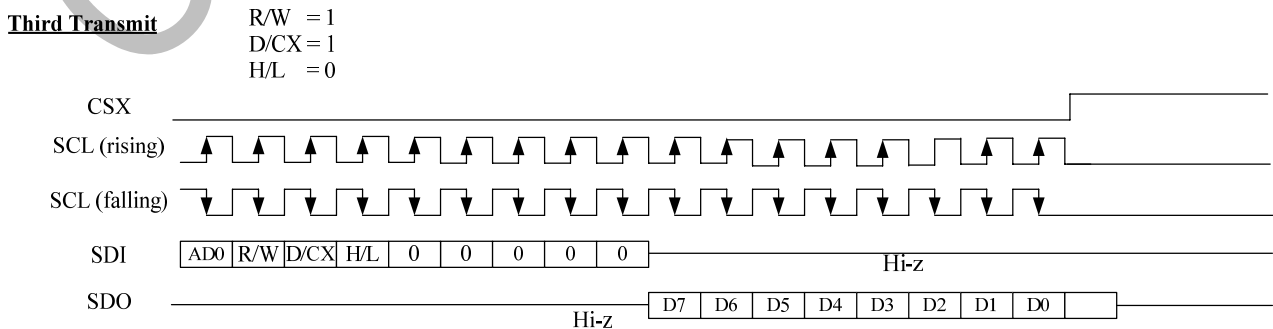
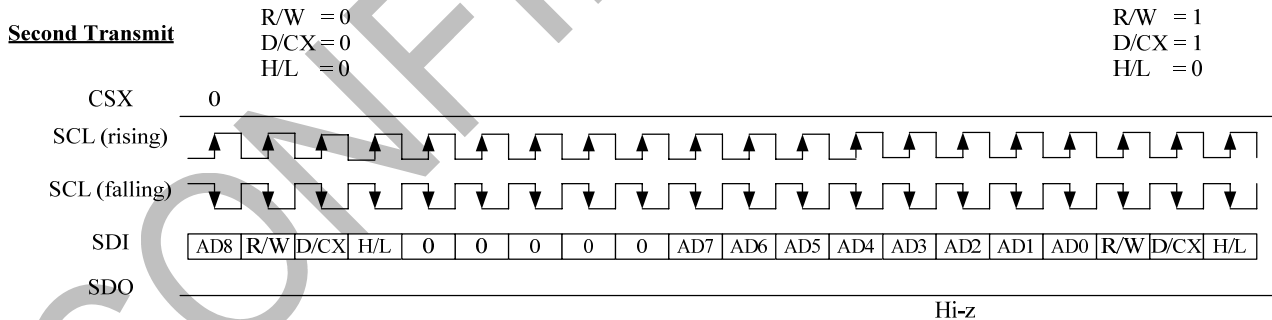
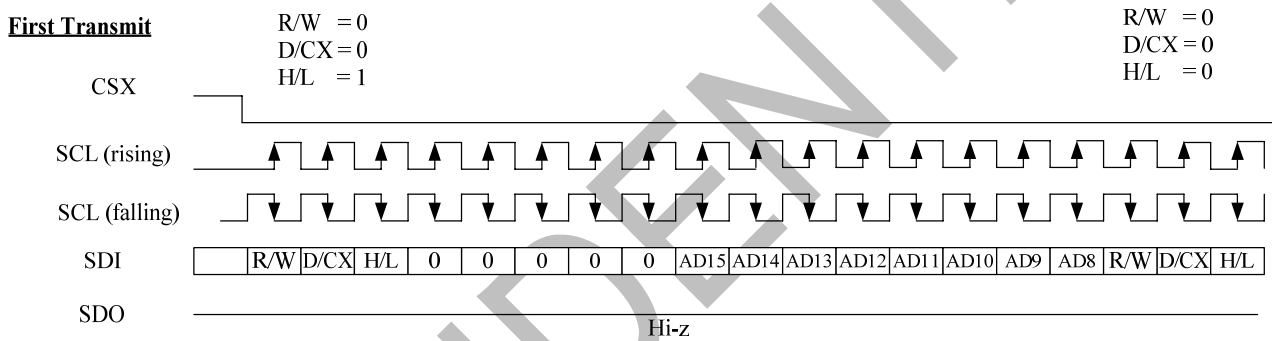

The SPI interface read data sequences are described in the following figure.

SRAM read: 65K colors, RGB 5-6-5 pixel data input (parameter of command 3A00h is 0x0005)

First Transmit

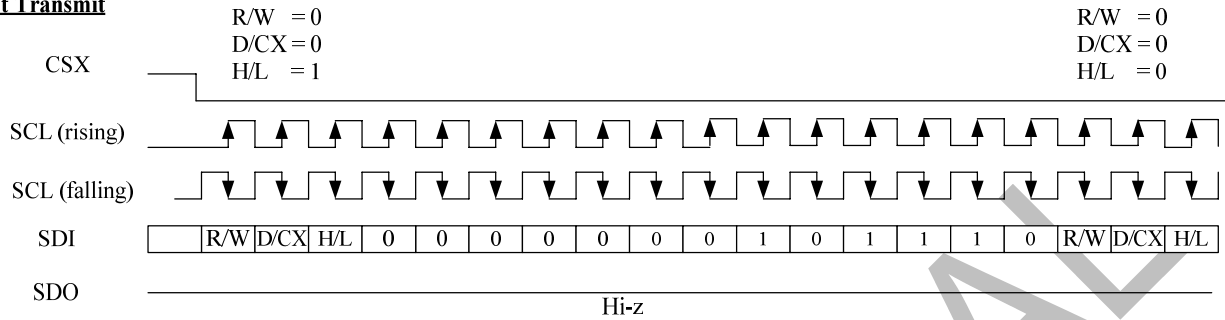

Second Transmit

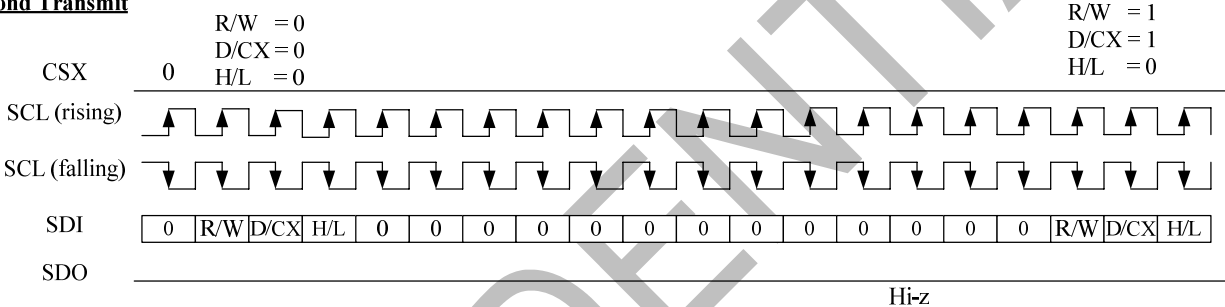

Third Transmit (Dummy)

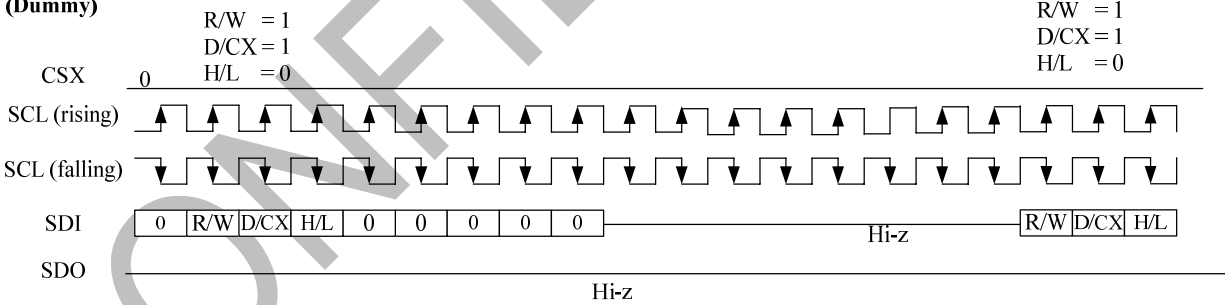

Forth Transmit (RED)

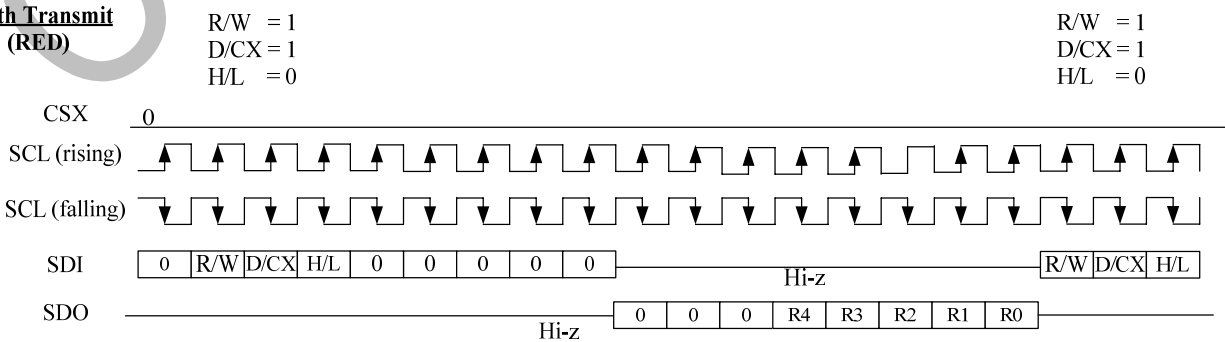

**Fifth Transmit
(GREEN)**

R/W = 1
D/CX = 1
H/L = 0

R/W = 1
D/CX = 1
H/L = 0

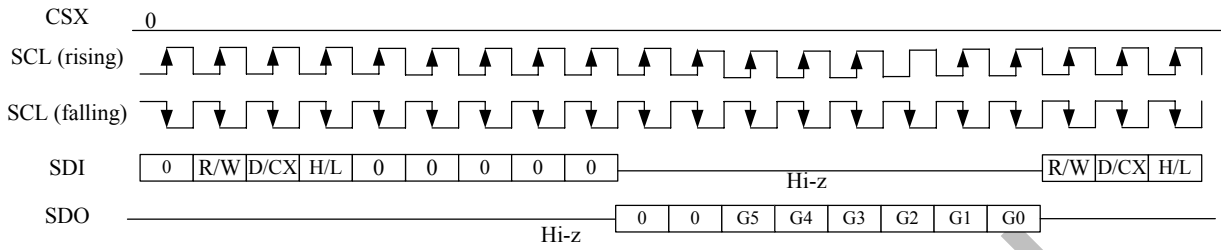

**Sixth Transmit
(BLUE)**

R/W = 1
D/CX = 1
H/L = 0

R/W = 1
D/CX = 1
H/L = 0

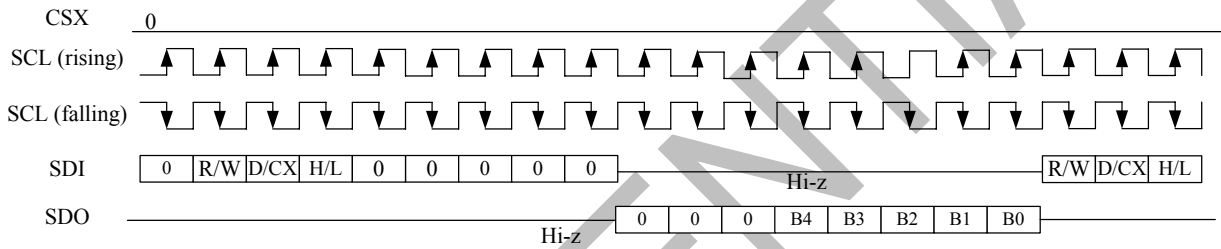

**Seventh Transmit
(RED)**

R/W = 1
D/CX = 1
H/L = 0

R/W = 1
D/CX = 1
H/L = 0

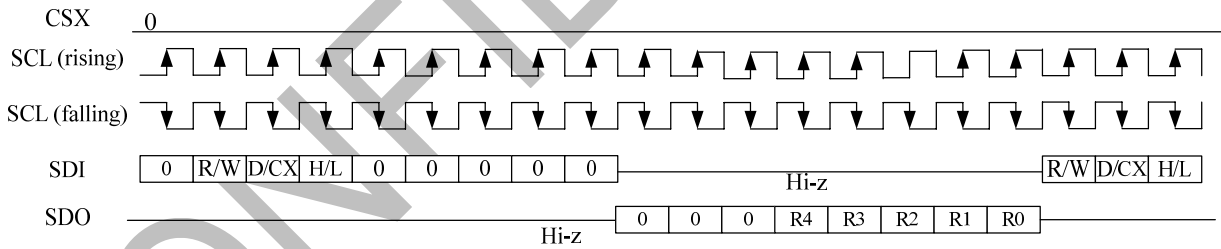

SRAM read: 262K colors, RGB 6-6-6 pixel data input (parameter of command 3A00h is 0x0006)

First Transmit

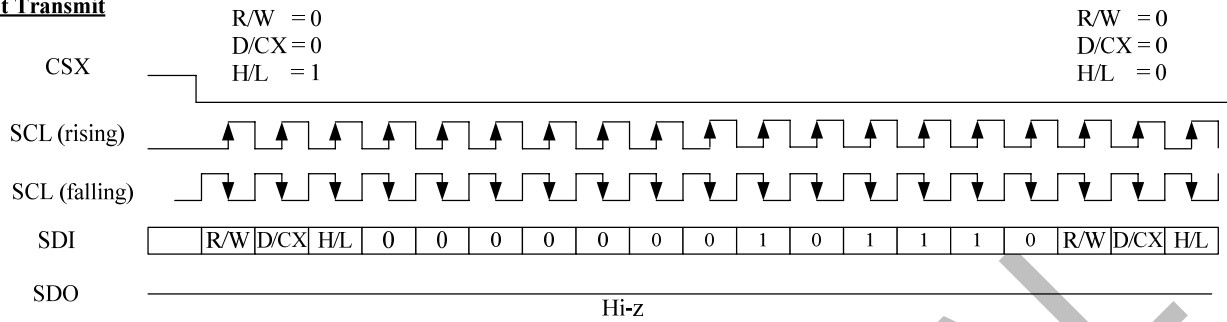

Second Transmit

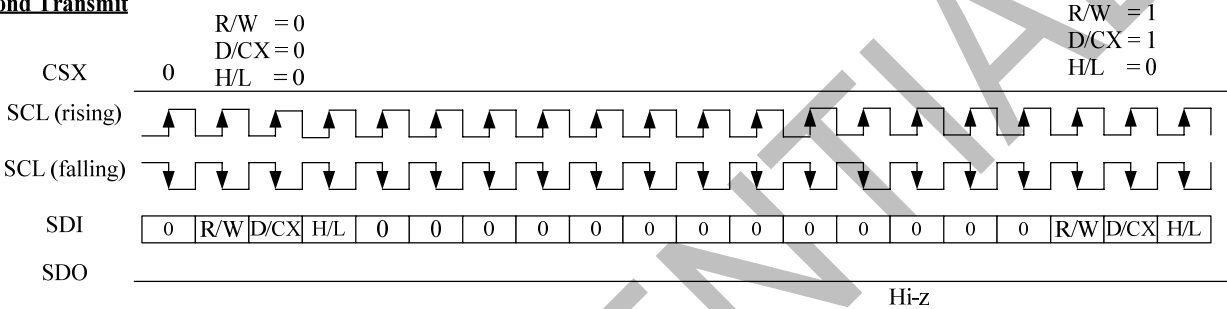

Third Transmit (Dummy)

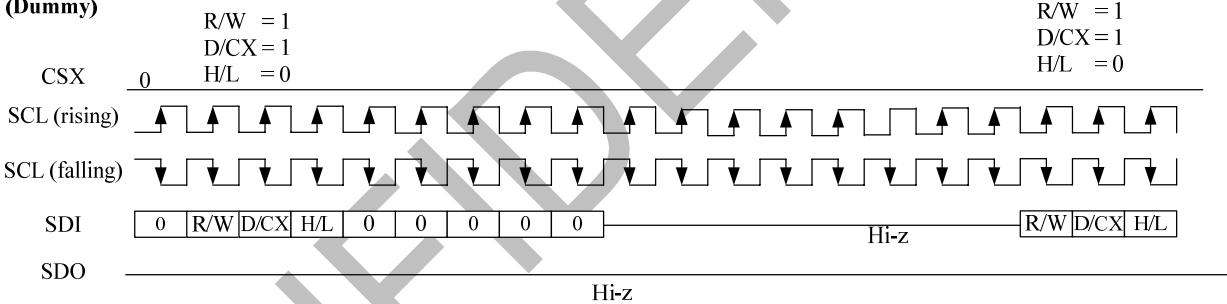

Forth Transmit (RED)

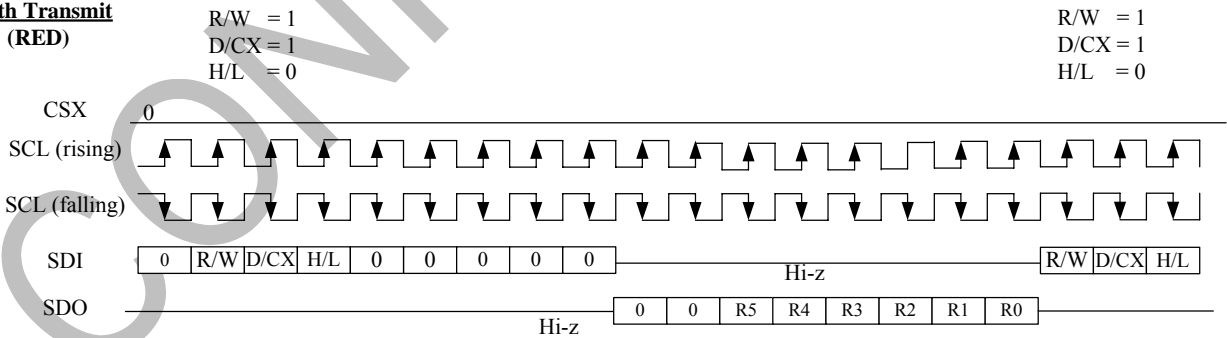

**Fifth Transmit
(GREEN)**

R/W = 1
D/CX = 1
H/L = 0

R/W = 1
D/CX = 1
H/L = 0

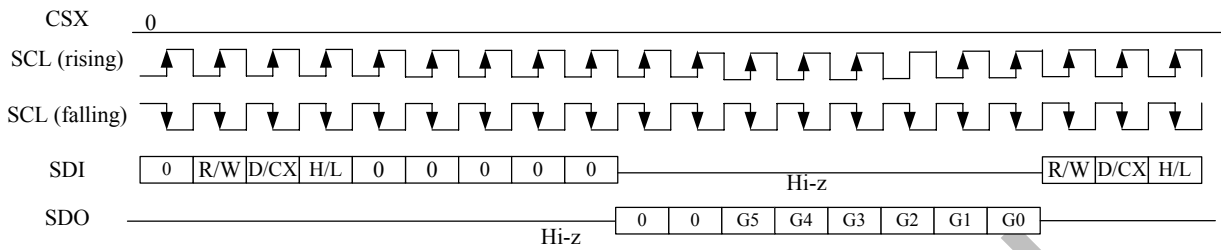

**Sixth Transmit
(BLUE)**

R/W = 1
D/CX = 1
H/L = 0

R/W = 1
D/CX = 1
H/L = 0

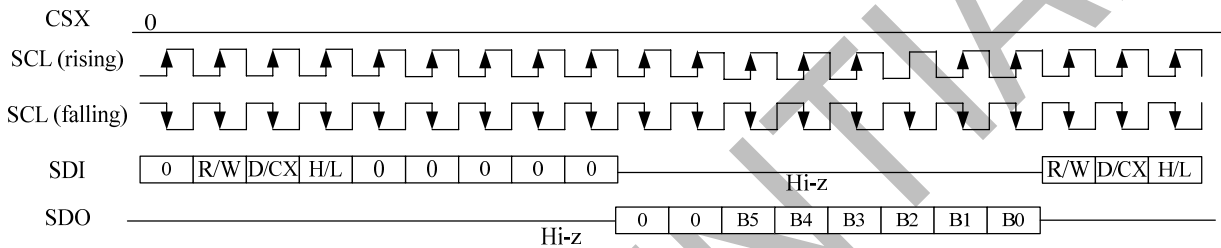

**Seventh Transmit
(RED)**

R/W = 1
D/CX = 1
H/L = 0

R/W = 1
D/CX = 1
H/L = 0

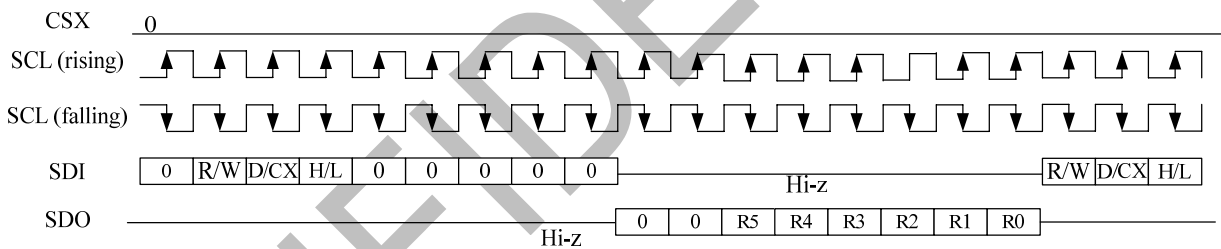

SRAM read: 16.7M colors, RGB 8-8-8 pixel data input (parameter of command 3A00h is 0x0007)

First Transmit

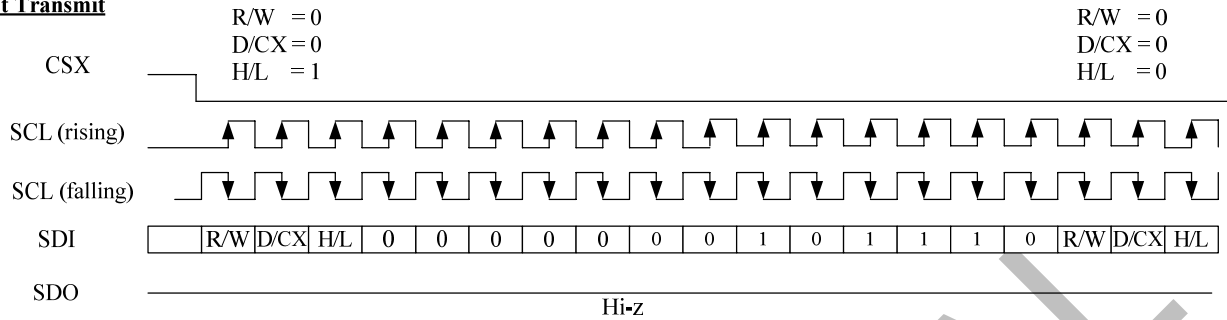

Second Transmit

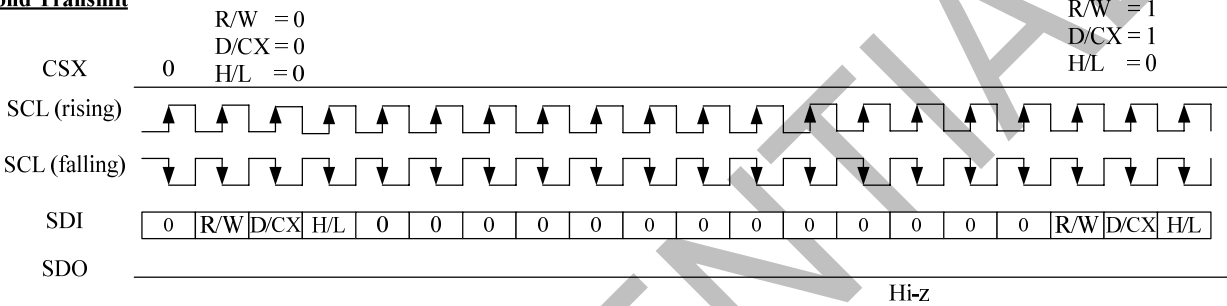

Third Transmit (Dummy)

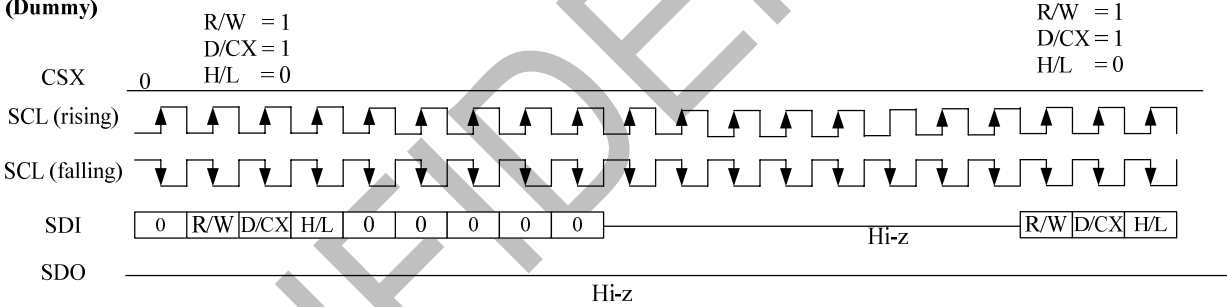

Forth Transmit (RED)

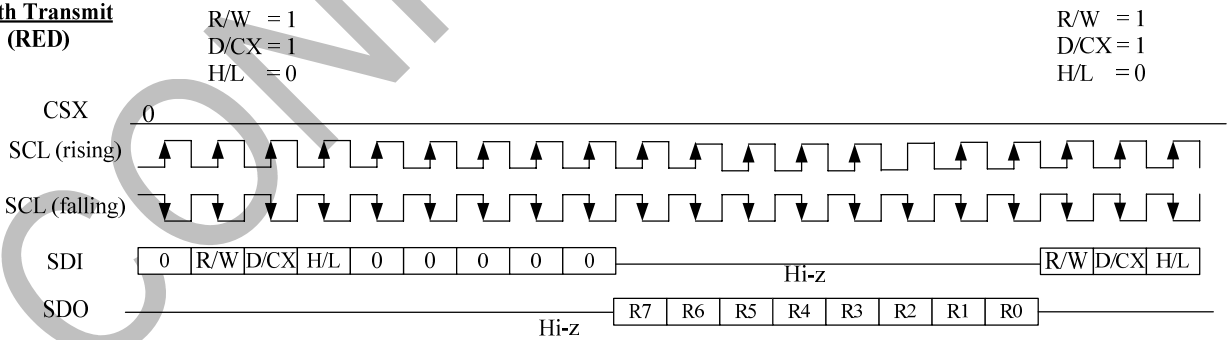

**Fifth Transmit
(GREEN)**

R/W = 1
D/CX = 1
H/L = 0

R/W = 1
D/CX = 1
H/L = 0

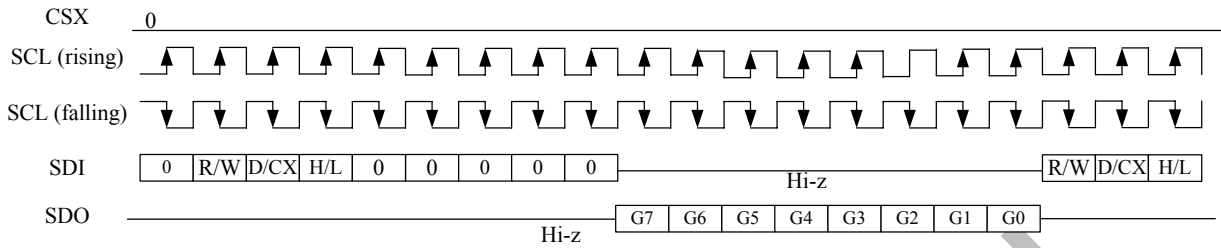

**Sixth Transmit
(BLUE)**

R/W = 1
D/CX = 1
H/L = 0

R/W = 1
D/CX = 1
H/L = 0

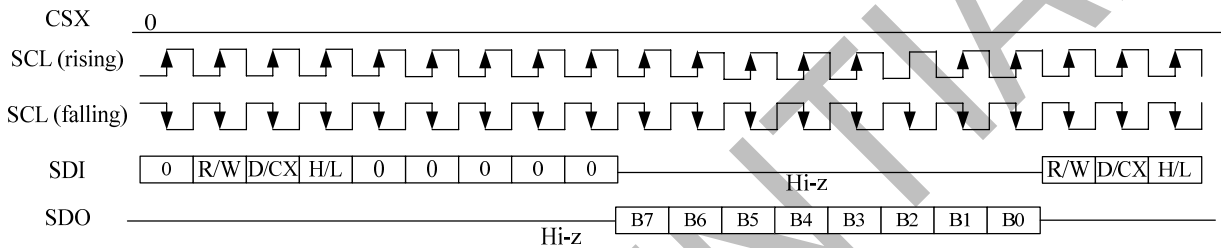

**Seventh Transmit
(RED)**

R/W = 1
D/CX = 1
H/L = 0

R/W = 1
D/CX = 1
H/L = 0

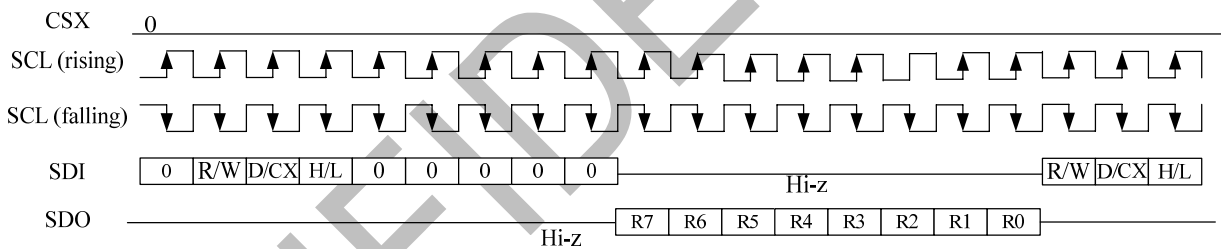

7.3.3 Break and Pause Sequences

The host processor can break a read or write sequence by pulling the CSX signal high during a command or data byte. The display module shall reset its interface so it will be ready to receive the same byte when CSX is again driven low.

The host processor can pause a read or write sequence by pulling the CSX signal high between command or data bytes. The display module shall wait for the host processor to drive CSX low before continuing the read or write sequence at the point where the sequence was paused.

1. Middle of frame

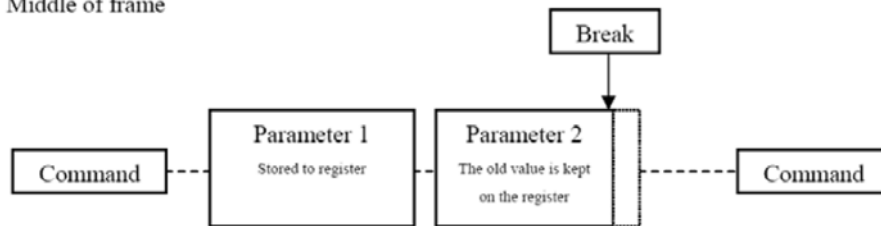

2. Between frames

Without break



With break

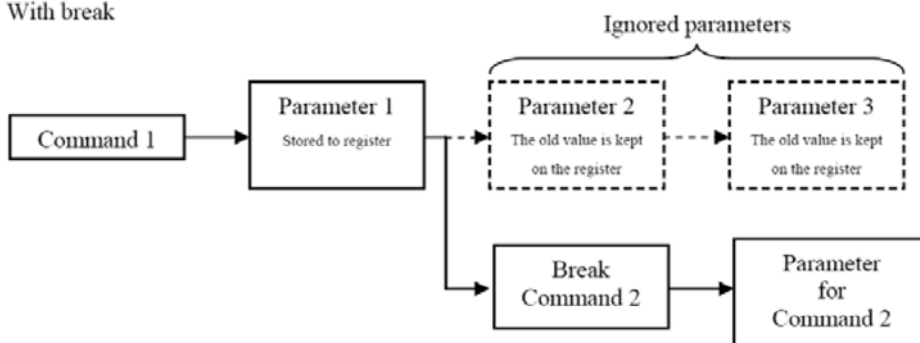

Break can be e.g. another command or noise pulse.

7.4 I2C Interface

The I2C-bus is for bi-directional, two-line communication between different ICs or modules. The two lines are the Serial Data line (I2C_SDA) and the Serial Clock Line (I2C_SCL). Both lines must be connected to a positive supply via pull-up resistors. Data transfer can be initiated only when the bus is not busy. Each byte of eight bits is followed by an acknowledge bit. The acknowledge bit is a HIGH level signal put on the bus by the transmitter during which time the master generates an extra acknowledgement related clock pulse. A slave receiver which is addressed must generate an acknowledgement after the reception of each byte. Also a master receiver must generate an acknowledgement after the reception of each byte that has been clocked out of the slave transmitter.

The I2C interface write command sequences are described in the following figure.

Write Cmd:

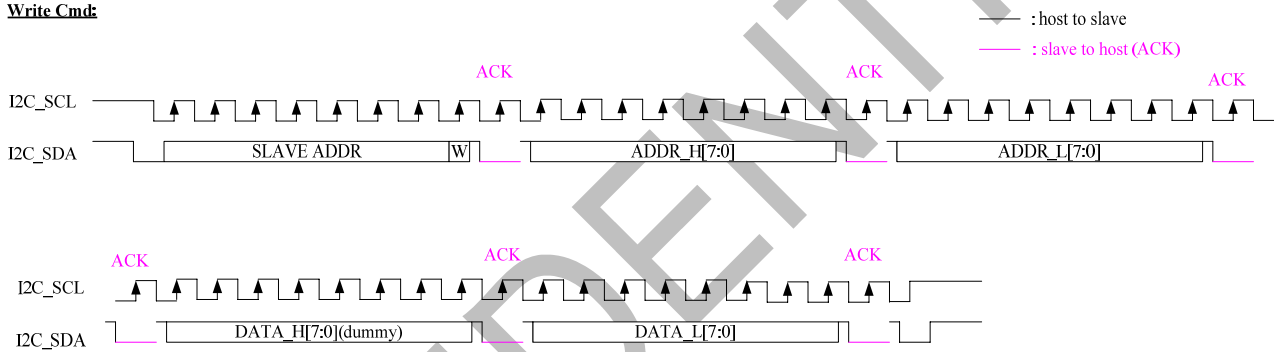

The I2C interface read command sequences are described in the following figure.

Read Cmd:

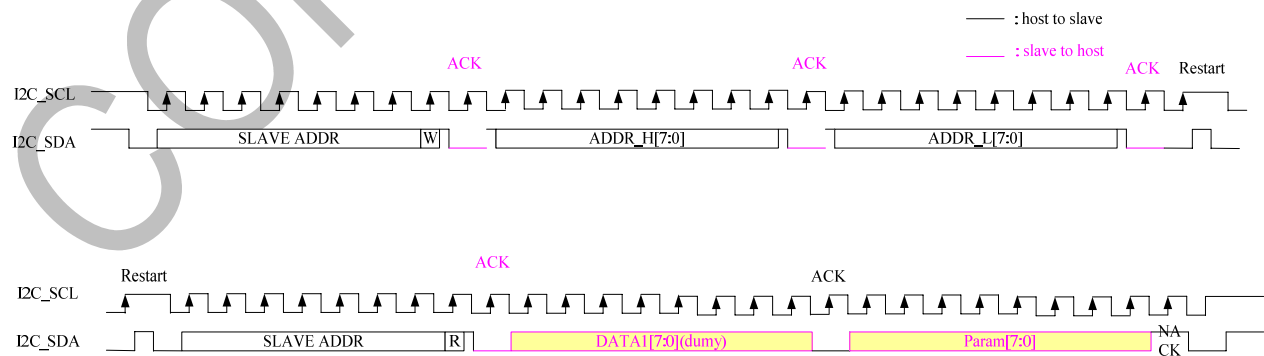

The I2C interface write data sequences are described in the following figure.

SRAM write: 65k colors, RGB 5-6-5 pixel data input (parameter of command 3A00h is 0x0005)

— : host to slave
— : slave to host (ACK)

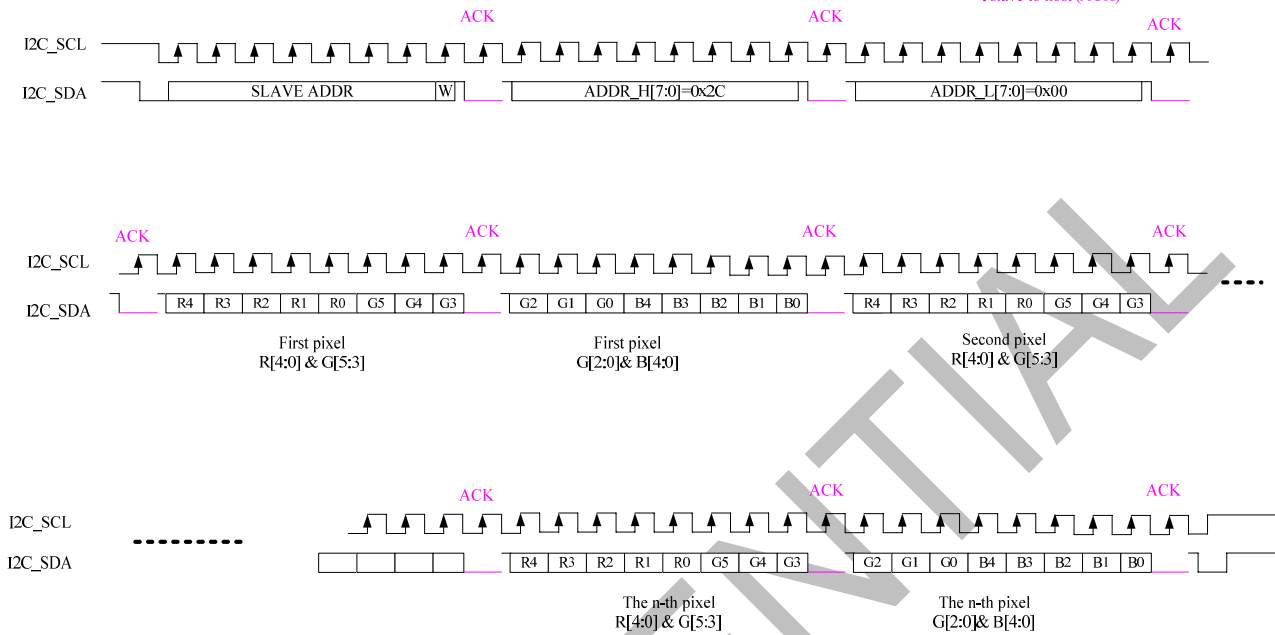

SRAM write: 262k colors, RGB 6-6-6 pixel data input (parameter of command 3A00h is 0x0006)

— : host to slave
— : slave to host (ACK)

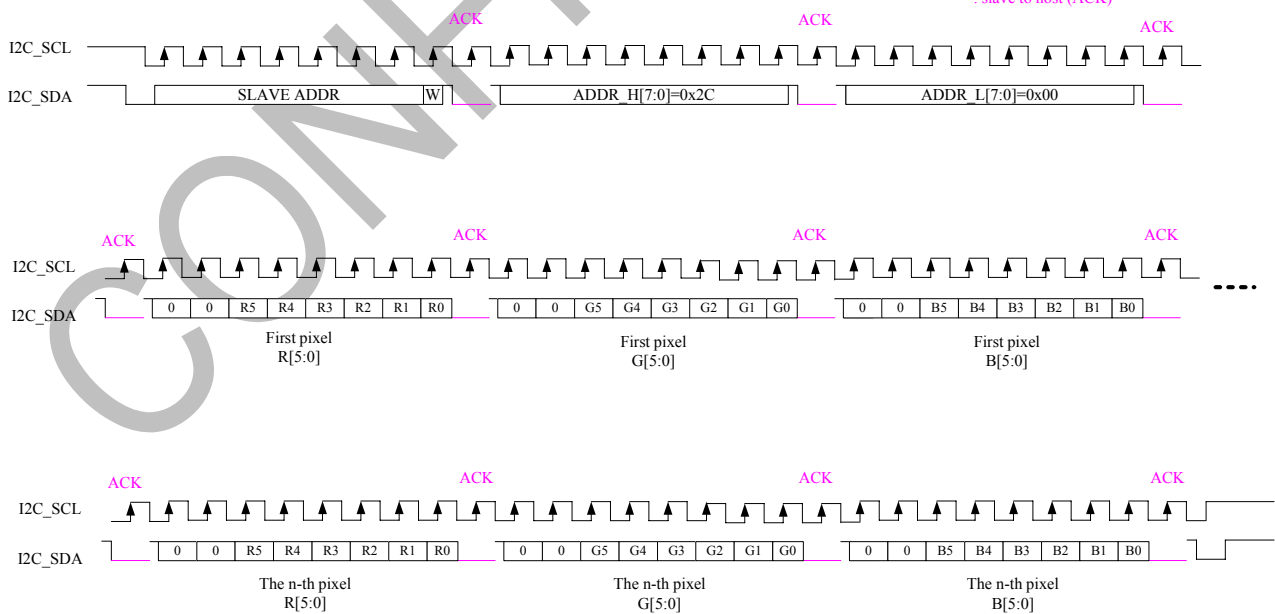

SRAM write: 16.7M colors, RGB 8-8-8 pixel data input (parameter of command 3A00h is 0x0007)

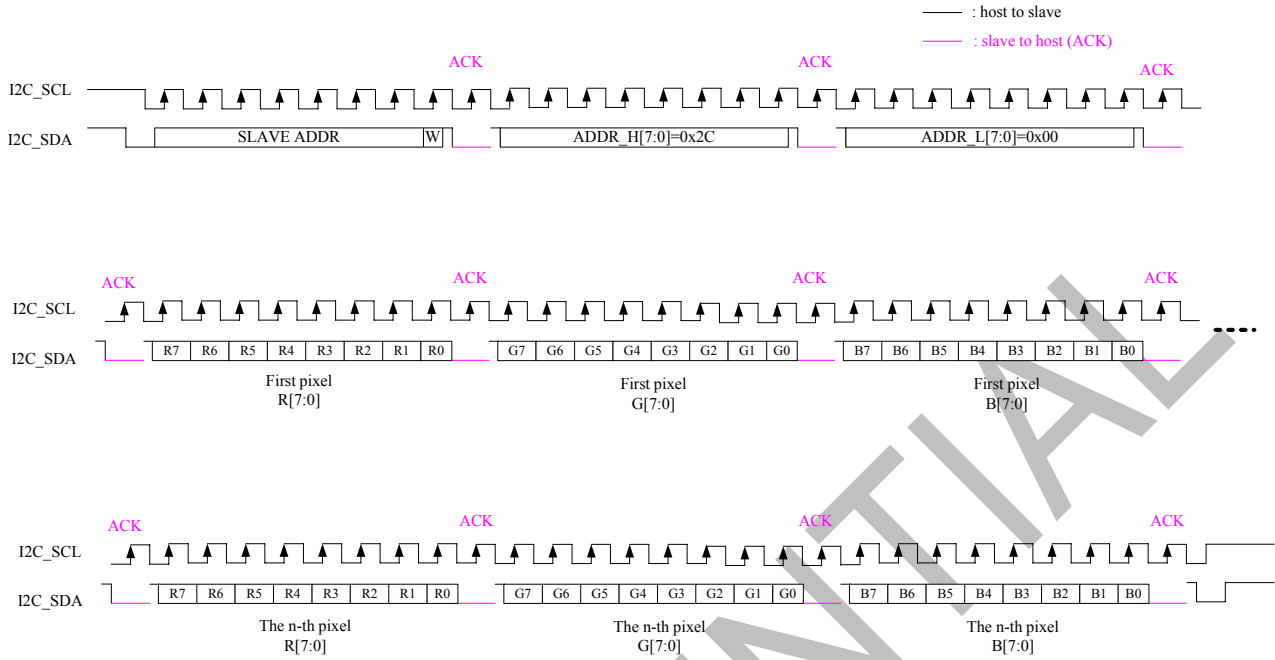

CONFIDENTIAL

The I2C interface read data sequences are described in the following figure.

SRAM read: 65k colors, RGB 5-6-5 pixel data input (parameter of command 3A00h is 0x0005)

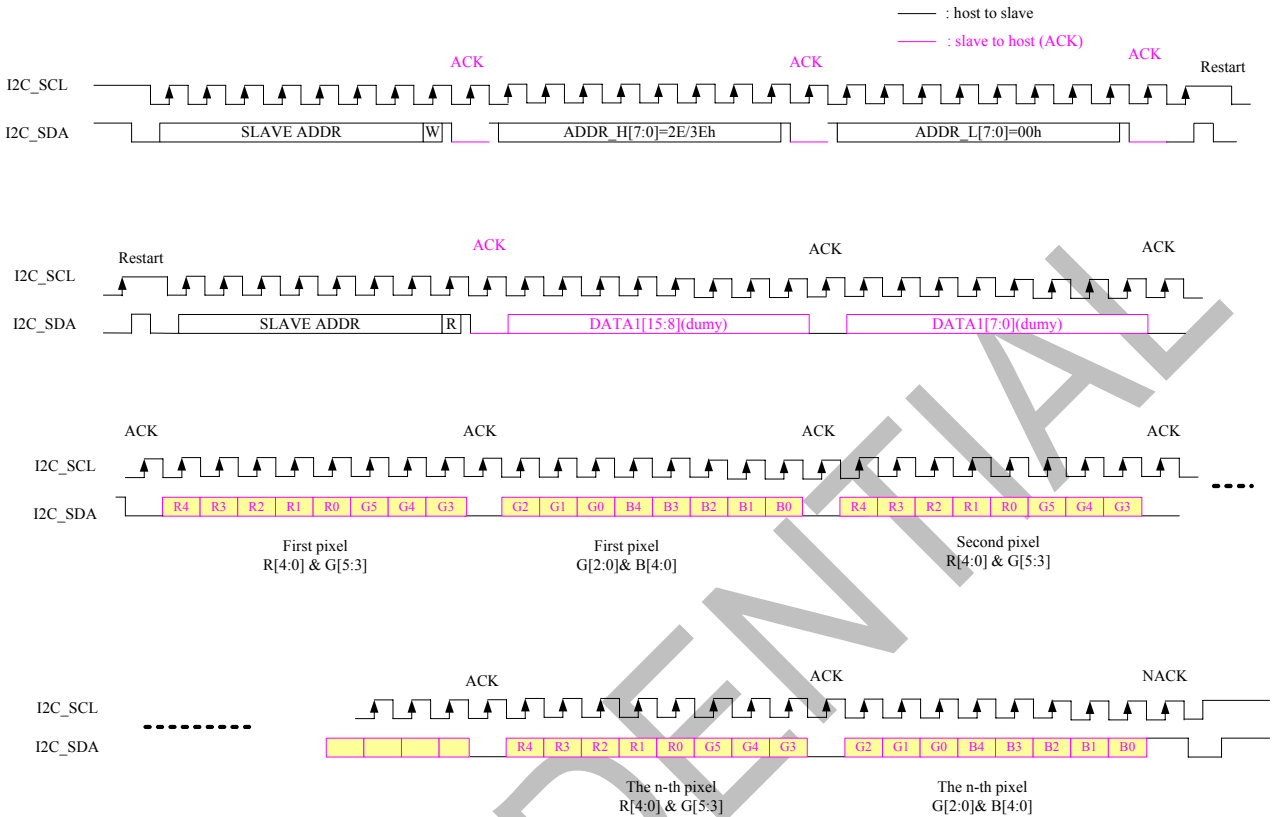

SRAM read: 262k colors, RGB 6-6-6 pixel data input (parameter of command 3A00h is 0x0006)

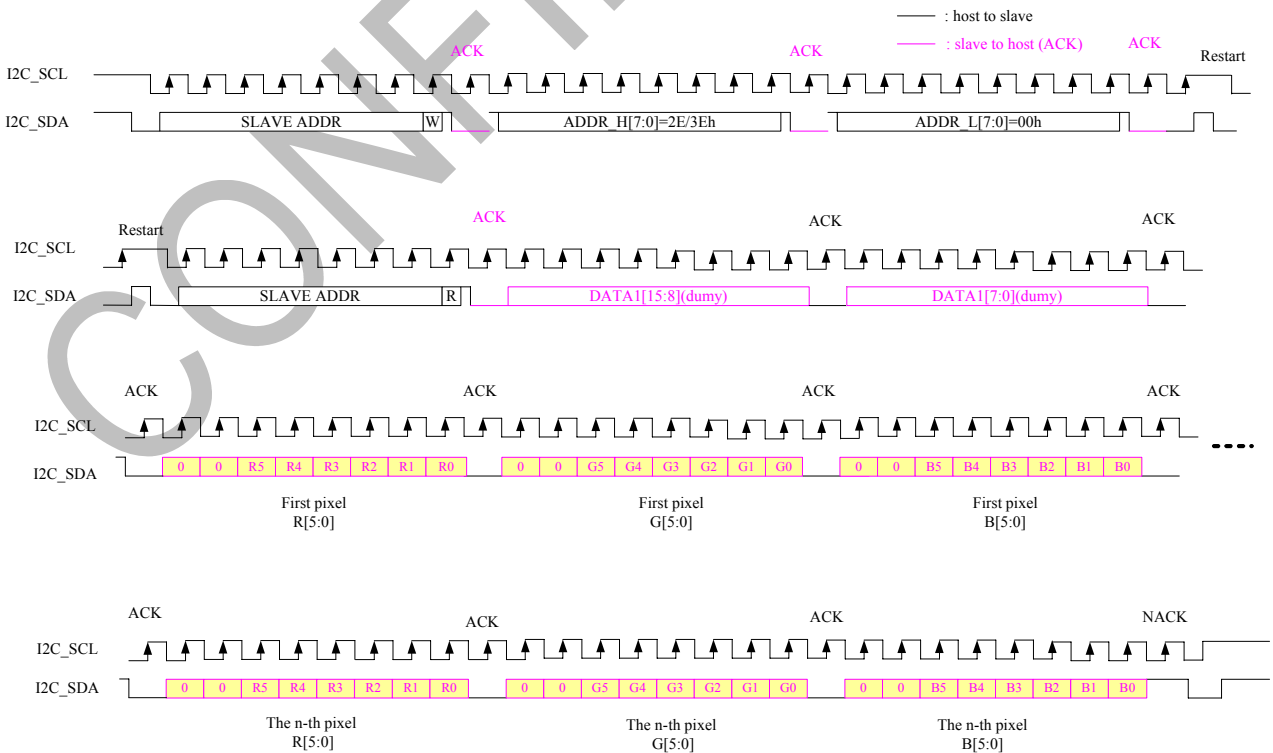

SRAM read: 16.7M colors, RGB 8-8-8 pixel data input (parameter of command 3A00h is 0x0007)

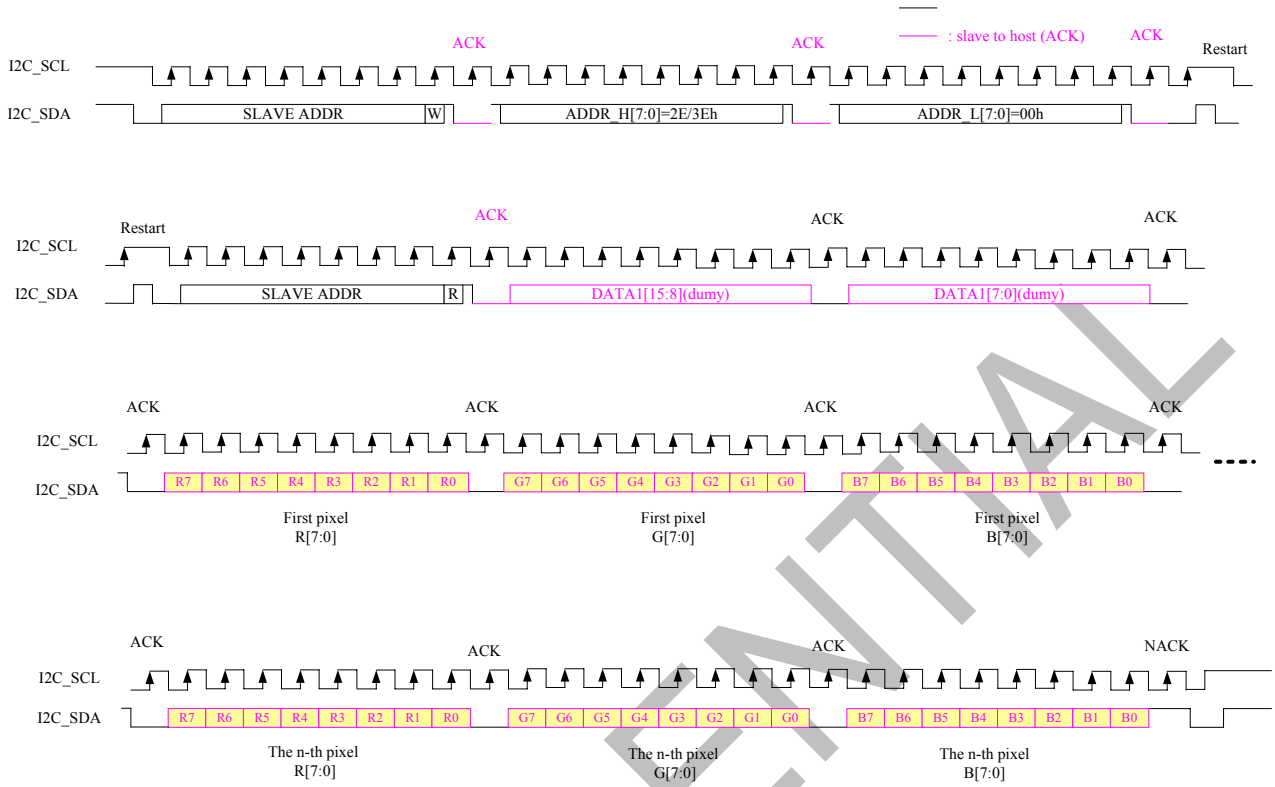

CONFIDENTIAL

7.5 Display Pixel Interface (DPI)

In normal operation, systems based on DPI architecture rely on the host processor to continuously provide complete frames of image data at a sufficient frame rate to avoid flicker or other visible artifacts. The displayed image, or frame, is comprised of a rectangular array of pixels. The frame is transmitted from the host processor to a display module as a sequence of pixels, with each horizontal line of the image data sent as a group of consecutive pixels.

Vsync indicates the beginning of each frame of the displayed image. Hsync signals the beginning of each horizontal line of pixels.

Each pixel value (16, 18 or 24-bit data) is transferred from the host processor to the display module during one pixel period. The rising edge of PCLK is used by the display module to capture pixel data. Since PCLK runs continuously, control signal DE is required to indicate when valid pixel data is being transmitted on the pixel data signals.

DPI signals are described in the follow figure.

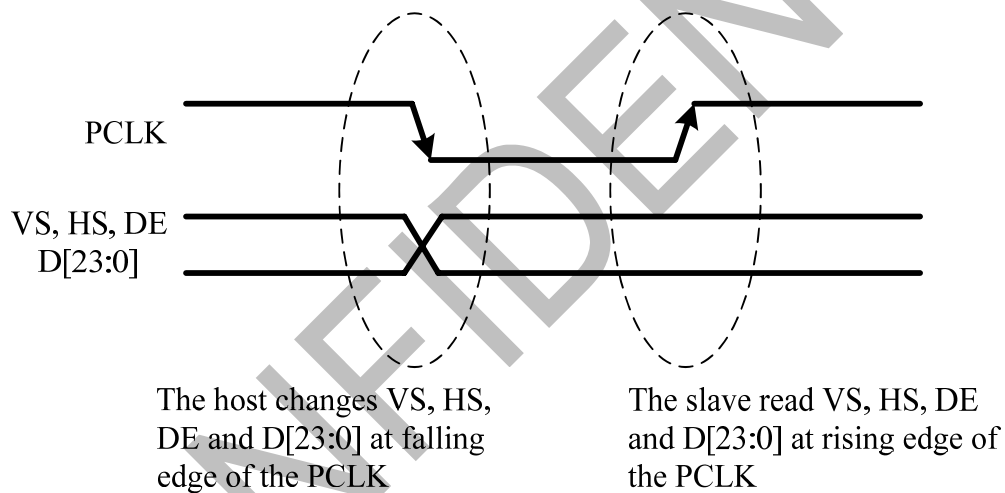

DPI Interface data bus format: (Selected by VIPF[3:0])

VIPF	DB ₂₃	DB ₂₂	DB ₂₁	DB ₂₀	DB ₁₉	DB ₁₈	DB ₁₇	DB ₁₆	DB ₁₅	DB ₁₄	DB ₁₃	DB ₁₂	DB ₁₁	DB ₁₀	DB ₉	DB ₈	DB ₇	DB ₆	DB ₅	DB ₄	DB ₃	DB ₂	DB ₁	DB ₀	color
5	/	/	/	R[4]	R[3]	R[2]	R[1]	R[0]	/	/	G[5]	G[4]	G[3]	G[2]	G[1]	G[0]	/	/	/	B[4]	B[3]	B[2]	B[1]	B[0]	65K
6	/	/	R[5]	R[4]	R[3]	R[2]	R[1]	R[0]	/	/	G[5]	G[4]	G[3]	G[2]	G[1]	G[0]	/	/	B[5]	B[4]	B[3]	B[2]	B[1]	B[0]	262K
7	R[7]	R[6]	R[5]	R[4]	R[3]	R[2]	R[1]	R[0]	G[7]	G[6]	G[5]	G[4]	G[3]	G[2]	G[1]	G[0]	B[7]	B[6]	B[5]	B[4]	B[3]	B[2]	B[1]	B[0]	16.7M

DPI Interface Timing Chart.

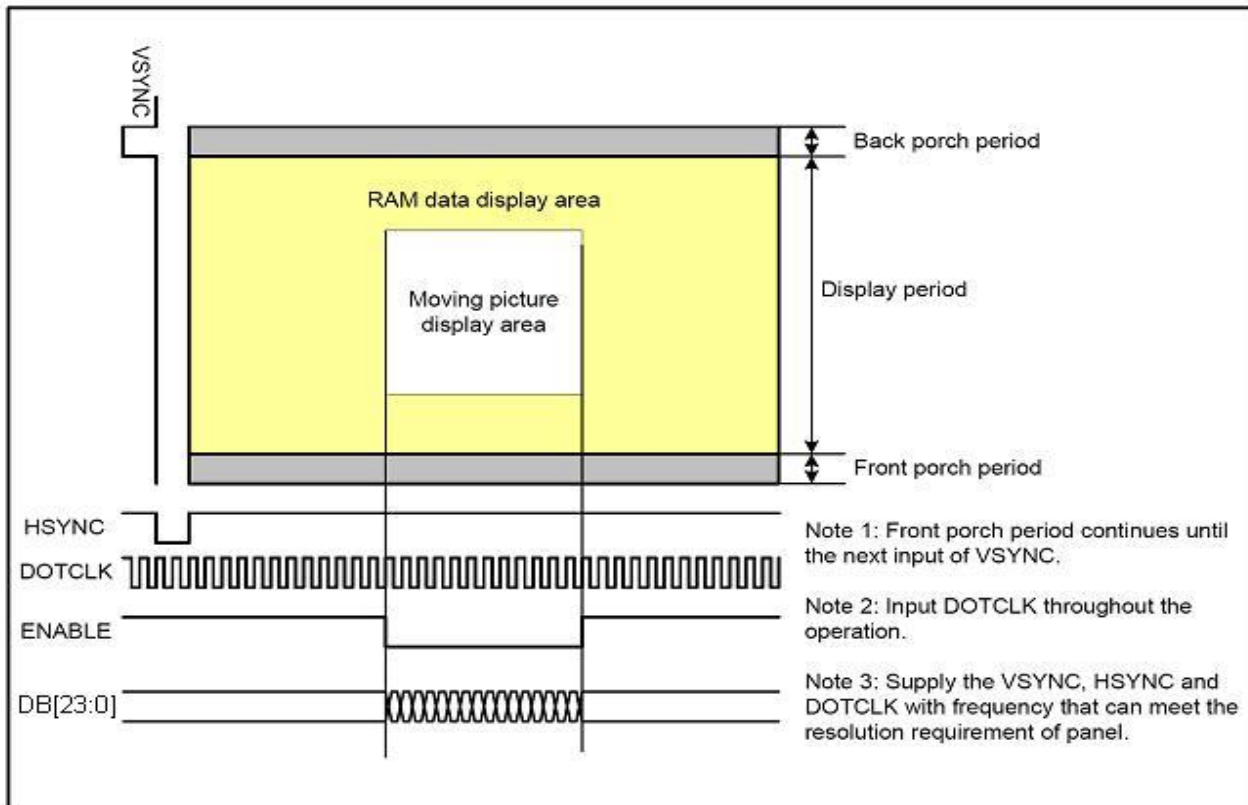
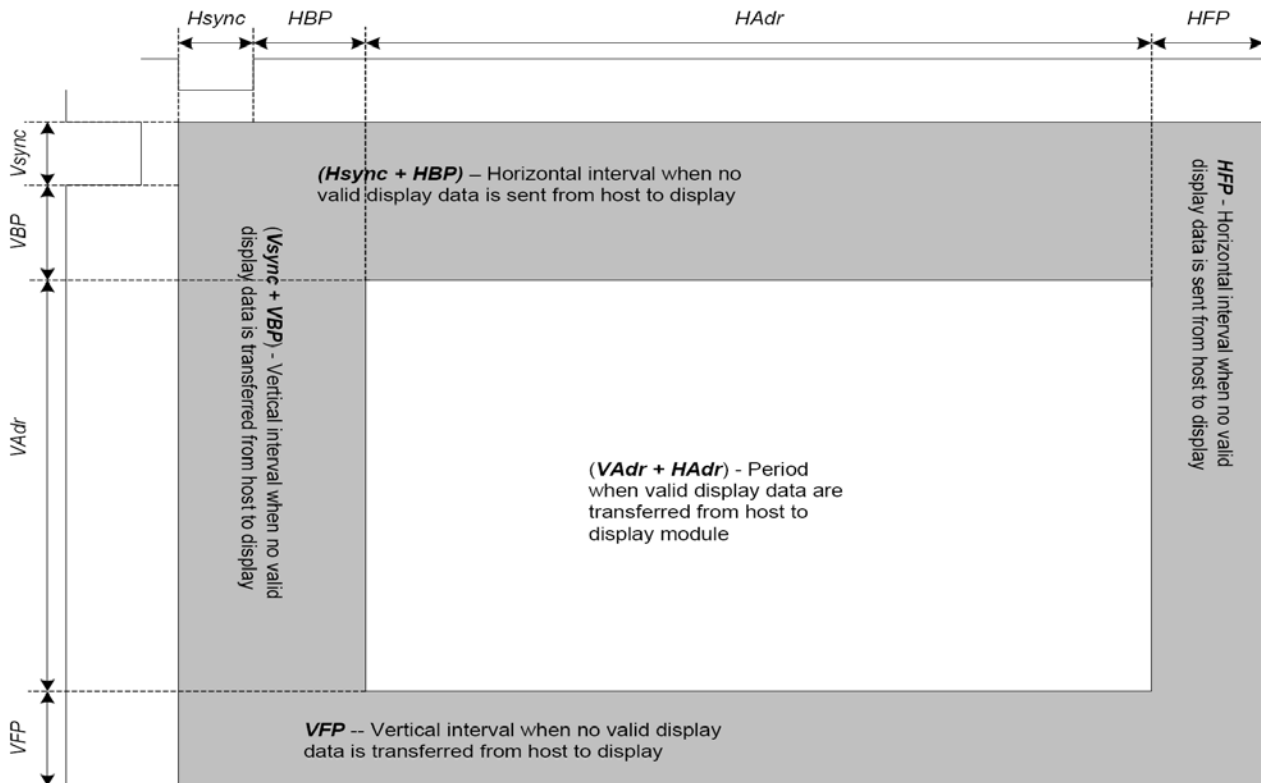

7.6 Display Serial Interface (DSI)

DSI-compliant peripherals support either of two basic modes of operation: Command Mode and Video Mode. The mode definitions reflect the primary intended use of DSI for display interconnect, but are not intended to restrict DSI from operating in other applications.

RM68120 is capable of both Command Mode operation and Video Mode operation. Command Mode refers to operation in which transactions primarily take the form of sending commands and data to a display module that incorporates a display controller. The display controller may include local registers and a frame buffer. Systems using Command Mode write to, and read from, the registers and frame buffer memory. The host processor indirectly controls activity at the peripheral by sending commands, parameters and data to the display controller. The host processor can also read display module status information or the contents of the frame memory. Command Mode operation requires a bidirectional interface. Video Mode refers to operation in which transfers from the host processor to the peripheral take the form of a real-time pixel stream. In normal operation, the display module relies on the host processor to provide image data at sufficient bandwidth to avoid flicker or other visible artifacts in the displayed image. Video information should only be transmitted using High Speed Mode. RM68120 Video Mode architectures also include a simple timing controller and partial frame buffer, used to maintain a partial-screen or lower-resolution image in standby or Low Power Mode. This permits the interface to reduce power consumption.

RM68120 Configuration:

Lane Pair	MCU(Master) RM68120(Slave)
Clock Lane	Unidirectional Lane Clock only
Data Lane 0	Bi-directional Lane ➤ Forward High-speed ➤ Bi-directional Escape Mode ➤ Bi-directional LPDT
Data Lane 1	Unidirectional Lane ➤ Forward High-Speed ➤ Escape Mode

7.6.1 DSI Protocol

On the transmitter side of a DSI Link, parallel data, signal events, and commands are converted to packets. These packets are sent across the serial Link. The receiver side of a DSI Link performs the converse of the transmitter side, decomposing the packet into parallel data, signal events and commands.

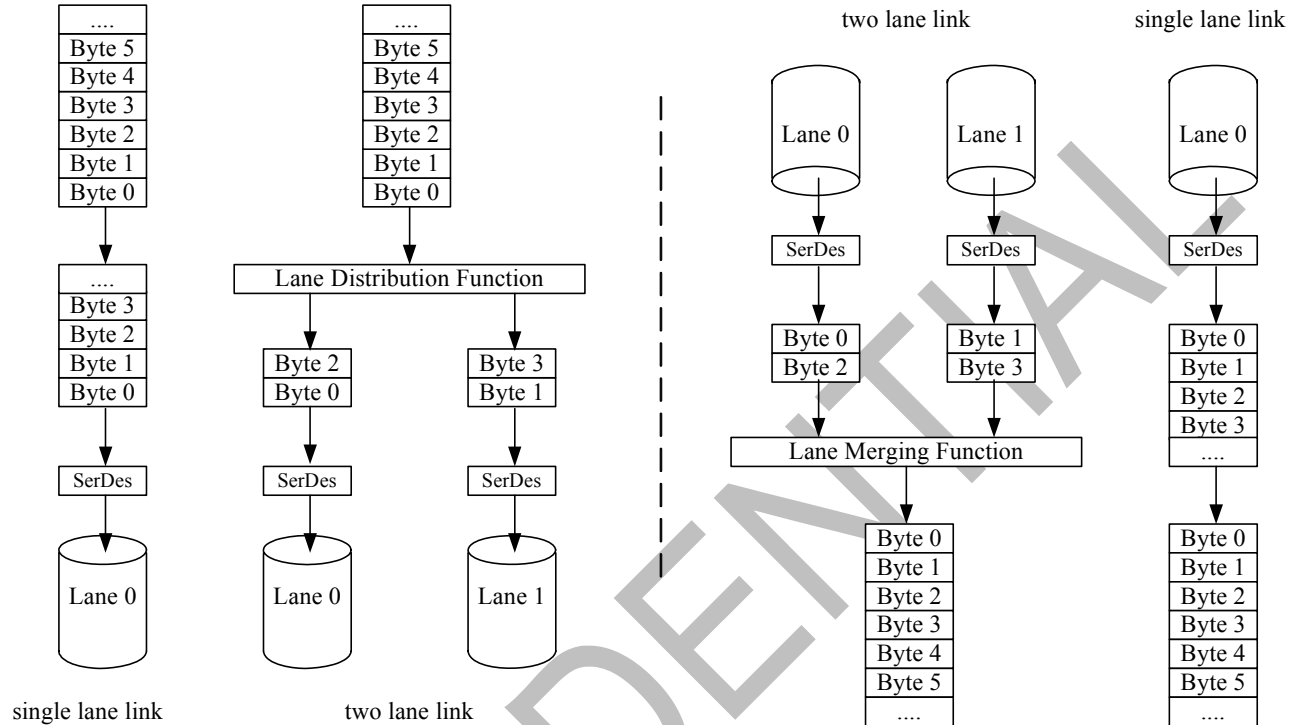

There are two kinds of packets, **short packet and long packet**.

➤ Short packet structure:

- LP-11: low power mode
- SoT: start of transmission
- DI: data identification
- Data 0, Data1: packet data
- ECC: error correction code
- EoT: End of Transmission

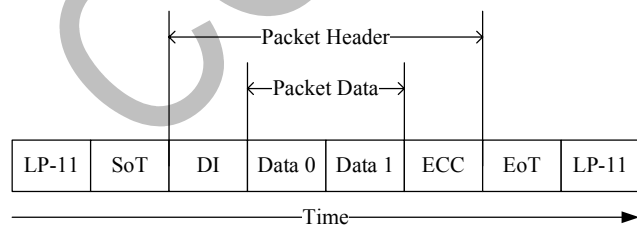

DI structure:

Virtual Channel: these two bits identify the data as directed to one of four virtual channels

Data Type: It specifies the packet structure and packet format

Virtual Channel (VC)		Data Type (DT)					
Bit 7	Bit 6	Bit 5	Bit 4	Bit 3	Bit 2	Bit 1	Bit 0

➤ Long packet structure:

LP-11: low power mode

SoT: start of transmission

DI: data identification

Word Count: the number of data bytes of packet data

ECC: error correction code

Checksum: The 16-bit CRC generator to check packet data. If the calculated checksum of receiver are equal to the packet data, the packet data is correct. If the calculated checksum of receiver are not equal, the packet data are not correct.

EoT: end of transmission

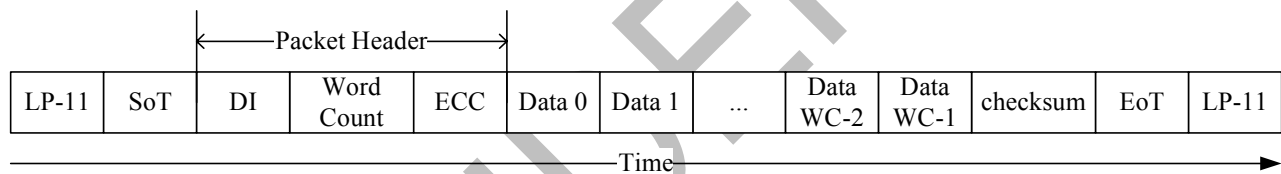

7.6.2 Processor to Peripheral Transactions

Processor to Peripheral Direction Packet Data Types

Data Type	Data Type binary	Description	Packet Size
01h	00 0001	Sync Event, V Sync Start	Short
11h	01 0001	Sync Event, V Sync End	Short
21h	10 0001	Sync Event, H Sync Start	Short
31h	11 0001	Sync Event, H Sync End	Short
08h	00 1000	End of Transmission packet (EoTp)	Short
02h	00 0010	Color Mode (CM) Off Command	Short
12h	01 0010	Color Mode (CM) On Command	Short
22h	10 0010	reserved	Short
32h	11 0010	reserved	Short
03h	00 0011	reserved	Short
13h	01 0011	Generic Short WRITE, 1 parameter	Short
23h	10 0011	Generic Short WRITE, 2 parameters	Short
04h	00 0100	reserved	Short
14h	01 0100	Generic READ, 1 parameter	Short
24h	10 0100	Generic READ, 2 parameters	Short
05h	00 0101	DCS Short WRITE, no parameters	Short
15h	01 0101	DCS Short WRITE, 1 parameter	Short
06h	00 0110	DCS READ, no parameters	Short
37h	11 0111	Set Maximum Return Packet Size	Short
09h	00 1001	Null Packet, no data	Long
19h	01 1001	Blanking Packet, no data	Long
29h	10 1001	Generic Long Write	Long
39h	11 1001	DCS Long Write/write_LUT Command Packet	Long
0Eh	00 1110	Packed Pixel Stream, 16-bit RGB, 5-6-5 Format	Long
1Eh	01 1110	Packed Pixel Stream, 18-bit RGB, 6-6-6 Format	Long
2Eh	10 1110	Loosely Packed Pixel Stream, 18-bit RGB, 6-6-6 Format	Long
3Eh	11 1110	Packed Pixel Stream, 24-bit RGB, 8-8-8 Format	Long

➤ Sync Event, Data Type = xx 0001

Sync Events are all short packets and time-accurately. They can perform like the start and end of sync pulses. To represent timing information as accurately as possible, a V Sync Start event represents the start of the VSA and also implies an H Sync Start event for the first line of the VSA. Hence, a V Sync End event implies an H Sync Start event for the last line of the VSA. Sync events may be concatenated with blanking packets to convey inter-line timing accurately and avoid the overhead of switching between LPS and HS for every event. Note there is a power penalty for keeping the data line in HS mode.

➤ EoT packet

This short packet is used to indicate the end of a high speed (HS) transmission. This packet will enhance overall system reliability. Although the main objective of the EoTp is to enhance robustness during HS transmission mode, RM68120 can detect and interpret arriving EoTps regardless of transmission mode (HS or LP modes)

➤ Color Mode Off / On Command

They are short packet commands to switch video display module between normal display mode and low-color mode for power saving.

➤ Generic short write / read packet

Generic Short WRITE command is a Short packet type for sending generic data to the peripheral. Generic READ request is a Short packet requesting data from the peripheral.

➤ DCS commands

■ DCS short write command

DCS short write command is used to write a single data byte command to display module. If there is a valid parameter byte, data type bit 4 shall be set to 1. If there is no valid parameter byte, data type bit 4 shall be set to 0 and the parameter byte shall be 00h.

■ DCS read commands

The commands are used to request data from s display module.

■ DCS Long Write / write_LUT command

The commands are used to send larger blocks of data to a display module.

■ Maximum return packet size

This command specifies the maximum size of the payload in a long packet transmission from a display module to host processor.

- Null Packet

This is a mechanism for keeping the data lane(s) in high speed mode while sending dummy data.

- Blanking Packet

A Blanking packet is used to convey blanking timing information in a Long packet. The packet represents a period between active scan lines of a Video Mode display, where traditional display timing is provided from the host processor to the display module. The blanking period may have Sync Event packets interspersed between blanking segments. Blanking packets may contain arbitrary data as payload.

- Generic Long Write

This is used to transmit arbitrary blocks of data from a host processor to a peripheral.

- Packed Pixel Stream, 16-bit Format, Data Type: 00 1110

The pixel format is five bits red, six bits green and five bits blue. The green component is split across two bytes. Within a color component, the LSB is sent first, the MSB last.

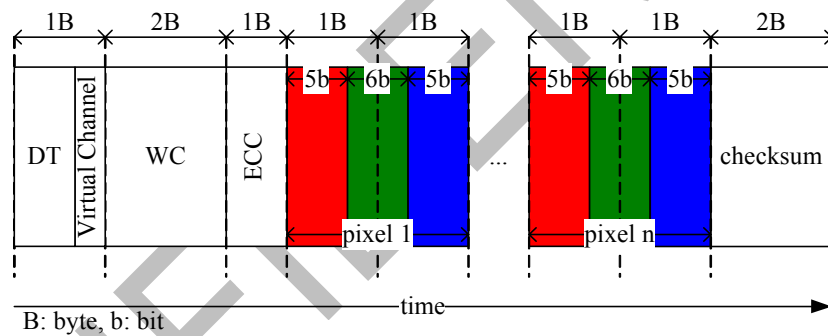

■ Packet pixel stream, 18-bit format, Data Type: 01 1110

The pixel format is six bits red, six bits green and six bits blue. Within a color component, the LSB is sent first, the MSB last.

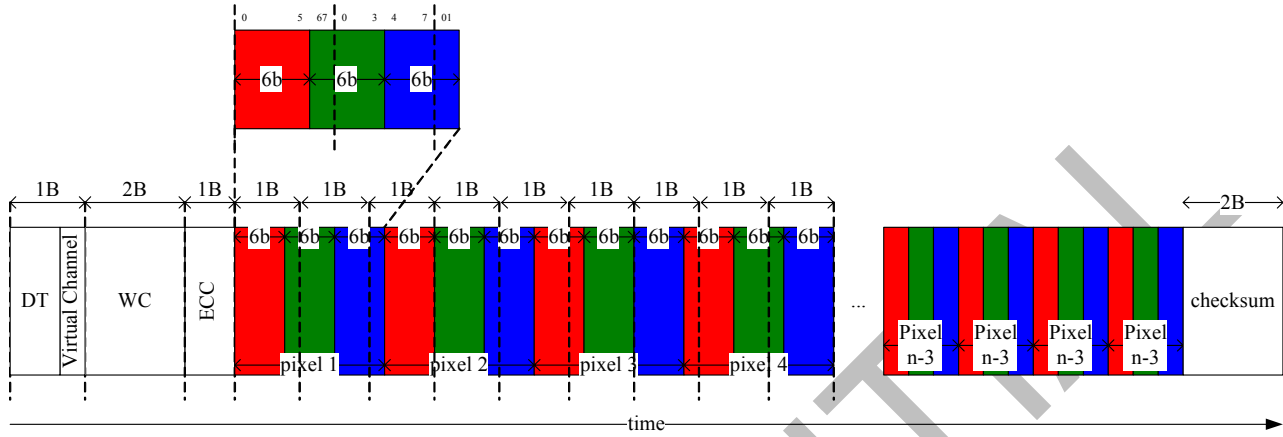

■ Packet pixel stream, 18-bit format in three bytes, Data Type: 10 1110

This is 18-bit pixel lossely packed format, each R, G or B color component is six bits but shifted to the upper bits of byte.

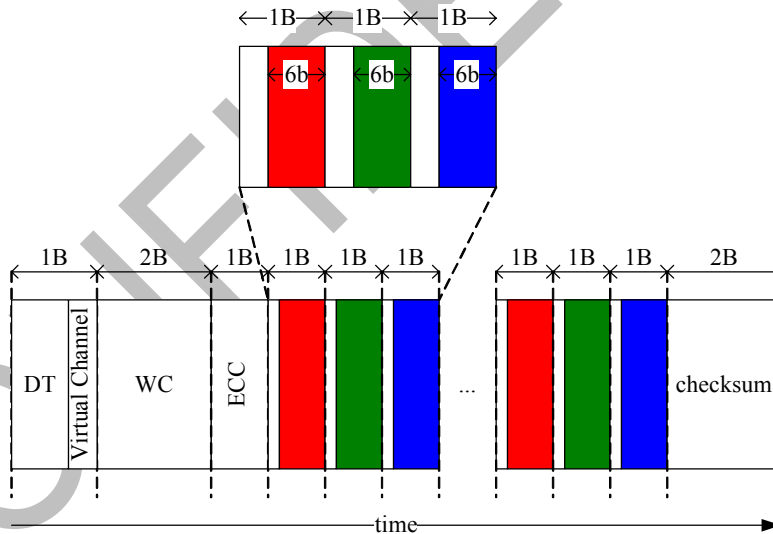

- Packet pixel stream, 24-bit format, Data Type: 11 1110

The pixel format is eight bits red, eight bits green and eight bits blue.

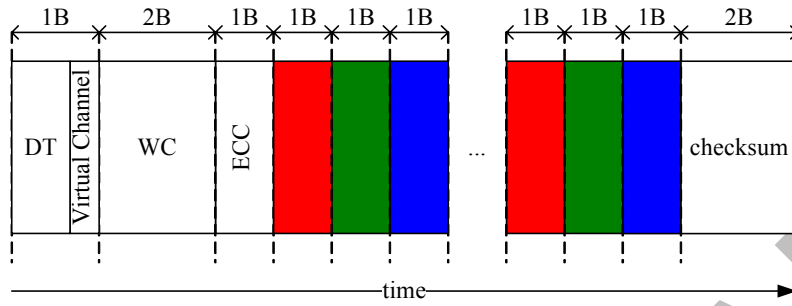

CONFIDENTIAL

7.6.3 Peripheral-to-Processor LP Transmission

All Command Mode systems require bidirectional capability for returning READ data, acknowledge, or error information to the host processor. Multi-Lane systems shall use Lane 0 for all peripheral-to-processor transmissions. Reverse-direction signaling shall only use low power mode transmission. Packet structure for peripheral-to-processor transaction is the same as for the processor-to-peripheral direction. For the processor-to-peripheral direction, two basic packet formats are the same as the peripheral-to-processor direction: Short and Long packet structure. BTA shall take place after every peripheral-to-processor transaction. This returns bus control to the host processor following the completion of the LP transmission from the peripheral.

There are four basic types of peripheral-to-processor transactions.

- Tearing Effect: It is a Trigger message sent to convey display timing information to the host processor.
- Acknowledge: It is a Trigger Message sent when the current transmission, as well as all preceding transmissions since the last peripheral to host communication.
- Acknowledge and Error Report: It is a Short packet sent if any errors were detected in preceding transmissions from the host processor.
- Response to Read Request: It may be a Short or Long packet that returns data requested by the preceding READ command from the processor.

Interpretation of processor-to-peripheral transactions with BTA asserted, and the expected responses, are as follows:

- Following a non-Read command: If no errors were detected, the peripheral shall respond with Acknowledge.
- Following a Read request: The peripheral shall send the requested READ data if no errors were detected and stored since the last peripheral to host communication.
- Following a Read request: If only a single-bit ECC error was detected and corrected, the peripheral shall send the requested READ data in a Long or Short packet and a 4-byte Acknowledge and Error Report packet in the same LP transmission.
- Following a non-Read command: If only a single-bit ECC error was detected and corrected, the peripheral shall respond to BTA by sending a 4-byte Acknowledge and Error Report packet.
- Following a Read request: If multi-bit ECC errors were detected and not corrected, the peripheral shall send a 4-byte Acknowledge and Error Report packet without sending Read data.
- Following a non-Read command: If multi-bit ECC errors were detected and not corrected, the peripheral shall not execute the command, and shall send a 4-byte Acknowledge and Error Report packet.
- Following any command: If SoT Error, SoT Sync Error, the VC of DSI or the ID of DSI Invalid or DSI protocol violation was detected, or the DSI command was not recognized, the peripheral shall send a 4-byte Acknowledge and Error Report response.
- Following any command: If EoT Sync Error or LP Transmit Sync Error is detected, or a checksum error

is detected in the payload, the peripheral shall send a 4-byte Acknowledge and Error Report packet.

Error Report Format

The following table shows the bit assignment for all error report.

Bit	Description
0	SoT Error
1	SoT Sync Error
2	EoT Sync Error
3	Escape Mode Entry Command Error
4	Low-Power Transmit Sync Error
5	HS Receive Timeout Error
6	False Control Error
7	Reserved
8	ECC Error, single-bit (detected and corrected)
9	ECC Error, multi-bit (detected, not corrected)
10	Checksum Error (Long packet only)
11	DSI Data Type Not Recognized
12	DSI VC ID Invalid
13	reserved
14	reserved
15	reserved

Peripheral-to-Processor Transaction – Detail Format Description

The following list is the complete set of peripheral-to-processor data types.

Data type, hex	Data type binary	Description	Packet size
02h	00 0010	Acknowledge and error report	short
08h	00 1000	reserved	short
11h	01 0001	GEN short read reponse, 1byte returned	short
12h	01 0010	GEN short read reponse, 2bytes returned	short
1Ah	01 1010	Generic long read reponse	long
1Ch	01 1100	DCS long read reponse	long
21h	10 0001	DCS short read reponse, 1byte returned	short
22h	10 0010	DCS short read reponse, 2bytes returned	short

- Acknowledge and error report: It is sent with BTA asserted when a reportable error is detected in the preceding, or earlier, transmission from the host processor.
- Generic Short Read Response: This is the short-packet response to Generic READ Request. Packet composition is the Data Identifier (DI) byte, two bytes of payload data and an ECC byte. If the command itself is possibly corrupt, due to an uncorrectable ECC error, SoT or SoT Sync error, the requested READ data packet shall not be sent and only the Acknowledge and Error Report packet shall be sent.
- Generic long read reponse: This is the long-packet response to Generic READ Request. Packet composition is DI followed by a two-byte Word Count, an ECC byte, N bytes of payload, and a two-byte Checksum. If the command itself is possibly corrupt, due to an uncorrectable ECC error, SoT or SoT Sync error, the requested READ data packet shall not be sent and only the Acknowledge and Error Report packet shall be sent.
- DCS long read reponse: This is a Long packet response to DCS Read Request. Packet composition is DI followed by a two-byte Word Count, an ECC byte, N bytes of payload, and a two-byte Checksum. If the DCS command itself is possibly corrupt, due to uncorrectable ECC error, SoT or SoT Sync error, the requested READ data packet shall not be sent and only the Acknowledge and Error Report packet shall be sent.
- DCS short read reponse: This is the short-packet response to DCS Read Request. Packet composition is DI, two bytes of payload data and an ECC byte. If the command itself is possibly corrupt, due to an uncorrectable ECC error, SoT or SoT Sync error, the requested READ data packet shall not be sent and only the Acknowledge and Error Report packet shall be sent.

7.6.4 Notice

1. We recommend users to stay in STOP state for 500ns when switching from LPDT to HSDT.
2. We recommend users to adopt EoTp to enhance overall robustness of the system during HSDT.

CONFIDENTIAL

7.7 MDDI Interface

The RM68120 supports the Mobile Display Digital Interface (MDDI) is a differential small amplitude serial interface for high-speed data transfer through the following lines: DATA0_P/M, DATA1_P/M and STB_P/M.

The specifications of MDDI supported by the RM68120 meet the MDDI specifications Version 1.2 as published by the Video Electronics Standards Association (VESA).

The RM68120 offers the bi-direction link to use for the register and display data read / write.

For power saving, the RM68120 offers both hibernation mode (Send shutdown packet), and enter deep standby mode to reduce power consumption.

The RM68120 supports the MDDI Type-I and Type-II of the MDDI specifications Version 1.2 and the application diagram is illustrated as follow.

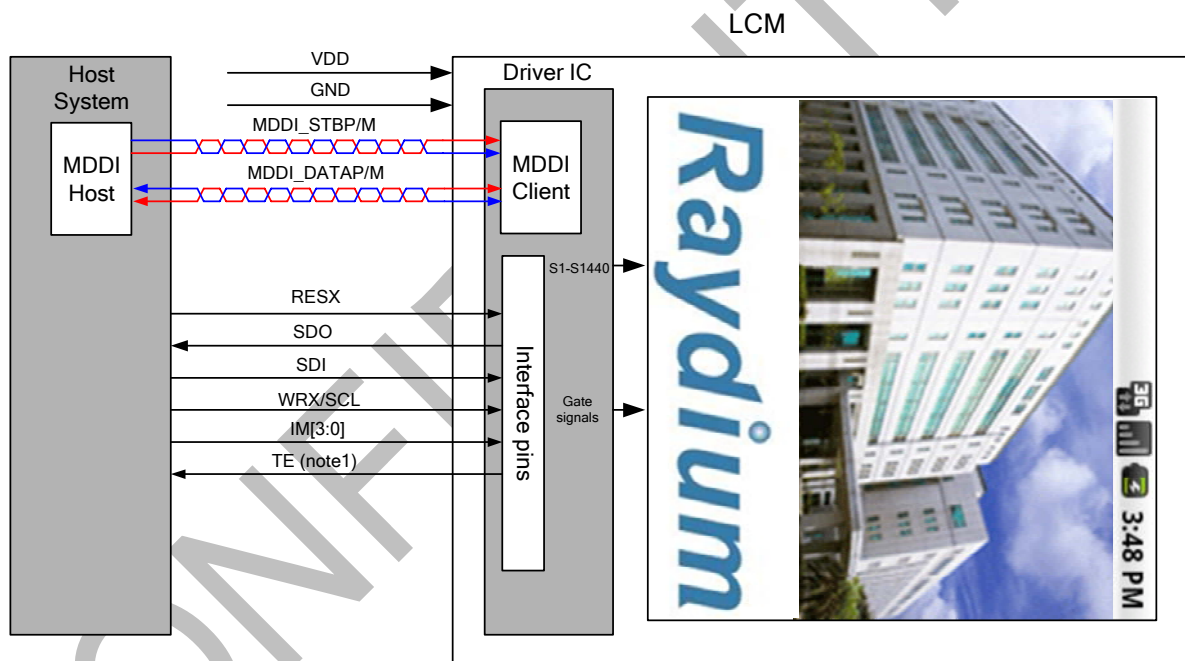

Notes:

1. Based on the system configuration, use TE signal as the reference signal for moving picture display to avoid the tearing effect.
2. When enter to the MDDI interface from other interface, the Host needs to wait 100ms and can start to send any packet. For example wake up packet.
3. After shutting down the MDDI interface the Host needs to wait 500ns and can start to send wake up packet to wake up the MDDI link.
4. The terminal resistors are embedded between MDDI_DATA0_P/M, MDDI_DATA1_P/M and MDDI_STB_P/M.

7.7.1 MDDI Link Protocol

The RM68120's MDDI Link Protocol is in accordance with the MDDI specifications as published by VESA; refer to these specifications for more information on the MDDI Link Protocol.

DO NOT send any packets that are not supported by the RM68120 into a system containing the RM68120.

Supported MDDI packets are as follows:

RM68120 MDDI packets	Packet Name	Packet Type	Direction	Supported Type
Link Control Packet	Sub-frame header packet	15359 (0x3BFF)	Forward	Type I/Type II
	Filler packet	0	Forward/Reverse	Type I/ Type II (Forward) Type I Only (Reverse)
	Link Shutdown packet	69 (0x45)	Forward	Type I/Type II
	Reverse link encapsulation packet	65 (0x41)	Forward	Type I Only
	Round-trip delay measurement packet	82 (0x52)	Forward	Type I/Type II
	Forward link skew calibration packet	82 (0x52)	Forward	Type I/Type II
Client Status and Control Packet	Client capability packet	66 (0x42)	Reverse	Type I Only
	Client request and status packet	70 (0x46)	Reverse	Type I Only
	Register access packet	146 (0x92)	Forward/Reverse	Type I/ Type II (Forward) Type I Only (Reverse)
Basic Media Stream Packet	Video stream packet	16 (0x10)	Forward	Type I/Type II
	Flexible video stream packet	20 (0x14)	Forward	Type I/Type II
	Windowless video stream packet	22 (0x16)	Forward	Type I/Type II

7.7.2 MDDI Link Packet Descriptions

Sub-frame Header Packet

The Sub-Frame Header Packet is the first packet of every sub-frame.

Sub-frame Header Packet

Packet Length	Packet Type =0x3bff	Unique word =0x005a	Reversed 1	Sub-frame Length	Protocol Version	Sub-frame Count	Media-frame Count	CRC
2 bytes	2 bytes	2 bytes	2 bytes	4 bytes	2 bytes	2 bytes	4 bytes	2 bytes

Packet Contents:

Packet Length: packet length not including the packet length field

Packet Type: packet type is 0x3bff

Unique Word: unique word is 0x005a

Reserved 1: not used (set to zero)

Sub-frame Length: specify the number of bytes per sub-frame

Protocol version: set to zero

- Bit [15:2] - Reserved for future expansion. These should be set to all zero.

- Bits[1:0] - Sub-frame operational mode

“00” – Sub-frame lengths strictly followed.

“01” – Sub-frame lengths are flexible. Sub-frame packets should be sent at the first opportunity after the sub-frame length has been transmitted.

“10” – Sub-frame lengths are unlimited. No more sub-frame packets are required to be transmitted after the first sub-Frame packet at startup.

Sub-frame Count: specify the number of sub-frame header packet

Media-frame Count: specify the number of media-frames

CRC: error check

Filler Packet

The Filler Packet is sent when no other information is available to be sent on the forward or reverse link.

Filler Packet

Packet Length	Packet Type=0	Filler Bytes (all zero recommended)	CRC
2 bytes	2 bytes	(Packet Length – 4) bytes	2 bytes

Packet Contents:

Packet Length: packet length not including the packet length field

Packet Type: packet type is 0

Filler Bytes: set to zero

CRC: error check

Link Shutdown Packet

The Link Shutdown Packet is sent from the host to the client to indicate that the MDDI data and strobe will be shut down and go into a low-power hibernation state.

Link Shutdown Packet

Packet Length	Packet Type=69	CRC	All Zero
2 bytes	2 bytes	2 bytes	(Packet Length – 4) bytes

Packet Contents:

Packet Length: packet length not including the packet length field

Packet Type: packet type is 69

CRC: error check

All Zero: set to zero (Type I: size is 16 bytes, Type II: size is 32 bytes)

Reverse Link Encapsulation Packet

Data is transferred in the reverse direction using the Reverse Link Encapsulation Packet.

Reverse Link Encapsulation Packet

Packet Length	Packet Type=65	hClient ID	Reversed Link Flags	Reverse Rate Divisor	Turn-Around 1 Length	Turn-Around 2 Length
2 bytes	2 bytes	2 bytes	1 byte	1 byte	1 byte	1 byte

Parameter CRC	All Zero 1	Turn-Around 1	Reversed Data Packets	Turn-Around 2	All Zero 2
2 bytes	8 bytes	x bytes	(Packet Length – x – y – 26) bytes	y bytes	8 bytes

Packet Contents:

Packet Length: packet length not including the packet length field

Packet Type: packet type is 65

hClient ID: set to zero

Reverse Link Flags:

- Bit 0 – 0: No packet request
1: Host needs the Client Capability Packet
- Bit 1 – 0: No packet request
1: Host needs the Client Request and Status Packet
- Bit [7:2] – set to zero

Reverse Rate Divisor: reverse data rate = reverse link data clock

Turn-Around 1 Length: the length of Turn-Around 1 is the forward link data rate

Turn-Around 2 Length: the length of Turn-Around 2 is determined by Round-trip delay of the link

Parameter CRC: error check

All zero: set to zero

Turn-Around 1: First turn-around period

Reverse Data Packets: A series of data packets transferred from the client to host

Turn-Around 2: The second turn-around period

Round-Trip Delay Measurement Packet

The Round-Trip Delay Measurement Packet is used to measure the propagation delay from the host to the client plus the delay from the client back to the host. This packet is most useful when the MDDI link is running at the maximum speed intended for a particular application. The packet may be sent in Type I mode and at a lower data rate to increase the range of the Round-Trip delay measurement.

Round Trip Measurement Packet

Packet Length	Packet Type=82	hClient ID	Parameter CRC
2 bytes	2 bytes	2 bytes	2 byte

Guard Time 1	Measurement Period	All Zero	Guard Time 2
64 bytes	64 bytes	2 bytes	64 bytes

Packet Contents:

Packet Length: packet length not including the packet length field

Packet Type: packet type is 82

hClient ID: set to zero

Parameter CRC: error check

Guard Time 1: allow overlap of the host and client

Measurement Period: a 64 bytes window to allow the client to respond

All Zero: set to zero

Guard Time 2: allow overlap of the measurement period by the client

The timing of events during the Round-Trip Delay Measurement Packet illustrates as follow.

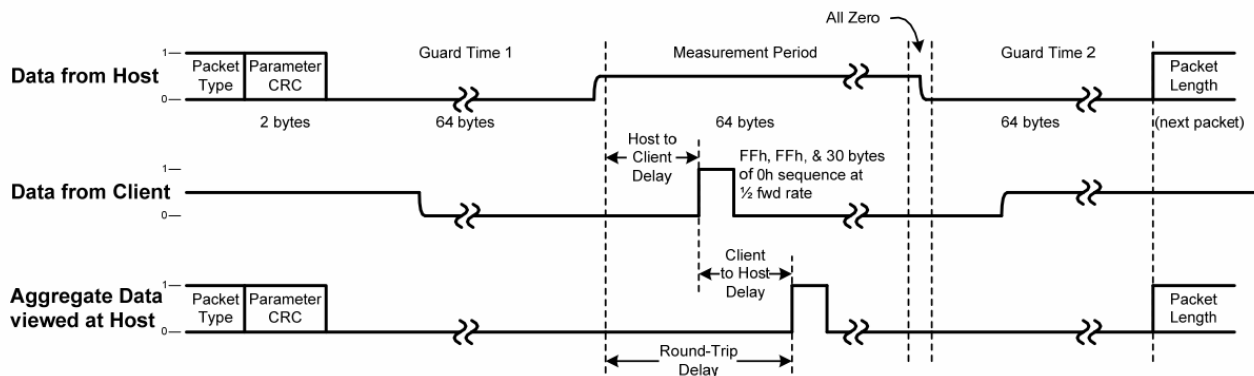

Forward Link Skew Calibration Packet

This packet allows the client to calibrate itself for differences in the propagation delay of the MDDI_DATA signals with respect to the MDDI_STB signal. Without delay skew compensation the maximum data rate must be limited to account for the worst-case variation in these delays. It is recommended that this packet only be sent when the forward link data rate is configured to 50 Mbps or lower. After sending this packet to calibrate the client the data rate may be stepped up above 50 Mbps. With the data rate set too high during the skew calibration process the client might synchronize to an alias of the bit period which would cause the delay skew compensation setting to be off by more than one bit time, resulting in erroneous data clocking. The greatest possible Interface Type must be selected prior to sending the Forward Link Skew Calibration Packet so that all existing data bits are calibrated. The client must indicate its ability to support the Forward Link Skew Calibration Packet via bit 19 of Client Feature Capability Indicators field of the Client Capability Packet.

Prior to performing skew calibration the host must not send data faster than the rate specified by the Pre-calibration Data Rate Capability field of the Client Capability Packet. However, after calibration is performed, the host may send data up to the rate defined by the Post-calibration Data Rate Capability field. It is recommended that the host send the Forward Link Skew Calibration Packet at regular intervals to correct

changes in the relative delay between the different signal pairs due to changes in temperature.

Forward Link Skew Calibration Packet

Packet Length	Packet Type=83	hClient ID	Parameter CRC	All Zero 1	Calibration Data Sequence	All Zero 2
2 bytes	2 bytes	2 bytes	2 bytes	2 bytes	Pacet Length – 22 bytes	2 bytes

Packet Contents:

Packet Length: packet length not including the packet length field

Packet Type: packet type is 83

hClient ID: set to zero

Parameter CRC: error check from packet length to the hClient ID.

All Zero 1:

8 bytes that contain eight 8-bit unsigned integers equal to zero. This field ensures that there will be a transition on MDDI_STB at the beginning of the Calibration Data Sequence field. It also provides sufficient time for the client core logic to change the mode of the clock recovery circuit from using the XOR of MDDI_Data0 and MDDI_STB to simply using MDDI_STB as the recovered clock.

Calibration Data Sequence:

a data sequence that causes the MDDI_Data signals to toggle at every data period. The length of the Calibration Data Sequence field is determined by the interface type being used on the forward link. During the Calibration Data Sequence the MDDI host controller sets all MDDI_Data signals equal to the strobe signal. The client clock recovery circuit must use only MDDI_STB rather than MDDI_STB XOR MDDI_Data0 to recover the data clock while the Calibration Data Sequence field is being received by the client.

Depending on the exact phase of MDDI_STB at the beginning of the Calibration Data Sequence field the Calibration Data Sequence will be one of the following based on the interface Type being used when this packet is sent:

- Type 1 – (64 byte data sequence) AAh, AAh ... or 55h, 55h...
- Type 2 – (128 byte data sequence) CCh, CCh ... or 33h, 33h...

All Zero 2:

8 bytes that contain eight 8-bit unsigned integers equal to zero. This field provides sufficient time for the client core logic to change the mode of the clock recovery circuit back to the original state, from using MDDI_STB as the recovered clock to using the XOR of MDDI_Data0 and MDDI_STB.

Client Capability Packet

It is recommended that the client send a Client Capability Packet to the host after forward link

synchronization is acquired, and it is required when requested by the host via the Reverse Link Flags in the Reverse Link Encapsulation Packet.

Client Capability Packet

Packet Length	Packet Type=66	cClient ID	Protocol Version	Min Protocol Version	Pre-calibration Data Rate Capability	Interface Type Capability
2 bytes	2 bytes	2 bytes	2 bytes	2 bytes	2 bytes	1 byte
Number of Alt Display	Post-calibration Data Rate Capability	Bitmap Width	Bitmap Height	Display Window Width	Display Window Height	Color Map Size
1 byte	2 bytes	2 bytes	2 bytes	2 bytes	2 bytes	4 bytes
Color Map RGB Width	RGB Capability	Monochrome Capability	Reversed 1	Y Cb Cr Capability	Bayer Capability	Reversed 2
2 bytes	2 bytes	1 byte	1 byte	2 bytes	2 bytes	2 bytes
Client Feature Capability	Max Video Frame Rate	Min Video Frame Rate	Min Sub-frame Rate	Audio Buffer Depth	Audio Channel Capability	Audio Sample Rate Capability
4 bytes	1 byte	1 byte	2 bytes	2 bytes	2 bytes	2 bytes
Audio Sample Resolution	Mic Sample Resolution	Mic Sample Rate Capability	Keyboard Data Format	Pointing Device Data Format	Content Protection Type	Mfr Name
1 byte	1 byte	2 bytes	1 byte	1 byte	2 bytes	2 bytes
Product Code	Reversed 3	Serial Number	Week of Mfr	Year of Mfr	CRC	
2 bytes	2 bytes	4 bytes	1 byte	1 byte	2 bytes	

Packet Contents:

Packet Length: packet length not including the packet length field

Packet Type: packet type is 66

cClient ID: set to zero

Protocol Version: set to 0002h

Min Protocol Version: specify the minimum protocol version (0001h)

Pre-Calibration Data Rate Capability: specify the maximum data rate the client can receive (190h)

Interface Type Capability: Client can function in Type 2 (2-bit) mode on the forward link (01h)

Number of Alt Displays: set to zero

Post-Calibration Data Rate Capability: specify the maximum data rate the client can receive (190h)

Bitmap Width: specify the width of the bitmap (1E0h)
Bitmap Height: specify the height of the bitmap (320h)
Display Window Width: specify the width of the display window (1E0h)
Display Window Height: specify the height of the display window (320h)
Color Map Size: set to zero
Color Map RGB Width: set to zero
RGB Capability: specify the resolution of RGB format (0888h)
Monochrome Capability: set to zero
Reserved 1: set to zero
Y Cb Cr Capability: set to zero
Bayer Capability: set to zero
Reserved 2: set to zero
Client Feature Capability Indicators: 00CC8000h
Maximum Video Frame Rate Capability: specify the maximum video frame (3Ch)
Minimum Video Frame Rate Capability: specify the minimum video frame (3Ch)
Minimum Sub-frame Rate: specify the minimum sub-frame rate (00h)
Audio Buffer Depth: set to zero
Audio Channel Capability: set to zero
Audio Sample Rate Capability: Set to zero
Audio Sample Resolution: set to zero
Mic Audio Sample Resolution: set to zero
Mic Sample Rate Capability: set to zero
Keyboard Data Format: set to zero
Pointing Device Data Format: set to zero
Content Protection Type: set to zero
Mfr Name: set to 0000h
Product Code: set to 6812h
Reserved 3: set to zero
Serial Number: set to zero
Week of Manufacture: set to zero
Year of Manufacture: 00h
CRC: error check

Client Request and Status Packet

The host needs a small amount of information from the client so it can configure the host-to-client link in an optimum manner. The Client Request and Status Packet is required to report errors and status to the host.

Client Request and Status Packet

Packet Length	Packet Type=70	cClient ID	Reverse Link Request	CRC Error Count	Client Status	Client Busy Flags	CRC
2 bytes	2 bytes	2 bytes	2 bytes	1 byte	1 byte	2 bytes	2 bytes

Packet Contents:

Packet Length: packet length not including the packet length field

Packet Type: packet type is 70

cClient ID: set to zero

Reverse Link Request: specify the number of bytes the client needs in the reverse link in the next sub-frame to send information to the host.

CRC Error Count: count the number of CRC errors occurred

Client Status:

- Bit 0 - 1: capability has changed
0: capability has not changed
- Bit 1 - indicates the client has detected an error
- Bit [7:2] - set to zero

Client Busy Flags:

- Bit 0 - bitmap block transfer function is busy
- Bit 1 - bitmap area fill function is busy
- Bit 2 - bitmap pattern fill function is busy
- Bit 3 - the graphics subsystem is busy
- Bit [15:4] - set to zero

CRC: error check

Register Access Packet

Register Access Packet is utilized when setting instruction to the RM68120. This packet cannot be used for RAM access.

Register Access Packet

Packet Length	Packet Type=146	bClient ID	Read/Write Info	Register Address	Parameter CRC	Register Data List	Register Data CRC
2 bytes	2 bytes	2 bytes	2 bytes	4 bytes	2 bytes	(Packet Length -14) bytes	2 bytes

Packet Contents:

Packet Length: packet length not including the packet length field

Packet Type: packet type is 146

bClient ID: set to zero

Read/Write Info:

Bits[15:14]	Read/Write Flags
00	Write
01	Reserved
10	Read
11	Response to read

Bit [13:0] – specifies the number of 32-bit register data list items to be transferred in the Register Data List Filed.

Register Address: upper bits shall set to zero

Parameter CRC: error check from packet length to the register address

Register Data List: written (or read) registers to (from) client

Register Data CRC: error check of the register data list

Video Stream Packet

The RM68120 supports the Video Stream Packet to transfer display data including RGB data to RAM.

Video Stream Packet

Packet Length	Packet Type=16	bClient ID	Video Data Format Desriptor	Pixel Data Attributes	X Left Edge	Y Top Edge
2 bytes	2 bytes	2 bytes	2 bytes	2 bytes	2 bytes	2 bytes

X Right Edge	Y Bottom Edge	X Start	Y Start	Pixel Count	Parameter CRC	Pixel Data	Pixel Data CRC
2 bytes	2 bytes	2 bytes	2 bytes	2 bytes	2 bytes	(Packet Length -26) bytes	2 bytes

Packet Contents:

Packet Length: packet length not including the packet length field

Packet Type: packet type is 16

bClient ID: set to zero

Video Data Format Descriptor

[15:12]	[11:18]	[7:4]	[3:0]	Transfer pixel format
0101	0x8	0x8	0x8	Packed 24 bits pixel RGB format (R:G:B=8:8:8)
0101	0x6	0x6	0x6	Packed 18 bits pixel RGB format (R:G:B=6:6:6)
0101	0x5	0x6	0x5	Packed 16 bits pixel RGB format (R:G:B=5:6:5)
Others setting disabled				

Pixel Data Attributes: The pixel data is written to RAM buffer of RM68120 (00C3h)

X Left Edge: Specify the X coordinate of the left edge of the screen window filled by the Pixel Data field.

Y Top Edge: Specify the Y coordinate of the top edge of the screen window filled by the Pixel Data field

X Right Edge: Specify the X coordinate of the right edge of the window being updated.

Y Bottom Edge: Specify the Y coordinate of the bottom edge of the window being updated.

X Start: Specify X start address for the first pixel in the Pixel Data field below.

Y Start: Specify Y start address for the first pixel in the Pixel Data field below.

Pixel Count: specify the number of pixels

Parameter CRC: error check from packet length to the pixel count

Pixel Data: the raw video data

Pixel Data CRC: error check of the pixel data

Pixel Data Format

MDDI data byte	D7	D6	D5	D4	D3	D2	D1	D0	Color	
RGB 5:6:5	Byte n	G2	G1	G0	B4	B3	B2	B1	B0	65-Color (1 pixel/ 16 bits RGB format)
	Byte n+1	R4	R3	R2	R1	R0	G5	G4	G3	
RGB 6:6:6	Byte n	G1	G0	B5	B4	B3	B2	B1	B0	262K-Color (1 pixel/ 18 bits RGB format)
	Byte n+1	R3	R2	R1	R0	G5	G4	G3	G2	
	Byte n+2	B5	B4	B3	B2	B1	B0	R5	R4	
RGB 8:8:8	Byte n	B7	B6	B5	B4	B3	B2	B1	B0	16.7M-Color (1 pixel/ 24 bits RGB format)
	Byte n+1	G7	G6	G5	G4	G3	G2	G1	G0	
	Byte n+2	R7	R6	R5	R4	R3	R2	R1	R0	

Flexible Video Stream Packet

The RM68120 supports the Flexible Video Stream Packet to transfer display data including RGB data to RAM. This allows for a reduction in the number of fields sent in an environment where one or more fields are

not changing values.

Flexible Video Stream Packet

Packet Length	Packet Type=20	bClient ID	Field Present Flags	Video Data Format Description	Pixel Data Attributes	X Left Edge	Y Top Edge
2 bytes	2 bytes	2 bytes	2 bytes	2 bytes	2 bytes	2 bytes	2 bytes
X Right Edge	Y Bottom Edge	X Start	Y Start	Pixel Count	Parameter CRC	Pixel Data	Pixel Data CRC
2 bytes	2 bytes	2 bytes	2 bytes	2 bytes	2 bytes	Packet Length – present header bytes	2 bytes

Packet Contents:

Packet Length: packet length not including the packet length field

Packet Type: packet type is 20

bClient ID: set to zero

Field Present Flags: indicates the field in the packet is present (value "1") or not present (value "0").

- Bit 0: indicates the presence of the Video Data Format Description Field.
- Bit 1: indicates the presence of the Pixel Data Attributes Field.
- Bit 2: indicates the presence of the X Left Edge Field.
- Bit 3: indicates the presence of the Y Top Edge Field.
- Bit 4: indicates the presence of the X Right Edge Field.
- Bit 5: indicates the presence of the Y Bottom Edge Field.
- Bit 6: indicates the presence of the X Start Field.
- Bit 7: indicates the presence of the Y Start Field.
- Bit 8: indicates the presence of the Pixel Count Field.
- Bits [15:9] are all "0".

Video Data Format Descriptor

[15:12]	[11:18]	[7:4]	[3:0]	Transfer pixel format
0101	0x8	0x8	0x8	Packed 24 bits pixel RGB format (R:G:B=8:8:8)
0101	0x6	0x6	0x6	Packed 18 bits pixel RGB format (R:G:B=6:6:6)
0101	0x5	0x6	0x5	Packed 16 bits pixel RGB format (R:G:B=5:6:5)
Others setting disabled				

X Left Edge: Specify the X coordinate of the left edge of the screen window filled by the Pixel Data field.

Y Top Edge: Specify the Y coordinate of the top edge of the screen window filled by the Pixel Data field

X Right Edge: Specify the X coordinate of the right edge of the window being updated.

Y Bottom Edge: Specify the Y coordinate of the bottom edge of the window being updated.

X Start: Specify X start address for the first pixel in the Pixel Data field below.

Y Start: Specify Y start address for the first pixel in the Pixel Data field below.

Pixel Data Attributes: The pixel data is written to RAM buffer of RM68120 (00C3h)

Pixel Count: specify the number of pixels

Parameter CRC: error check from packet length to the pixel count

Pixel Data: the raw video data

Pixel Data CRC: error check of the pixel data

Windowless Video Stream Packet

The RM68120 supports the Windowless Video Stream Packet to transfer display data including RGB data to RAM. This packet type assumes that full screen updates are always occurring and therefore there is no need for the window information.

Windowless Video Stream Packet

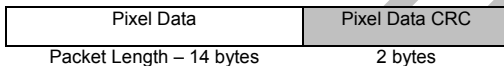
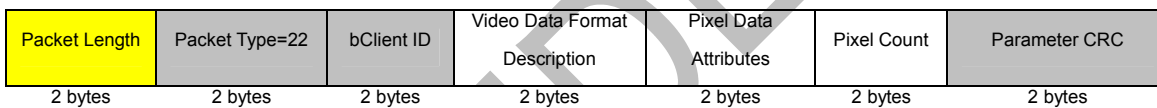

Packet Contents:

Packet Length: packet length not including the packet length field

Packet Type: packet type is 22

bClient ID: set to zero

Video Data Format Descriptor

[15:12]	[11:18]	[7:4]	[3:0]	Transfer pixel format
0101	0x8	0x8	0x8	Packed 24 bits pixel RGB format (R:G:B=8:8:8)
0101	0x6	0x6	0x6	Packed 18 bits pixel RGB format (R:G:B=6:6:6)
0101	0x5	0x6	0x5	Packed 16 bits pixel RGB format (R:G:B=5:6:5)
Others setting disabled				

Pixel Data Attributes: The pixel data is written to RAM buffer of RM68120 (00C3h)

Pixel Count: specify the number of pixels

Parameter CRC: error check from packet length to the pixel count

Pixel Data: the raw video data

Pixel Data CRC: error check of the pixel data

CONFIDENTIAL

7.7.3 Writing Video Data to Memory Sequence

In order to write video data to memory, the following sequence should be programmed. This packet should be followed by video stream packets.

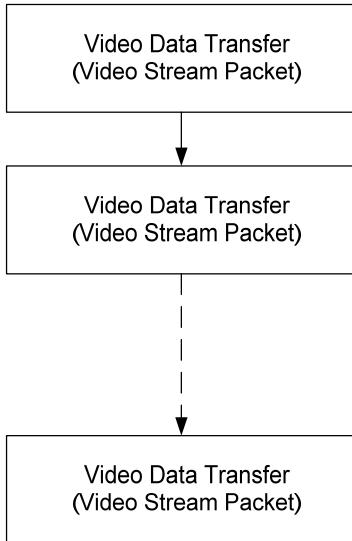

Writing Video Data to Memory Sequence

CONFIDENTIAL

7.7.4 Writing Register Sequence

In order to write registers, register access packet should be used. Register access packet is used to write data to register.

Writing Register Sequence:

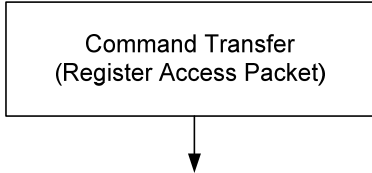

7.7.5 Reading Video Data from Memory Sequence

In order to read a pixel data from memory (readable one pixel only), the following sequence should be programmed. Memory read command (2E00h) is followed by reverse encapsulation packet. DDI transmits video pixel data through encapsulation packet. Please refer to VESA spec for detailed description.

Reading Video Data from Memory Sequence:

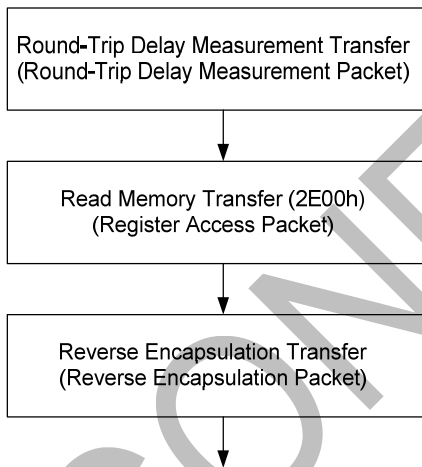

Notes:

1. X addresses for memory data read is set by 2A00h and 2A01h (XS[15:0]).

The parameters of 2A00h and 2A01h are stored on relative registers while command 2A00h~2A03h are executed completely. See also section “6.1 User Command Set” and Note 2.

2. Y addresses for memory data read is set by 2B00h and 2B01h (YS[15:0]).

The parameters of 2B00h and 2B01h are stored on relative registers while command 2B00h~2B03h are executed completely. See also section “6.1 User Command Set” and Note 2.

7.7.6 Reading Register Sequence

In order to read registers, the following sequence should be programmed. Next, register read command is followed by reverse encapsulation packet. DDI transmits register data through encapsulation packet. Please refer to VESA spec for detailed description.

Reading Register Sequence:

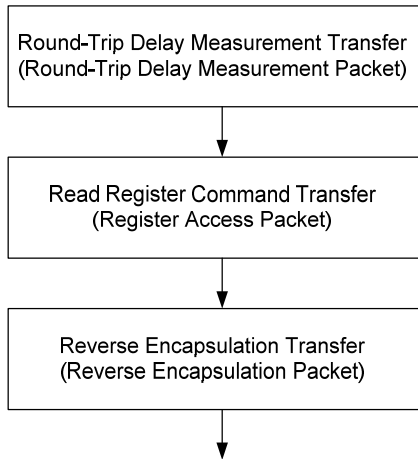

7.7.7 Hibernation Setting

The Client MDDI of the RM68120 provides a hibernation setting. The methods for waking up the hibernation mode can be determined based on actual usage.

Wake-up	Condition
Host-Initiated Wake-up	Wake up the MDDI link by MDDI Host

Note: In the Hibernation state, the data is retained in RAM and the display operation is maintained.

Hibernation setting and wake-up sequence must in accordance with VESA-MDDI specifications.

Hibernation setting sequence

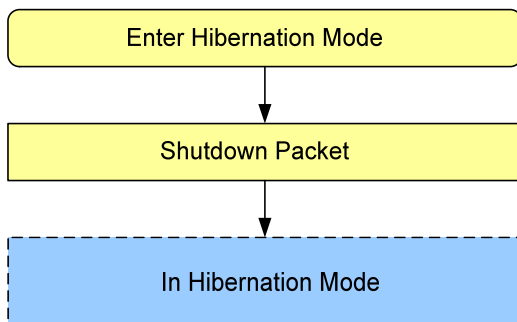

Hibernation Wake-up sequence

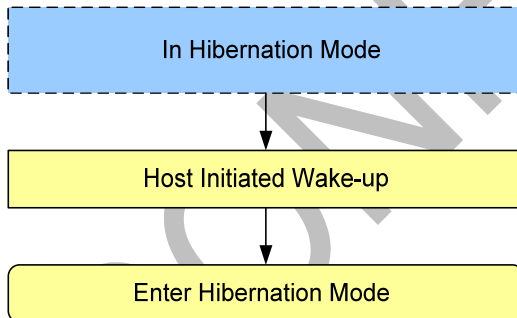

7.7.8 MDDI Deep Standby Mode Setting

The Client MDDI of the RM68120 includes a MDDI deep standby mode setting so it can enter a off state and reduce power consumption during Hibernation mode.

The MDDI enters Hibernation mode when a Shutdown Packet is sent. The standby power needs of the Client MDDI can be reduced, even while the MDDI Link is maintained in Hibernation mode.

When entering MDDI deep standby mode, the RM68120 stops operation rather than maintaining Hibernation mode. Input low pulse 3 msec from RESX pin to cancel deep standby mode, after which a Host-Initiated Wake-up should cancel the Hibernation mode.

When in deep standby mode, instruction settings and RAM data are not stored, so they must be reset after Hibernation mode is cancelled.

Follow the sequence indicated in the VESA MDDI specifications when initiating or canceling the Hibernation mode.

State Transitions in MDDI Deep Standby Mode:

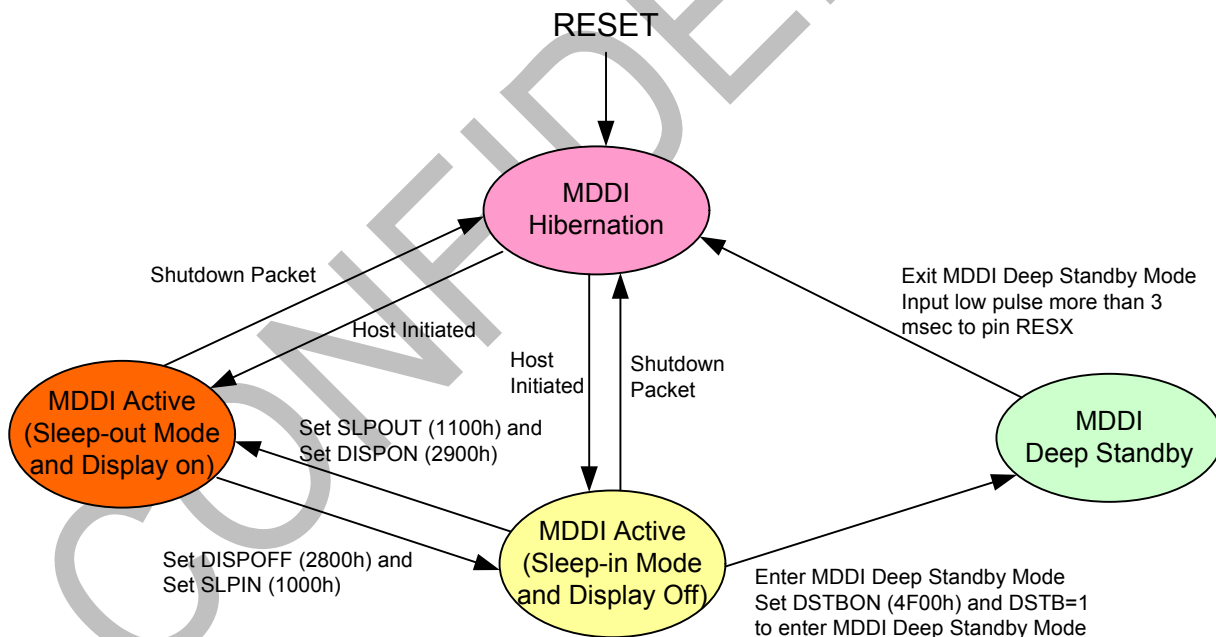

Note: When the RM68120 is in the MDDI Hibernation mode or MDDI deep standby mode, both links are in the link hibernation states.

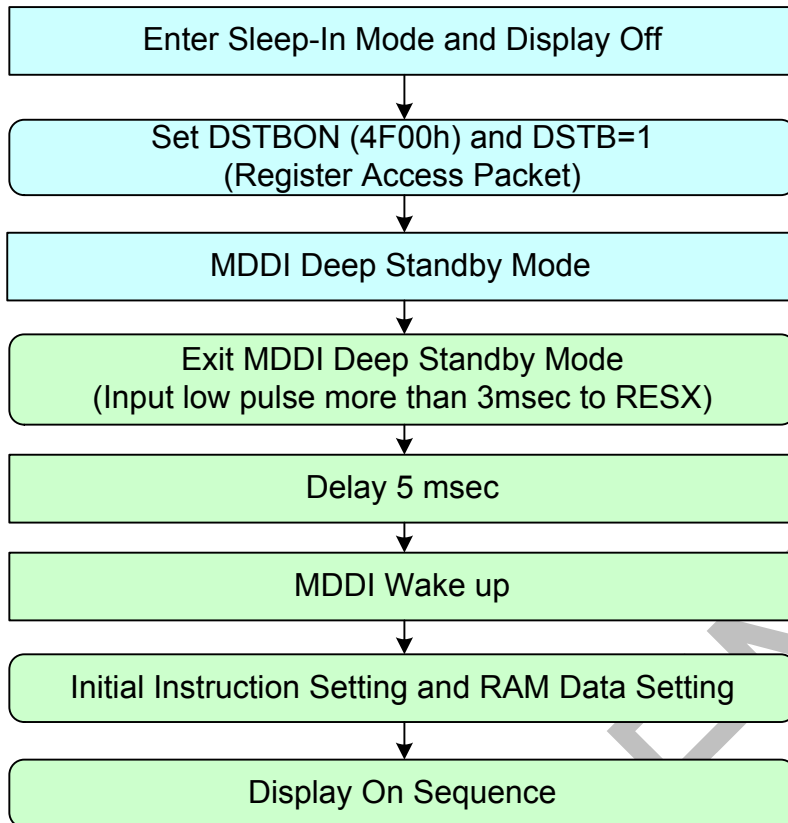
MDDI Deep Standby Mode Sequence

Note: When in MDDI Deep Standby mode, instruction settings and RAM data are not stored, so they must be reset after Hibernation mode is cancelled.

7.8 Display Data RAM

7.8.1 Configuration

The display data RAM stores display dots and consists of 9,953,280bits (480 x 24 x 864 bits). There is no restriction on access to the RAM even when the display data on the same address is loaded to DAC. There will be no abnormal visible effect on the display when there is a simultaneous Panel Read and Interface Read or Write to the same location of the frame memory.

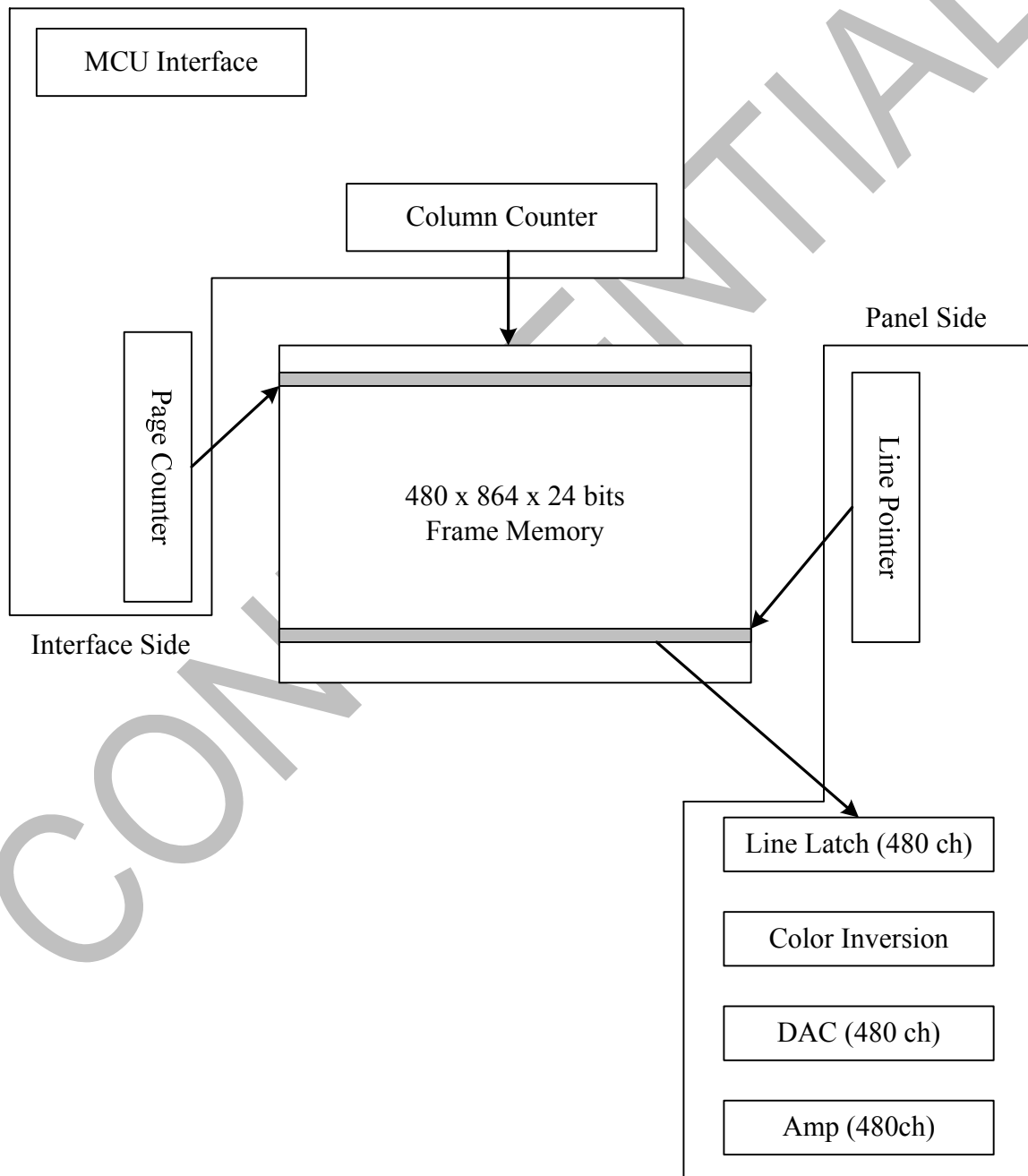

7.8.2 Memory to Display Address Mapping

In this mode, content of the frame memory within an area where column pointer is 0000h to 01DFh and page pointer 0000h to 035Fh is displayed. To display a dot on leftmost top corner, store the dot data at (column pointer, page pointer) = (0, 0).

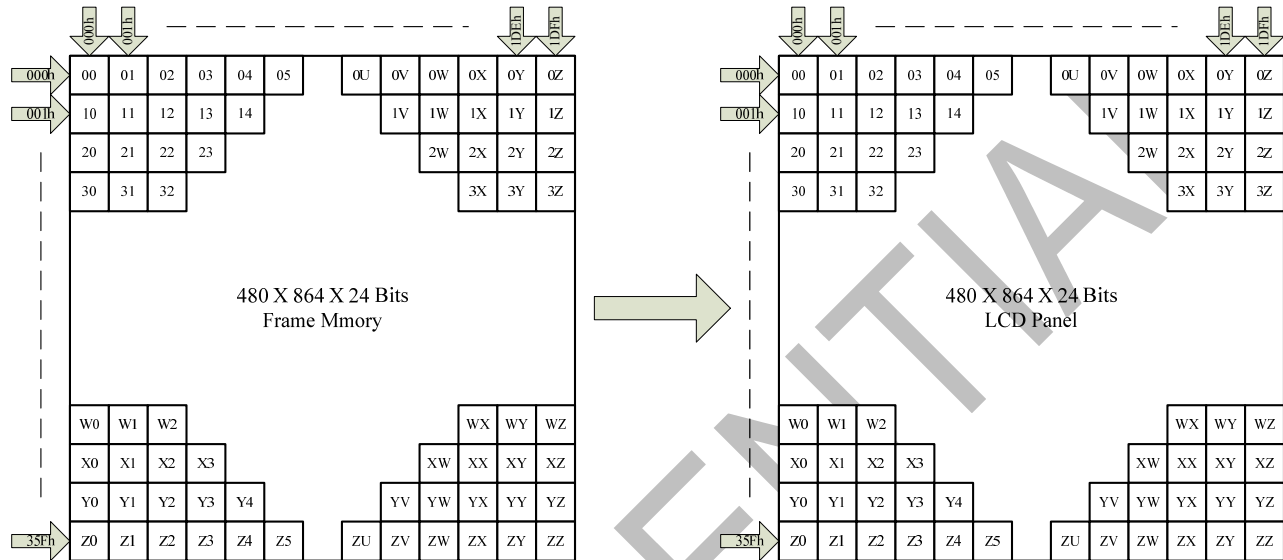

7.9 Tearing Effect Output

The tearing effect output line supplies to the MCU a panel synchronization signal. This signal can be enabled or disabled by the `set_tear_off` (34h) and `set_tear_on` (35h) commands. The mode of the tearing effect signal is defined by the parameter of the `set_tear_on` (35h) and `set_tear_scanline`(44h) commands. The signal can be used by the MCU to synchronize Frame Memory Writing when displaying video images.

7.9.1 Tearing Effect Line Mode

Mode 1, the tearing effect output signal consist of V-sync information only:

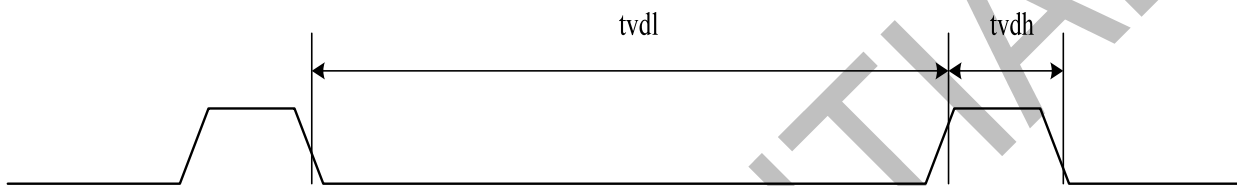

tvdh = The LCD display is not updated from the frame memory.

tvdl = The LCD display is updated from the frame memory.

Mode 2, the tearing effect output signal consist of V-sync and H-sync information:



thdh = The LCD display is not updated from the frame memory.

thdl = The LCD display is updated from the frame memory.

Mode 3, this mode turn on the tearing effect output signal when vertical scanning reaches line N.

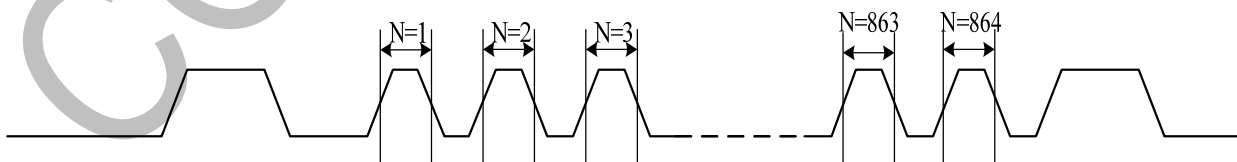

N = The N-th scanning line which set by register N[15:0] of command `STESL`(44h).

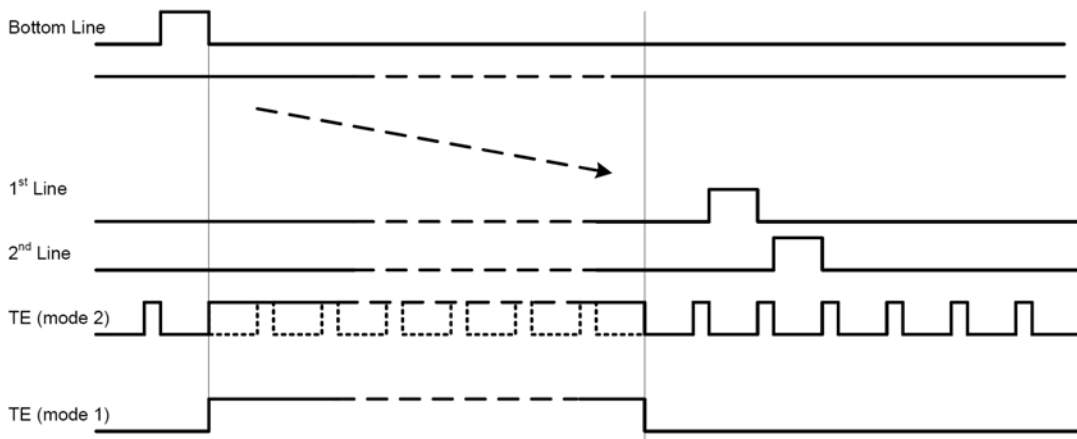

Note. During Sleep In mode, the tearing effect output signal is active low.

CONFIDENTIAL

7.9.2 Tearing Effect Line Timing

The tearing effect signal is described as below:

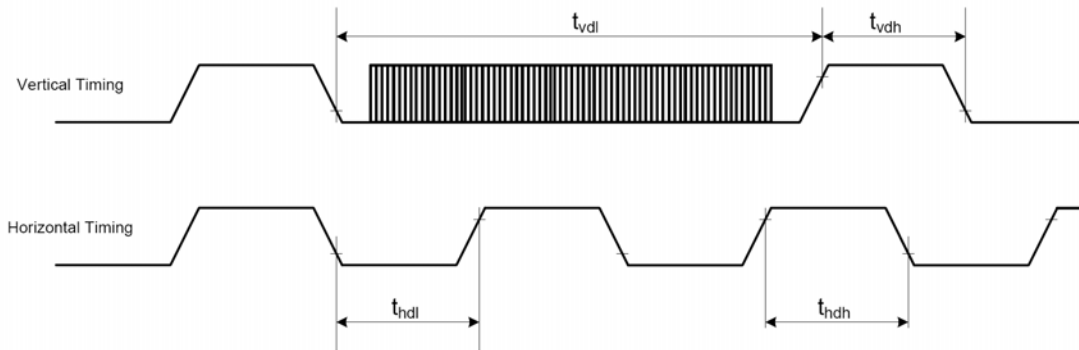

AC characteristics of Tearing Effect Signal (Frame Rate = 60.5Hz)

Symbol	Parameter	Min.	Max.	Unit	Description
tvdl	Vertical timing low duration	TBD		ms	
tvdh	Vertical timing high duration	TBD		us	
thdl	Horizontal timing low duration	TBD		us	
thdh	Horizontal timing high duration	TBD		us	

Notes:

1. The timings apply when MADCTL B4=0 and B4=1
2. The signal's rise and fall times (t_f , t_r) are stipulated to be equal to or less than 15ns.

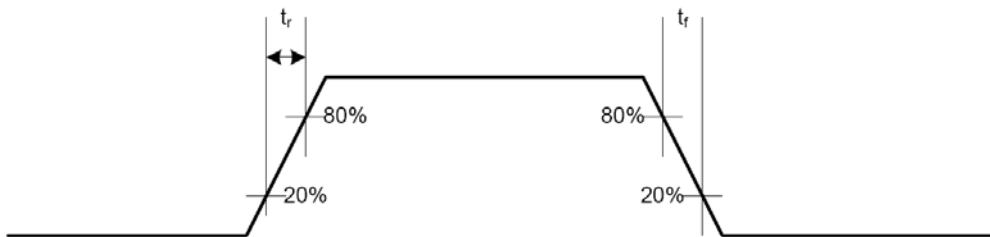

The Tearing Effect Output Line is fed back to the MCU and should be used as shown below to avoid tearing effect:

The Tearing Effect output line supplies to the MCU a panel synchronization signal. This signal can be enabled or disabled by the `set_tear_off(34h)`, `set_tear_on(35h)` commands. The mode of the Tearing Effect Signal is defined by the Parameter of the Tearing Effect Line On command. The signal can be used by the MCU to synchronize Frame Memory Writing when displaying video images.

TEON (35h)	TELOM (35h, 1 st bit)	TE signal Output
0	*	GND
1	0	TE (Mode 1)
1	1	TE (Mode 2)

7.10 Panel Type

7.10.1 Normal Type

Bottom Side

normal (CTB=0, CRL=0, CRGB=0)

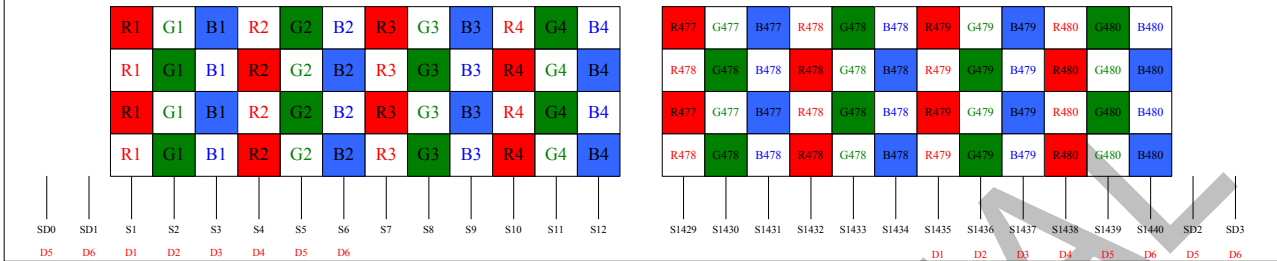

Upper Side

normal (CTB=0, CRL=1, CRGB=1)

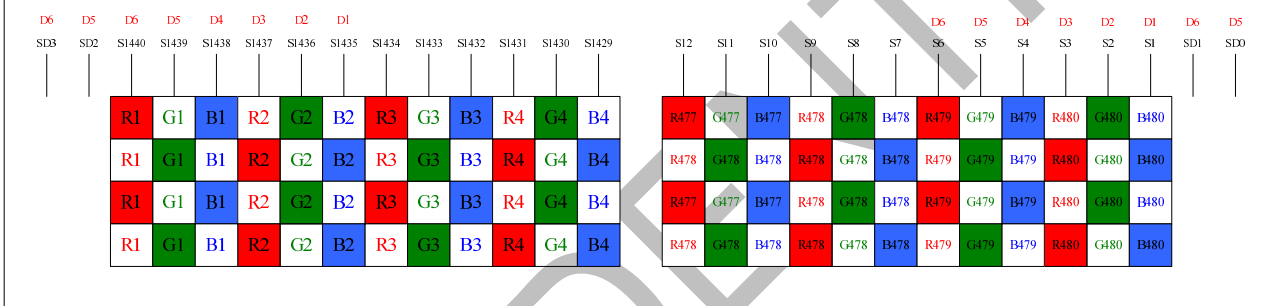

7.10.2 Zigzag Type 1

Bottom Side

Type 1 : ZZ_RL=1, ZZ_EO=0(CTB=0, CRL=0, CRGB=0)

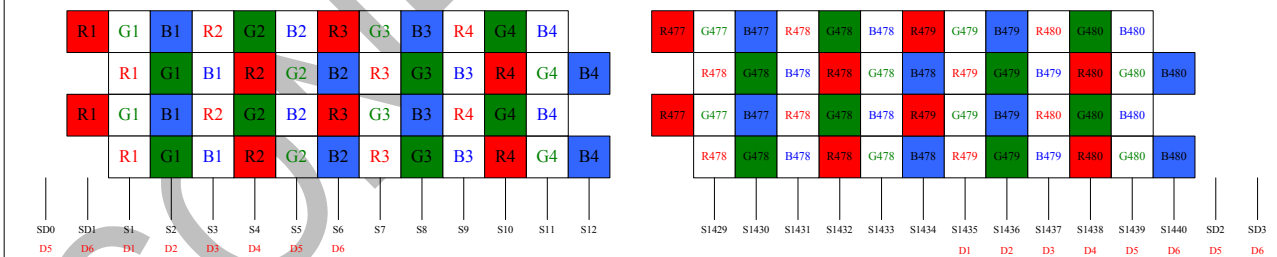

Upper Side

Type 1 : ZZ_RL=0, ZZ_EO=0(CTB=0, CRL=1, CRGB=1)

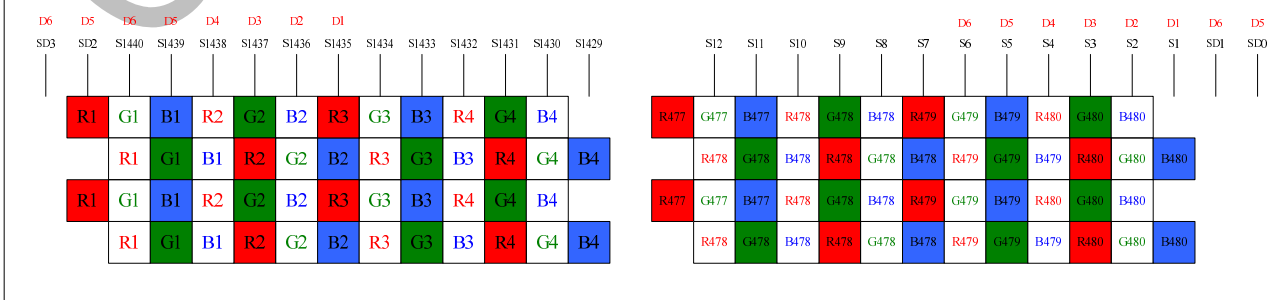

7.10.3 Zigzag Type 2

Bottom Side

Type 2 : ZZ_RL=1, ZZ_EO=1(CTB=0, CRL=0, CRGB=0)

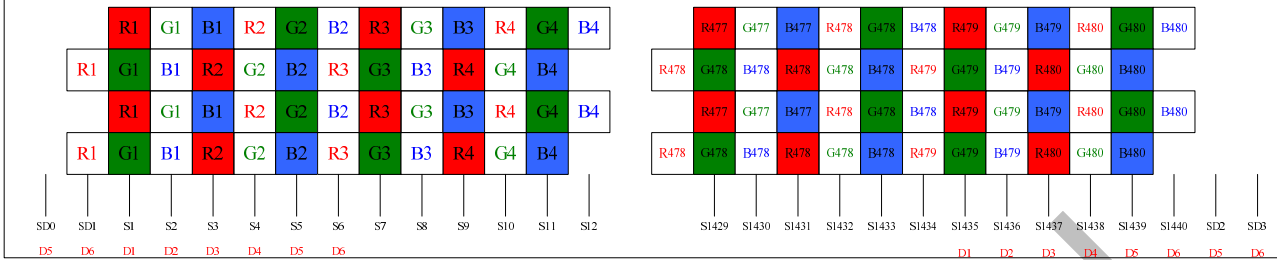

Upper Side

Type 2 : ZZ_RL=0, ZZ_EO=1(CTB=0, CRL=1, CRGB=1)

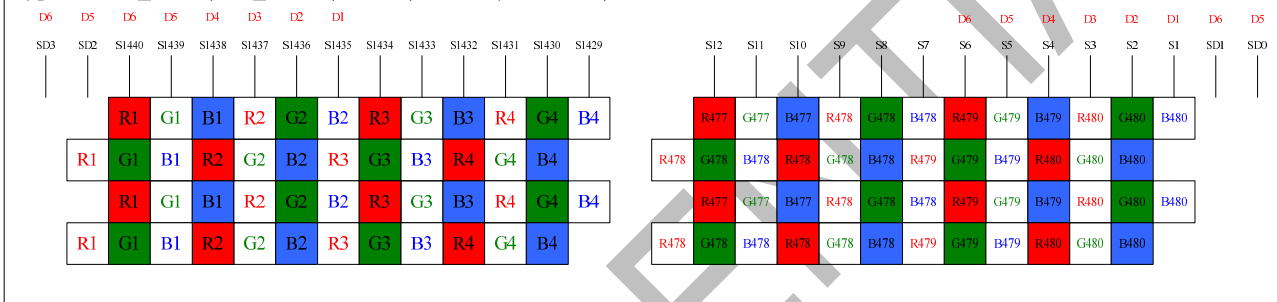

7.10.4 Zigzag Type 3

Bottom Side

Type 3 : ZZ_RL=0, ZZ_EO=0(CTB=0, CRL=0, CRGB=0)

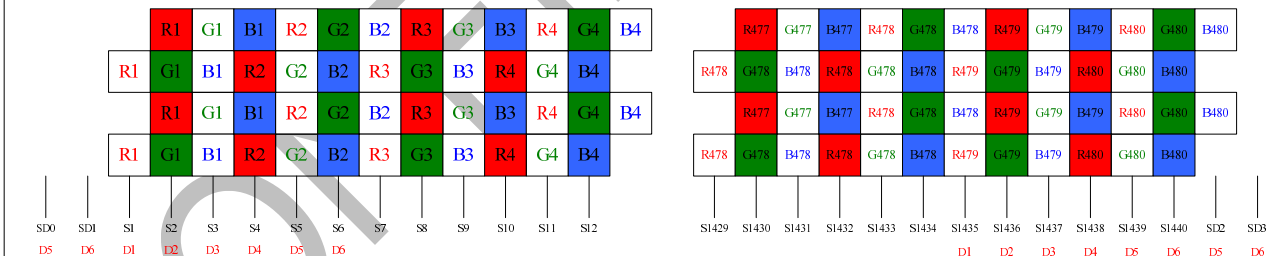

Upper Side

Type 3 : ZZ_RL=1, ZZ_EO=0(CTB=0, CRL=1, CRGB=1)

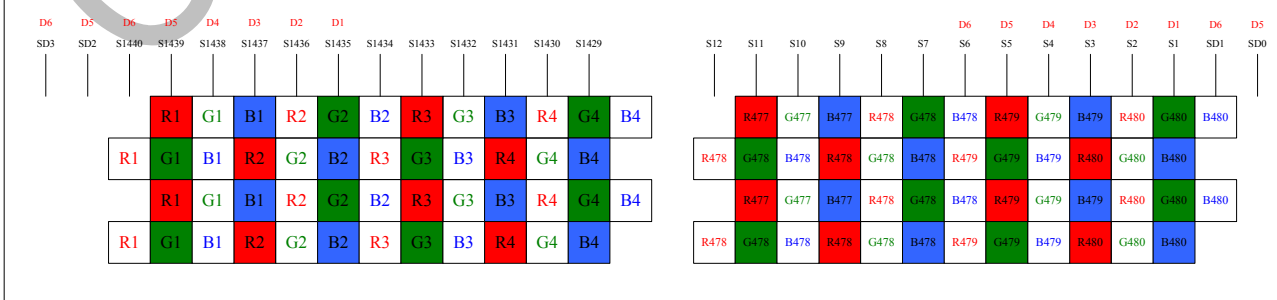

7.10.5 ZigZag Type 4

Bottom Side

Type 4 : ZZ_RL=0, ZZ_EO=1(CTB=0, CRL=0, CRGB=0)

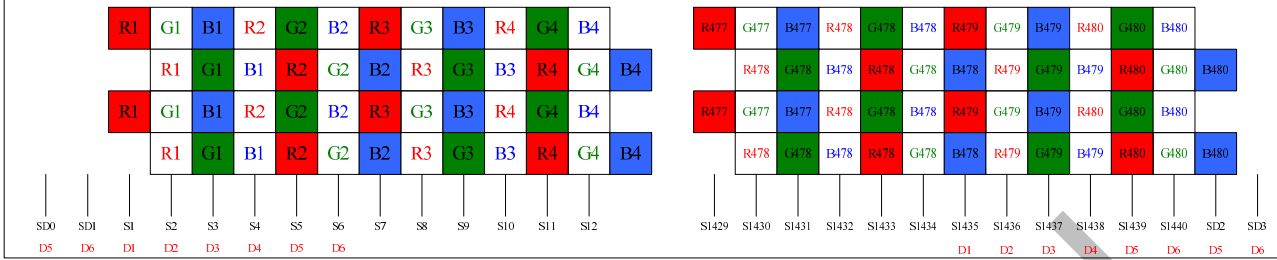

Upper Side

Type 4 : ZZ_RL=1, ZZ_EO=1(CTB=0, CRL=1, CRGB=1)

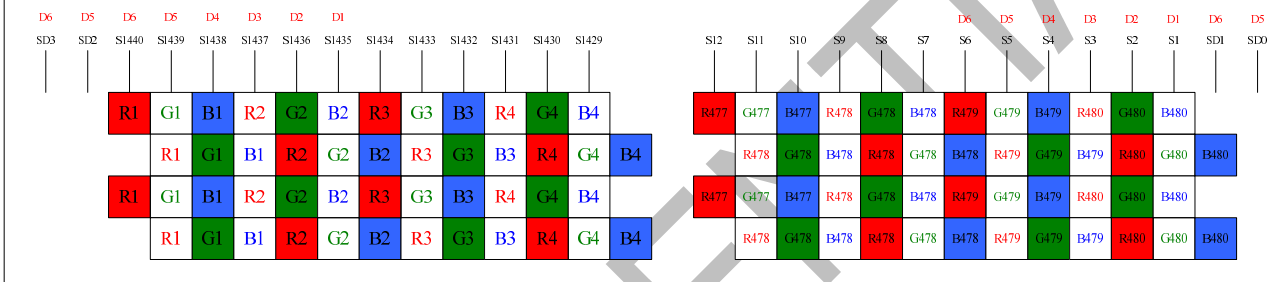

7.11 OTP Program Sequence

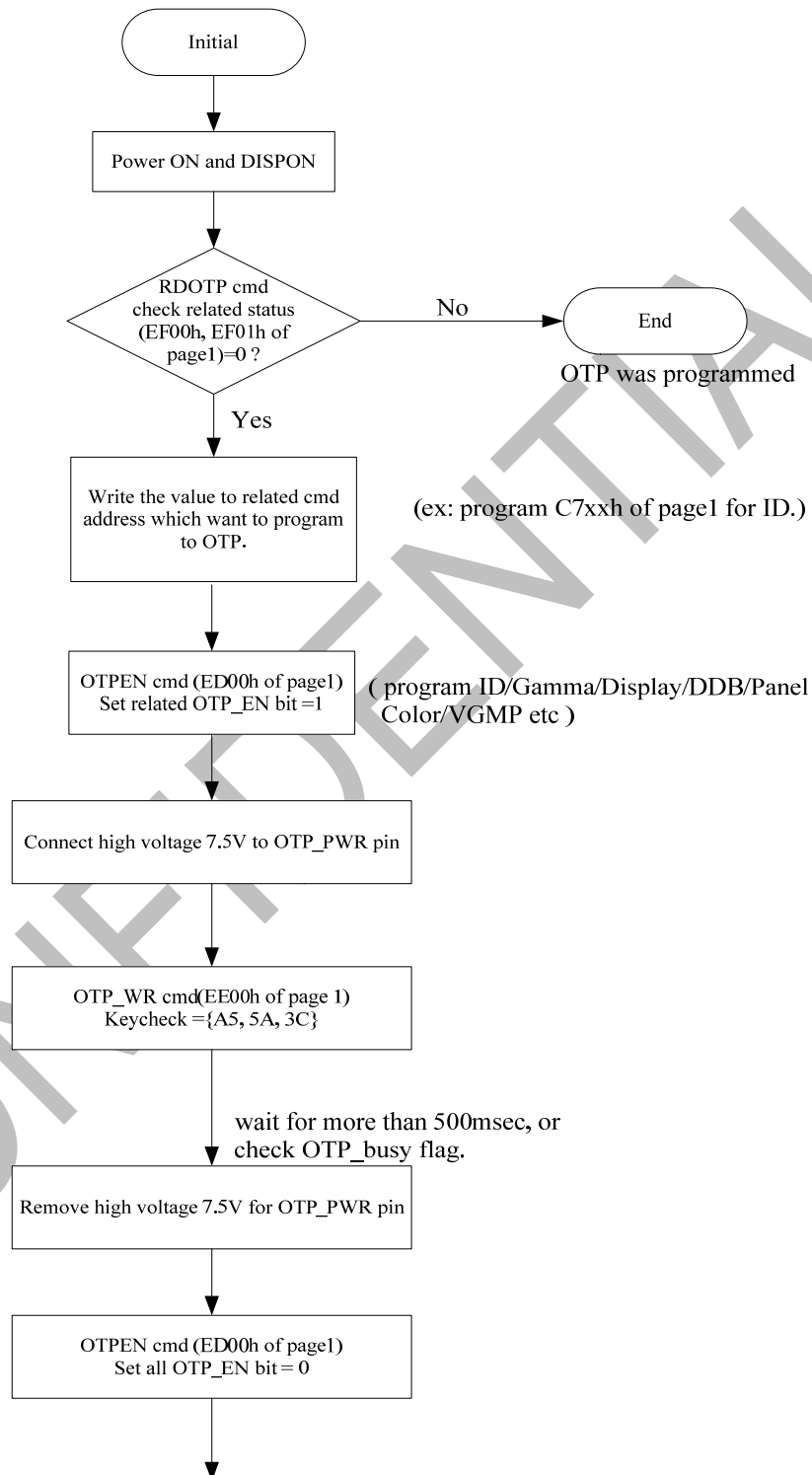

OTP Programming Flow

7.12 Independent Gamma Correction Function

The RM68120 supports independent gamma adjustment function for R color, G color and B color to display in 16.7M colors. The function is performed by determining grayscale levels that use gamma adjustment registers. The RM68120 also provides gradient control registers for adjustments of gamma curve.

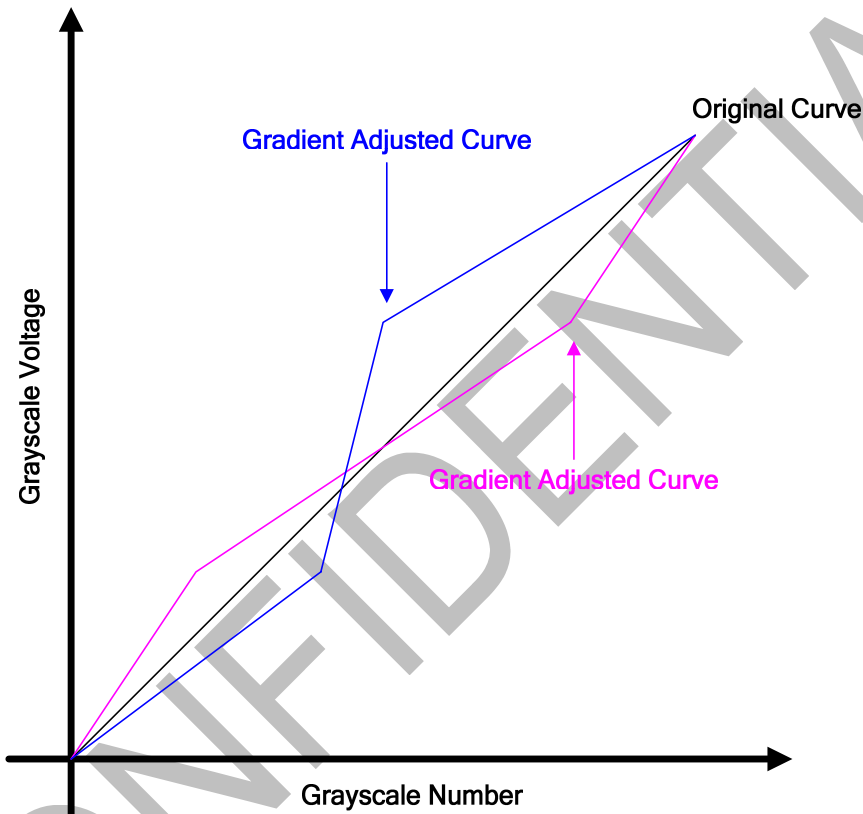

7.13 Dynamic Backlight Control

The function of Dynamic Display Backlight is used to reduce the power consumption of display backlight. It includes Content Adaptive Brightness Control (CABC) and Light-Sensor Automatic Brightness Control (LABC) functions. Both two functions are used to generate a proper PWM signal according to display image and ambient light information. User could apply this PWM signal to control other device(s) (Such as power IC or LED driver IC). When the CABC and LABC functions are enabled and cooperate with external circuits (such as LED driver circuit), the power consumption of backlight will be reduced with keeping acceptable display quality.

The CABC function is used to reduce the power consumption of display backlight. Contents adaptation means that the grayscale level of image contents is raised while lowering brightness of the backlight simultaneously to keep same perceived brightness. The adjustment of grayscale level and brightness reduction is based on the display image contents. Thus the power consumption reduction depends on the contents of the image. The display image and brightness are dynamically processed by CABC block.

In order to achieve a better display quality and reduce power consumption of the backlight at the same time, there are 3 different modes, user interface image mode, still picture mode and moving image mode, for user selections.

The LABC function combines several mechanisms to provide a smooth control of sensed light information. Flicker Removal is used to eliminate external light source flicker (e.g. 50 and 60 Hz). Hysteresis is used for preventing the transient variation of luminance. When the LABC function is enabled, the information of the ambient light is sent to the brightness control block. The user can read ambient light information or this information can be used for automatic brightness control by the brightness control block. It is also possible to control the brightness manually.

With combination of the CABC and the LABC processed results, the display output brightness is adjusted.

Display Backlight Brightness = LABC Brightness Ratio (or Manual Setting Ratio) x CABC Brightness Ratio

The function of CABC affects both display brightness ratio and grayscale level. The function of LABC affects display brightness ratio only.

Display Brightness Output of combinations of CABC and LABC function

	LABC(Manual) Brightness Ratio	CABC(Manual) Brightness Ratio	Calculation Ratio	Brightness Output of LEDPWM	Image Status
Case 1	70%	60%	42%	42%	CABC modified
Case 2	50%	100%	50%	50%	CABC modified
Case 3	40%	30%	12%	12%	CABC modified

7.13.1 PWM Control Architecture

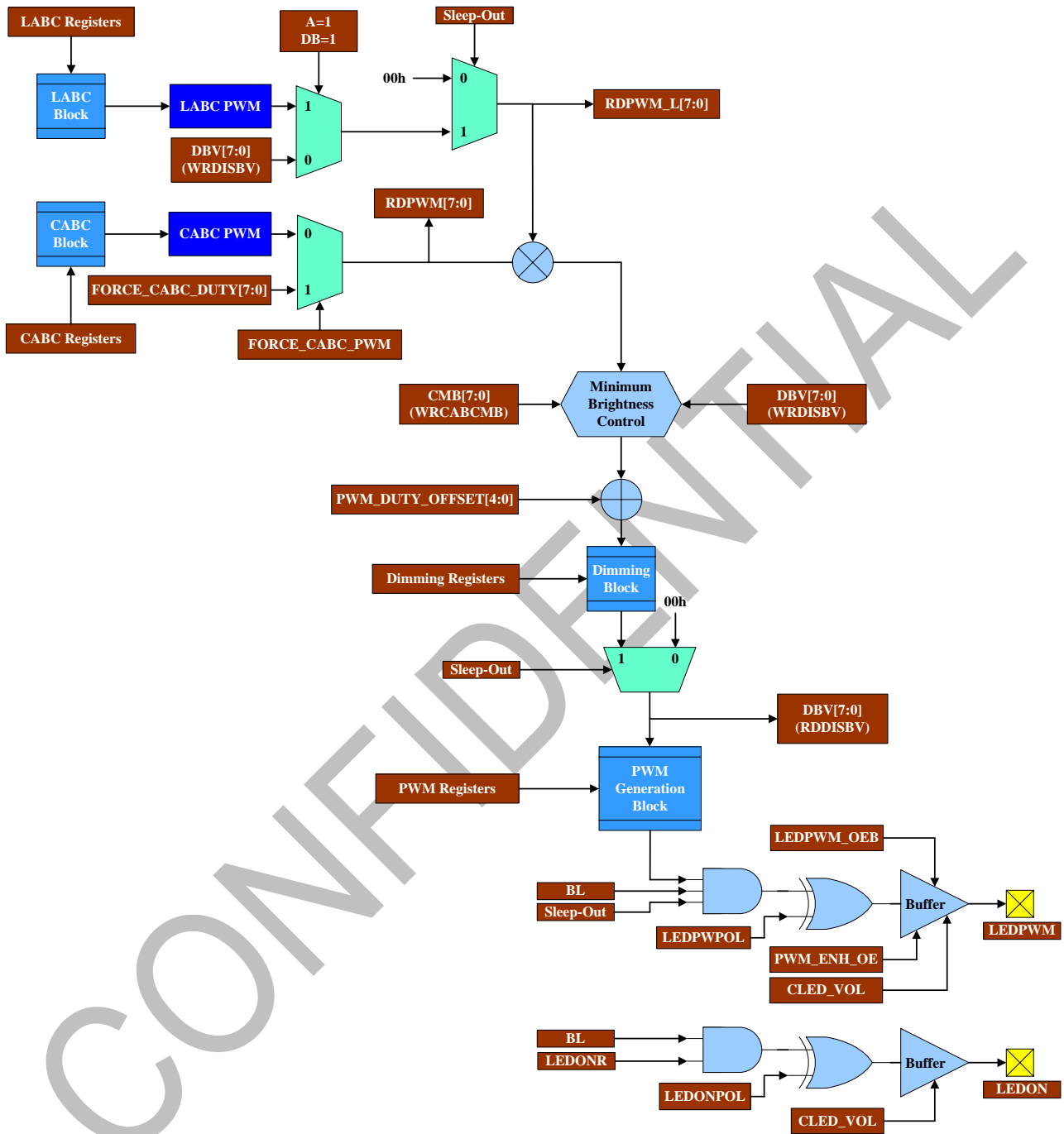

Internal Display Backlight Control

The register bit “BL” is used to turn on or turn off backlight control lines, “LEDPWM” pin and “LEDON” pin. Normally, if user want to disable the display backlight completely and immediately, user can set “BL = 0”. Relations between “BL” and control lines are list below.

BL	LEDPWPOL	Status of LEDPWM Pin	BL	LEDONPOL	Status of LEDON Pin
0	0	0	0	0	0
	1	1		1	1
1	0	Original polarity of PWM signal	1	0	LEDONR
	1	Inversed polarity of PWM signal		1	Inverted LEDONR

The register bit “BCTRL” is used to turn on or turn off backlight control block. Display brightness which is controlled by LEDPWM will be turn off when user set “BCTRL = 0”.

BCTRL	Value of DBV[7:0] (RDISBV)	Display Backlight Status
0	00h	off
1	Determined by CABC and LABC	on

The register bit “PWM_ENH_OE” is used to adjust the driving ability of “LEDPWM” pin (“PWM_ENH_OE” can not affect the driving ability of “LEDON” pin).

The register bit “CLED_VOL” is used to choose different output logical voltage level for LEDON, LEDPWM pins. This bit is valid when:

(1) DSTB_DEL=low, or (2) DSTB_SEL=high, VDDI=1.65~3.3V and VSEL=high

(The output level is VSSI to DIOPWR for other VDDI and VSEL conditions in DSTB_SEL=high). See below for the selection output level

CLED_VOL	LEDON/LEDPWM Output Level	PWM_ENH_OE	Driving Ability of LEDPWM Pin
0	VSSI to VDDI	0	1X driving ability of LEDPWM
1	VSSI to VDDA	1	2X driving ability of LEDPWM

The register bit “A” is used to enable / disable LABC functions. Sampling of ambient light information started after setting the register bit “A”. User has to write the ambient light information into the register “LS[15:0]” via system interface.

The register bit “DB” is used to select manual or automatic brightness control. When “DB=0”, the display backlight brightness can be affected by setting register “DBV[7:0]” (WRDISBV) manually. When “DB =1” display backlight is affected by automatic brightness control. Relations between register bits “DB”, “A”, DBV[7:0] (WRDISBV), RDPWM[7:0], and RDPWM_L[7:0] are listed in below tables.

Driver IC State	A	DB	Display Backlight Control
Sleep-In	x	x	Disable
Sleep-Out	0	0	Control by manual setting DBV[7:0] (WRDISBV)
Sleep-Out	0	1	Control by manual setting DBV[7:0] (WRDISBV)
Sleep-Out	1	0	Control by manual setting DBV[7:0] (WRDISBV)
Sleep-Out	1	1	Control by LABC function

“FORCE_CABC_PWM=0”, “CMB[7:0] = 00h” (WRCABCMB),
“PWM_DUTY_OFFSET[4:0]=00h”, “BL=1”, “BCTRL=1”, Sleep-Out Mode

CABC Status	A	DB	RDPWM_L[7:0]	RDPWM[7:0]	Display Backlight Brightness
Off Mode	0	0	Determined by DBV[7:0] (WRDISBV)	FFh	Determined by DBV[7:0] (WRDISBV)
	0	1			
	1	0			
	1	1	Determined by LABC Function	FFh	Determined by LABC Function
UI-Mode / Still-Mode / Moving-Mode	0	0	Determined by DBV[7:0] (WRDISBV)	Determined by CABC Function	Determined by DBV[7:0] (WRDISBV) x CABC Function
	0	1			
	1	0			
	1	1	Determined by LABC Function	Determined by CABC Function	Determined by LABC Function x CABC Function

The writing register DBV[7:0] (WRDISBV) is used to adjust the backlight brightness value manually when LABC function is disabled (register bit “A=0” and “DB=0”). Note that reading register DBV[7:0] (RDDISBV) is used to indicate the output PWM signal duty variation. That means DBV[7:0] (RDDISBV) is also affected by CABC function when CABC function is enable.

The register setting CMB[7:0] (WRCABCCMB) is used to limit the minimum PWM duty in order to prevent the backlight brightness from being too dark.

The register FORCE_CABC_DUTY[7:0] is used to perform a fixed PWM duty of CABC output when the register bit “FORCE_CABC_PWM=1”.

The register bit “DD” is used to enable or disable the dimming function for LABC / Manual Brightness Control. Smooth transition of PWM duty is performed when “DD=1”. Dimming function is applied only when driver IC is in sleep-out status. CABC function and LABC function are available only when driver IC is in sleep-out status. Availability of functions is listed in below table.

Driver IC Status	CABC Function	LABC Function	Dimming Function	Display Backlight Status
Sleep-In	Not Available	Not Available	Not Available	Turn-Off
Sleep-Out	Available	Available	Available	Controllable

7.13.2 Dimming Function for LABC and Manual Brightness Control

A dimming function (how fast to change the brightness from old to new level and what are brightness levels during the change) is used when changing from one brightness level to another. The dimming function curves for LABC and Manual Brightness Control can be configured the same or not the same in increment and decrement directions. The basic idea is described below.

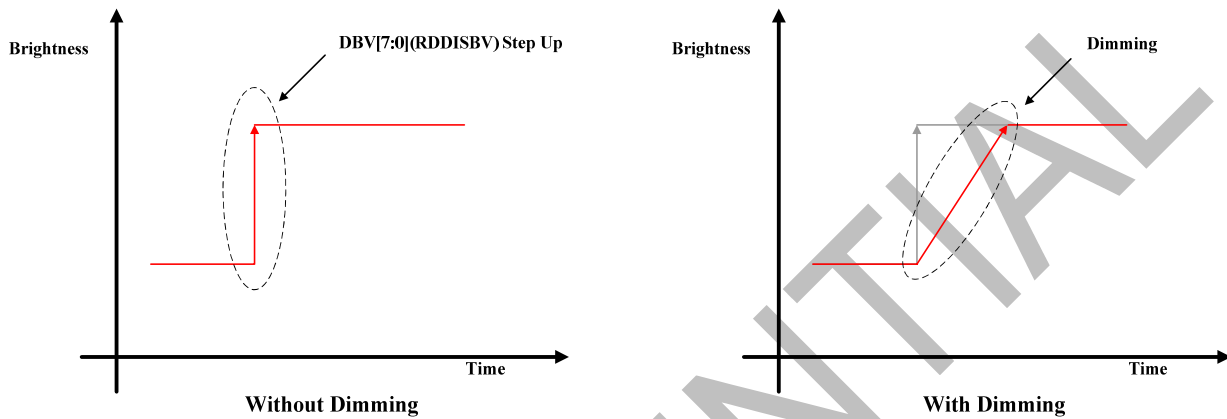

Basic Concept of Dimming Function

The RM68120 provides two types of PWM duty dimming mechanism, “Fixed-Time Dimming” and “Fixed-Slope Dimming”, for LABC and manual brightness control. The setting of dimming types for rising dimming and falling dimming is independent. The register bit “SEL_IN” is for rising dimming (increment dimming), and the register bit “SEL_DE” is for falling dimming (decrement dimming).

SEL_IN	SEL_DE	Rising Dimming Type	Falling Dimming Type
0	0	Fixed-Time Dimming	Fixed-Time Dimming
0	1	Fixed-Time Dimming	Fixed-Slope Dimming
1	0	Fixed-Slope Dimming	Fixed-Time Dimming
1	1	Fixed-Slope Dimming	Fixed-Slope Dimming

Fixed-Time Dimming Type

The total dimming steps and can be set by registers “DMSTP_L[2:0]”, “DM_IN[3:0]”, and “DM_DE[3:0]”, respectively. These three registers can determine the total dimming time.

The unit of registers “DM_IN[3:0]” and “DM_DE[3:0]” is “frame(s) per step”. The unit of register DMSTP_L[2:0] is “step(s)”

For Example:

Register Name	Value	Description
SEL_IN	0	Fixed-Time dimming for rising dimming
SEL_DE	0	Fixed-Time dimming for falling dimming
DM_IN[3:0]	7h	8 frames time for each step
DN_DE[3:0]	5h	6 frames time for each step
DMSTP_L[2:0]	1h	dimming steps is 4 steps

Total dimming time of “rising dimming” is 32-frames time length (8 frames x 4).
Total dimming time of “falling dimming” is 24-frames time length (6 frames x 4).

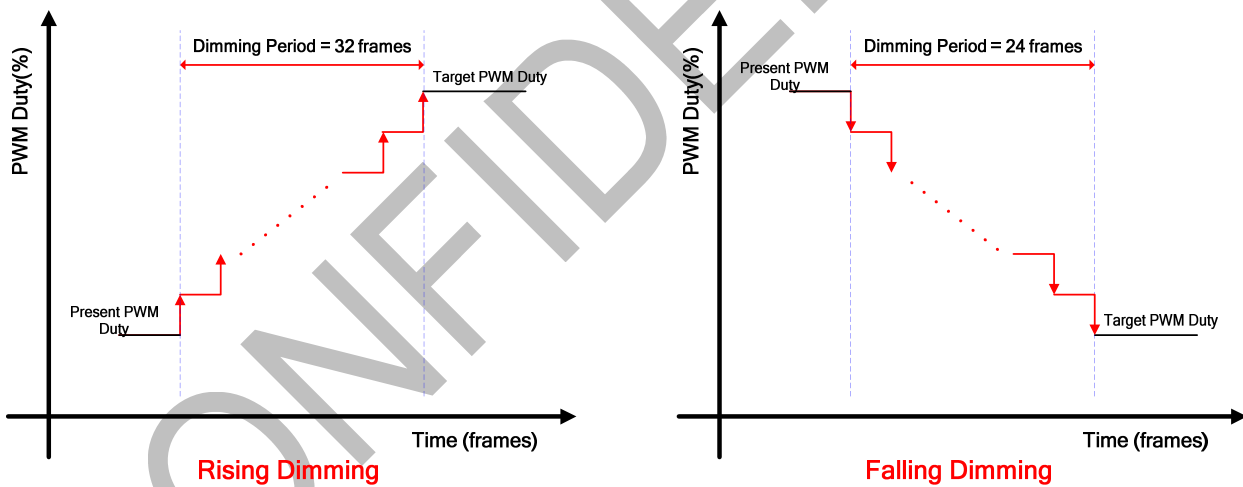

Fixed-Slope Dimming Type

The increasing / decreasing PWM duty during a time period can be set by register “STEP_IN[3:0]”, “STEP_DE[3:0]”, “DM_IN[3:0]”, and “DM_DE[3:0]”, respectively. These three registers can determine some characteristics of dimming curves.

The unit of registers STEP_IN[3:0] and STEP_DE [3:0] is “duty ratio” (FFh is 100%, and 00h is 0%). The unit of register DM_IN[3:0] and DM_DE[3:0] is “frame(s) per step”.

For Example:

Register Name	Value	Description
SEL_IN	1	Fixed-Slope dimming for rising dimming
SEL_DE	1	Fixed-Slope dimming for falling dimming
STEP_IN[3:0]	8h	PWM increment is 8 for each step
STEP_DN[3:0]	5h	PWM decrement is 5 for each step
DM_IN[3:0]	3h	4 frames time for each step
DM_DE[3:0]	5h	6 frames time for each step

When present PWM duty is “0x64” (100 in decimal), target PWM duty is 0x14 (20 in decimal), so the total dimming steps will be:

$$\begin{aligned} \text{Total dimming steps} &= (\text{Present PWM Duty} - \text{Target PWM duty}) / (\text{PWM decrement}) \\ &= (100 - 20) / 5 = 16 \text{ steps} \end{aligned}$$

So total dimming time for falling dimming is 80 frames (16 Steps x 5)

When new target PWM duty is “0x64”, the total dimming steps will be:

$$\begin{aligned} \text{Total dimming steps} &= (\text{Target PWM Duty} - \text{Present PWM duty}) / (\text{PWM increment}) \\ &= (100 - 20) / 8 = 10 \text{ steps} \end{aligned}$$

So total dimming time for rising dimming is 40 frames (10 Steps x 4)

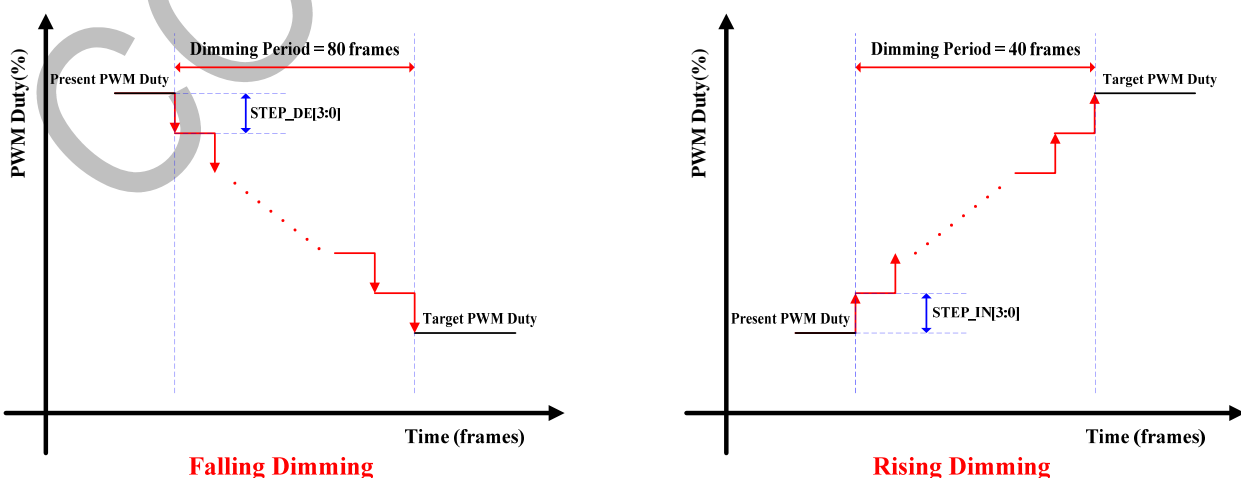

7.13.3 PWM Signal Setting for CABC and LABC

The registers “PWMDIV[7:0]” can change the frequency of PWM signal(LED PWM) and the register “PWM_DUTY_OFFSET[4:0]” can perform a duty compensation of the PWM signal. The “FOSC” is used to provide clock source for the internal PWM circuit. Three PWM operation frequency can be chosen by setting register “PWF[1:0]”, and the real PWM frequency can be quickly estimated by the below formula.

PWF[1:0]	PWM Operation Frequency (F _{osc})
00	7 MHz
01	14 MHz
10	3.5 MHz
11	(not used)

$$PWM \text{ Frequency} = \frac{F_{osc}}{256 \times PWMDIV[7:0]}$$

$$PWM \text{ Duty} = \frac{DBV[7:0](RDDISBV) + 1}{256}$$

For example:

If “PWMDIV[7:0]=0x0F”, “PWF[1:0]=0x0”, “DBV[7:0]=2Fh”(RDDISBV)

$$PWM \text{ Frequency} = \frac{7MHz}{256 \times 15} \approx 1.82KHz$$

“DBV[7:0]=2Fh” means PWM duty ratio is about 18.75%

$$PWM \text{ Duty Time} = 18.75\% \times \frac{1}{1.82KHz} \approx 103.0\mu s$$

$$PWM \text{ non-Duty Time} = 81.25\% \times \frac{1}{1.82KHz} \approx 446.4\mu s$$

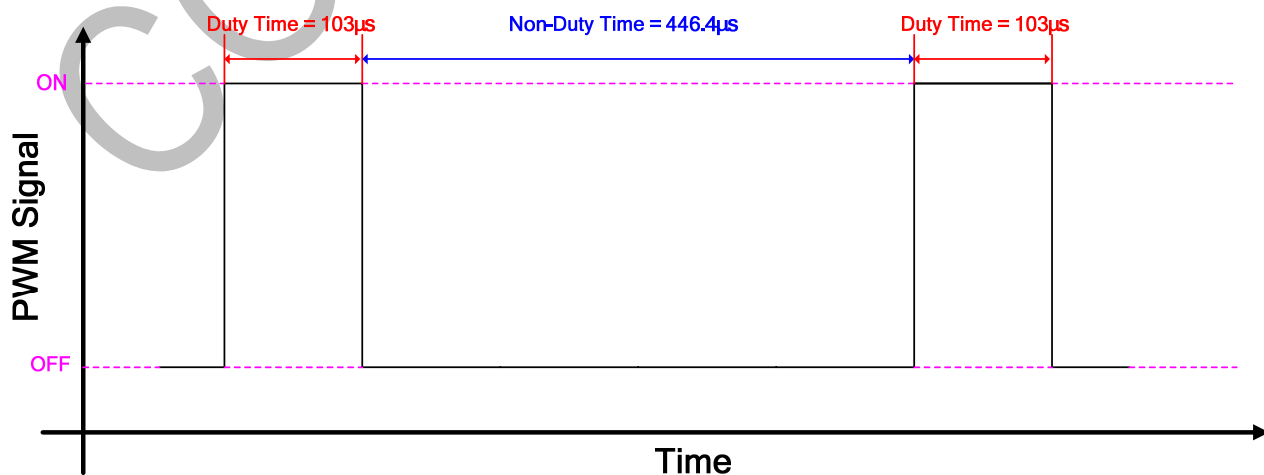

Since the external LED driver needs some stable time to drive the LED backlight, this necessary stable time will reduce the effective PWM duty period. The PWM_DUTY_OFFSET[4:0] is simply used to compensate the loss of PWM duty period. For example, assume original PWM duty of LEDPWM signal is 60%, but the actual backlight brightness driven by LED driver is 57%. User can set "PWM_DUTY_OFFSET[4:0]" to achieve 60% backlight brightness.

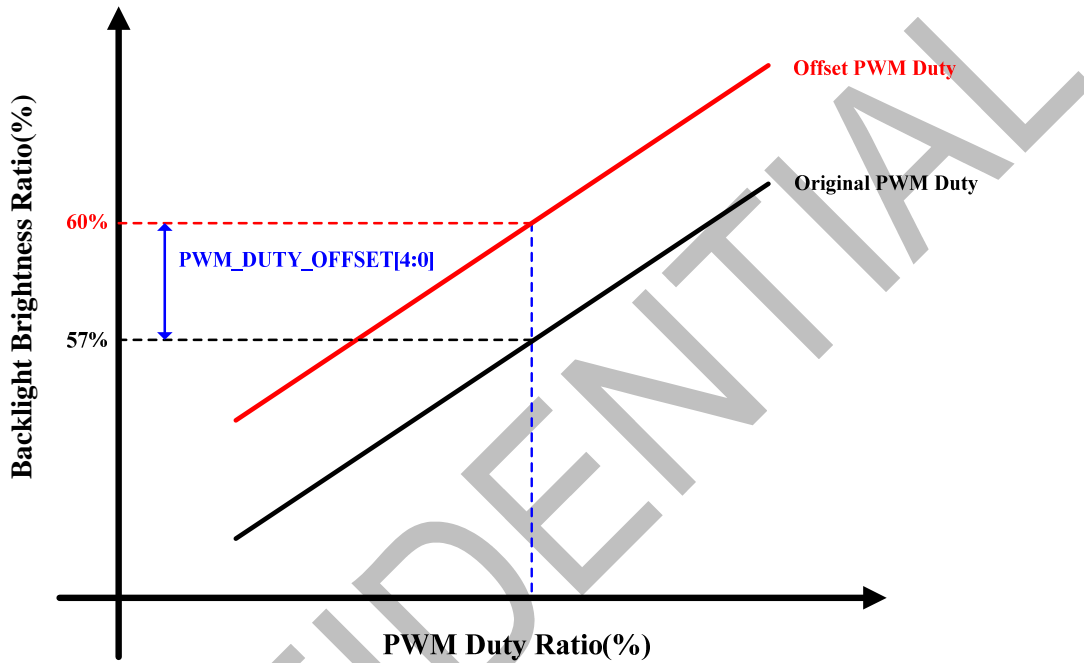

7.13.4 Content Adaptive Brightness Control (CABC)

A Content Adaptive Brightness Control function can be used to reduce the power consumption of the luminance source. Content adaptation means that content grey level scale can be increased while simultaneously lowering brightness of the backlight to achieve same perceived brightness. The adjusted grey level scale and thus the power consumption reduction depend on the content of the image. There four different modes of CABC can be controlled through register "C[1:0]"(WRCABC).

Descriptions of these four modes are listed below:

1. Off mode: Content Adaptive Brightness Control functionality is totally off.
2. UI [User interface] image mode: Optimized for UI image. It is kept image quality as much as possible. Target power consumption reduction ratio: 10% or less. User can achieve prefer brightness for UI-Mode by setting the registers "CABC_UI_PWM0[7:0]" ~ "CABC_UI_PWM3[7:0]".
3. Still picture mode: Optimized for still picture. Some image quality degradation would be acceptable. Target power consumption reduction ratio: more than 30%. The RM68120 will automatically estimate a better gamma setting based on image contents. User can achieve prefer brightness for still picture mode by setting the registers "CABC_PWM0[7:0]" ~ "CABC_PWM9[7:0]".
4. Moving image mode: Optimized for moving image e.g. Video clip. It is focused on the biggest power reduction with image quality degradation. Target power consumption reduction ratio: more than 30%. The RM68120 will automatically estimate a better gamma setting based on image contents. User can achieve prefer brightness for still picture mode by setting the registers "CABC_MOV_PWM0[7:0]" ~ "CABC_MOV_PWM9[7:0]".

7.13.5 Light-Sensor Automatic Brightness Control (LABC)

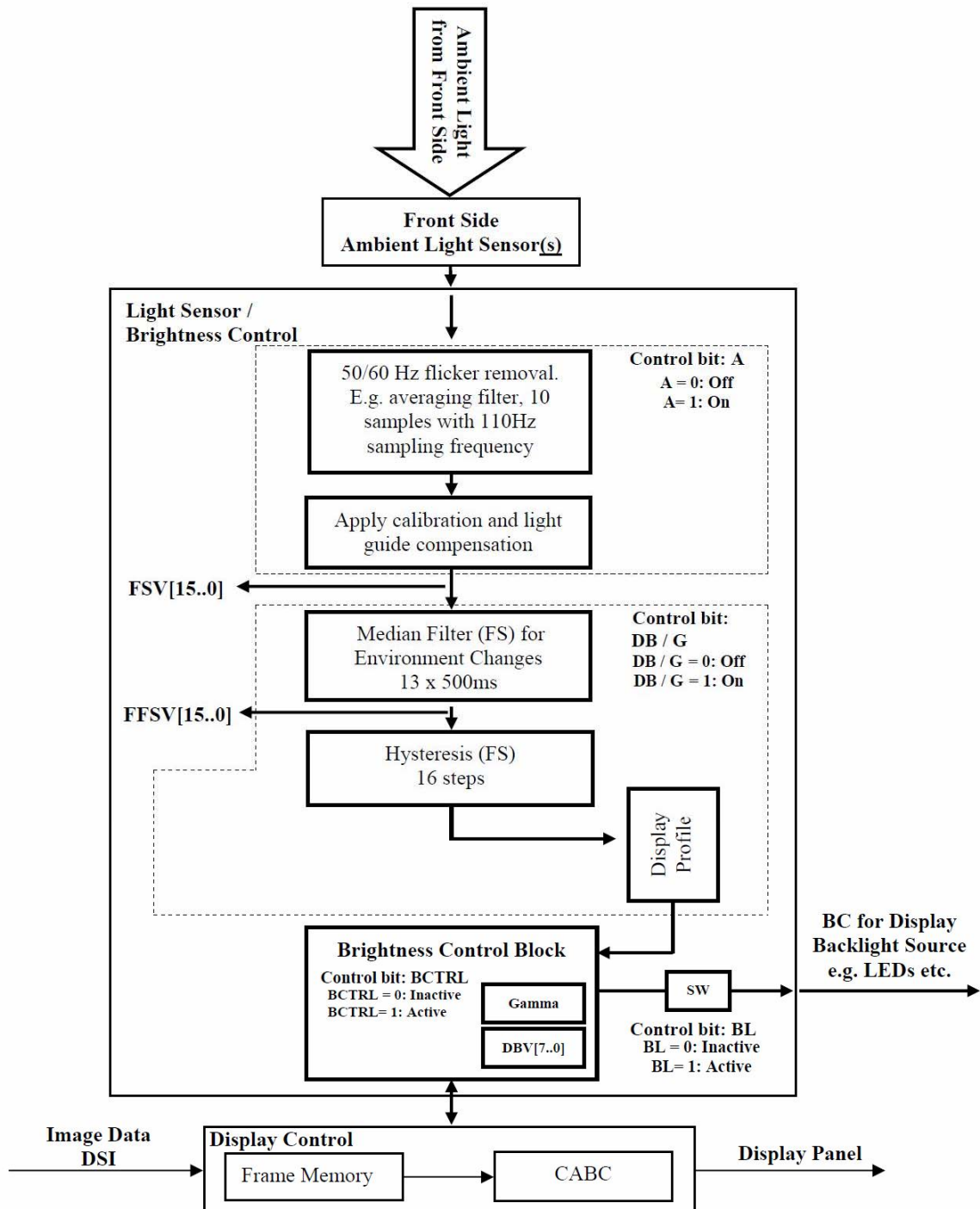

50/60Hz FLICKER REMOVAL

“50/60 Hz flicker removal” block is to sample light sensor information via system interface. Same block is for filtering external light source flicker (e.g. 50 and 60 Hz), which maybe present in ambient light source measurements. This functionality is possible to implement with e.g. an averaging filter, 10 samples with 110Hz sampling frequency. These samples are pipelined so that the oldest value is dropped out when a new value is entered (First In-First Out queue). Sampling of ambient light is started after receiving “Write CTRL Display (5300h)” command with applicable parameters.

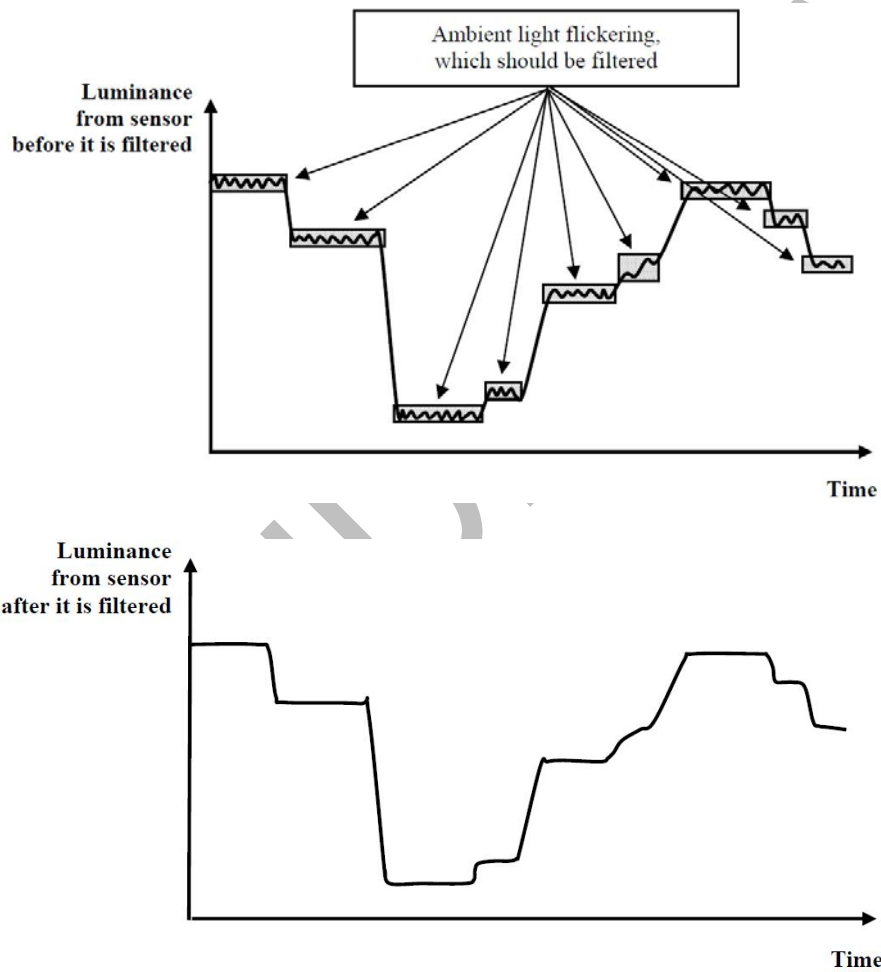

Light Guide Variation Compensation

Filtered luminance value is inputted into “Apply calibration and light guide compensation” block. “Apply calibration and light guide compensation” block is to calibrate and to compensate variation of light guide which is covered on the ambient light sensor. Compensated luminance value can be read by the user (16 bit value, see chapters: “Read MSBs of FSV Value (5A00h)” and Read LSBs of FSV Value (5B00h)”.

In order to perform a calibration for the ambient light sensor system, “Read Light Sensor Compensation Coefficient Value MSBs (66h)” and “Read Light Sensor Compensation Coefficient Value LSBs (67h)” commands can be used to retrieve measured illuminance. User can define a compensation coefficient for the light guide variation. This additional compensation coefficient CC works as a factor multiplying the ambient light value before the value is returned by “Read FS Value MSBs (5A00h)” and “Read FS Value LSBs (5B00h)” commands or used in hysteresis comparison.

$$FS_compensated = CC * FS_filtered$$

FS_compensated: Ambient light information where light guide variation has been taken into account

CC: Compensation coefficient, value range [0.5 – 1.9999]

FS_filtered: Ambient light information after flicker removal

MEDIAN FILTER

Median Filter for Environment Changes block is filtering information received from “Apply calibration and light guide compensation” block.

Median filter receives number of values, which are stored in a queue. The length of the queue is 13 samples. The oldest value stored in the queue is also the first value to drop when a new value is queued (First In-First Out queue). The median filter will sort these values of the queue in ascending order. The median filter selects one of those values based on order of magnitude. Selected value is the 7th value which is the median of the sorted queue.

Selected median filter values are inputted into “Hysteresis” block.

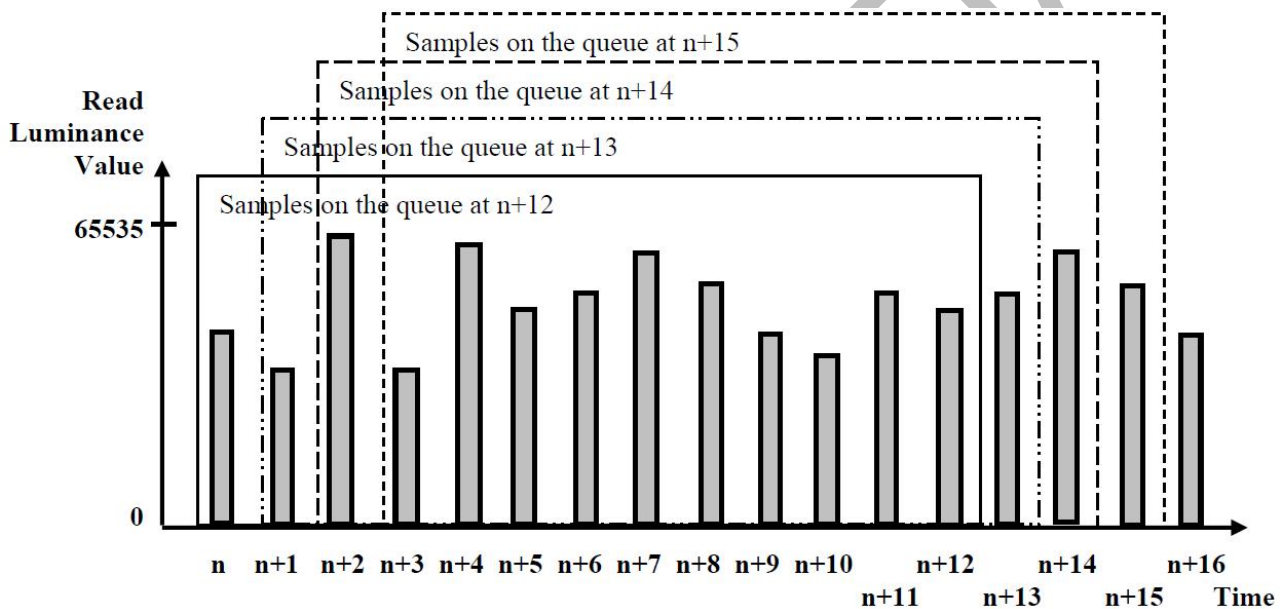

Luminance values of this example are defined on the following table.

Time	Luminance Value (0 – 65535)	Time	Luminance Value (0 – 65535)	Time	Luminance Value (0 – 65535)
n	40960	n+6	51200	n+12	47360
n+1	30720	n+7	58880	n+13	51200
n+2	64000	n+8	53760	n+14	58880
n+3	32768	n+9	40960	n+15	53760
n+4	62720	n+10	38400	n+16	40960
n+5	47360	n+11	51200		

Queues (Read Luminance Values) of this example are defined below.

Time	Values of the Queue												
	1st	2nd	3rd	4th	5th	6th	7th	8th	9th	10th	11th	12th	13th
n+6	40960	30720	64000	32768	62720	47360	51200	58880	53760	40960	38400	51200	47360
n+7	30720	64000	32768	62720	47360	51200	58880	53760	40960	38400	51200	47360	51200
n+8	64000	32768	62720	47360	51200	58880	53760	40960	38400	51200	47360	51200	58880
n+9	32768	62720	47360	51200	58880	53760	40960	38400	51200	47360	51200	58880	53760

The median filter will sort these values in ascending order. Example of sorted values are as below table.

Time	Sorted values in the order of magnitude												
	1st	2nd	3rd	4th	5th	6th	7th	8th	9th	10th	11th	12th	13th
n+6	30720	32768	38400	40960	40960	47360	47360	51200	51200	53760	58880	62720	64000
n+7	30720	32768	38400	40960	47360	47360	51200	51200	51200	53760	58880	62720	64000
n+8	32768	38400	40960	47360	47360	51200	51200	51200	53760	58880	58880	62720	64000
n+9	32768	38400	40960	47360	47360	51200	51200	51200	53760	53760	58880	58880	62720

The median filter selects one of those values based on order of magnitude. Selected value is the 7th value (values highlighted on the table).

HYTERESIS

“Write Gamma setting (58h)” and “Write Profile Values (50h)”.

For each step number ‘n’, the following values are defined:

An 8-bit value (Vn) which sets the display brightness.

A 16-bit value (In) ‘increment step’ value. If the output value of the median filter is greater than the previous one, then the In values represent the transition from the step “n” to step “n + 1”.

A 16-bit value (Dn) ‘decrement step’ value. If the output value of the median filter is smaller than the previous one, then the Dn values represent the transition from the step “n” to step “n + 1”.

A 4-bit (Gn) ‘gamma curve select’ value. This uses a 1-hot encoding to select which gamma curve will be used for each step.

Maximum step number (n) is 16.

The following figure shows a graph of hysteresis input value vs. display backlight brightness output for an arbitrary hysteresis curve. For this graph, step 12 is before the last step in the current profile, and so doesn’t have any increment or decrement step values associated with it. For the last step both increment and decrement values are set to 65535 (FFFFh).

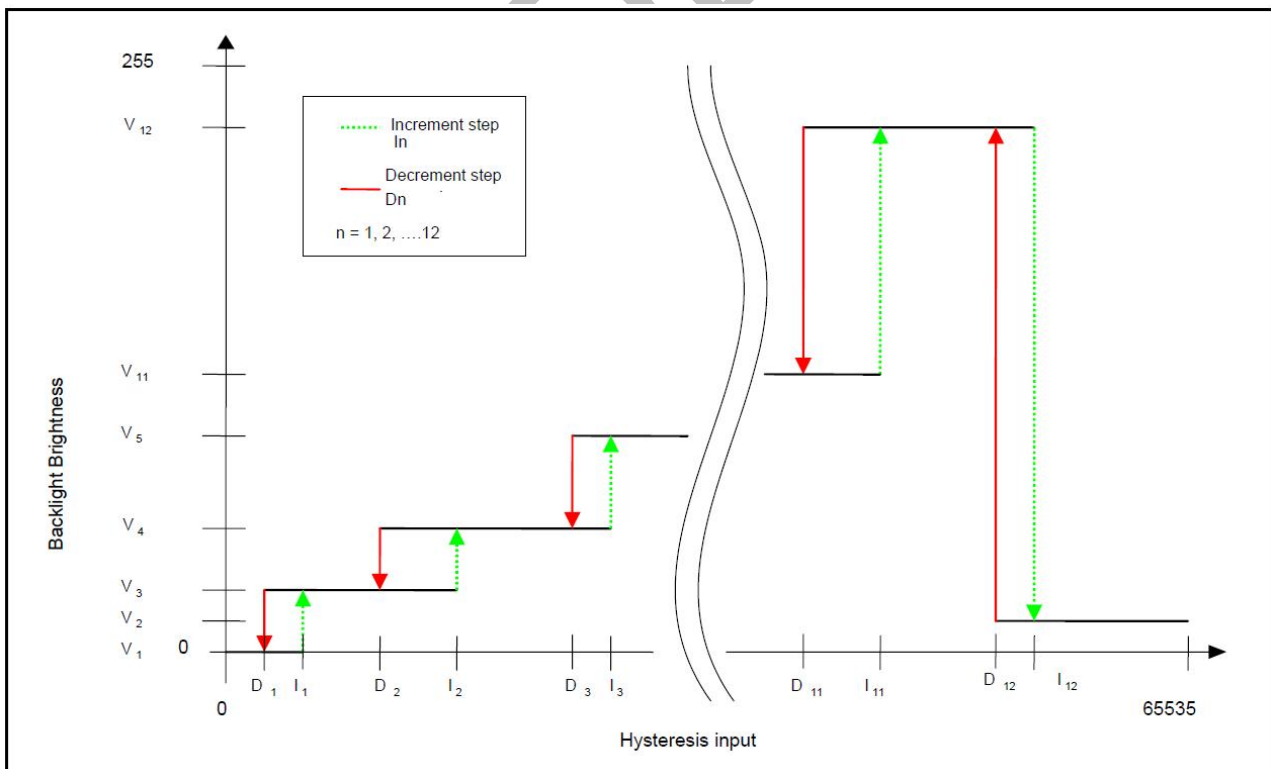

This curve can be split into two separate cases, one for increasing input, and one for decreasing input (see below figure). Once the hysteresis is known to be increasing or decreasing, it can choose correct graph. Then it is relatively simple to go through each of the levels in turn, checking against the increment or decrement values as necessary.

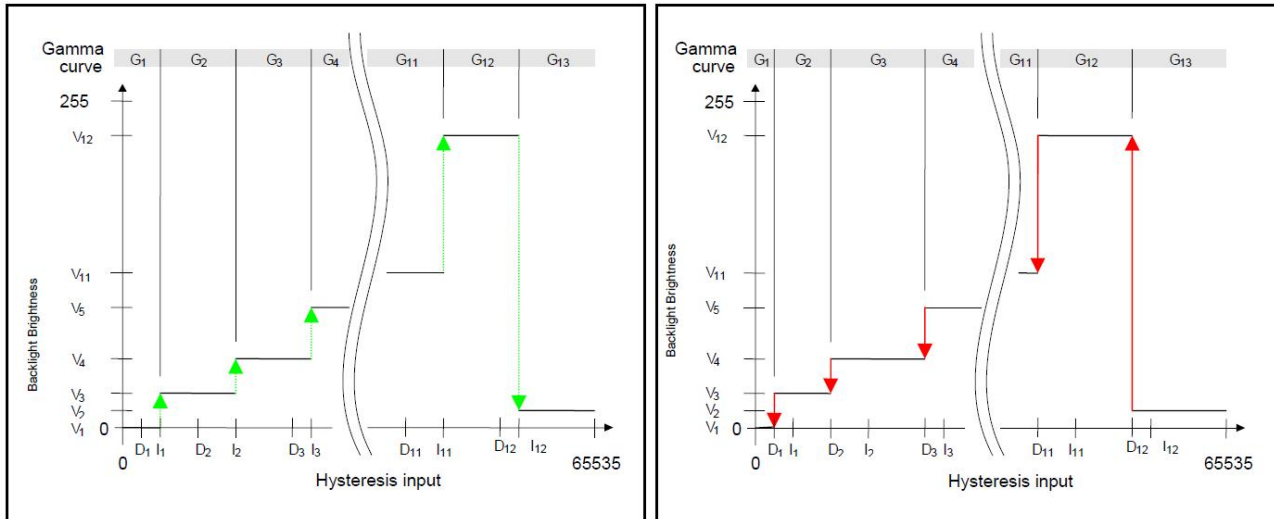

The following example is using 6 steps (6 increment and 6 decrement) for hysteresis 6.

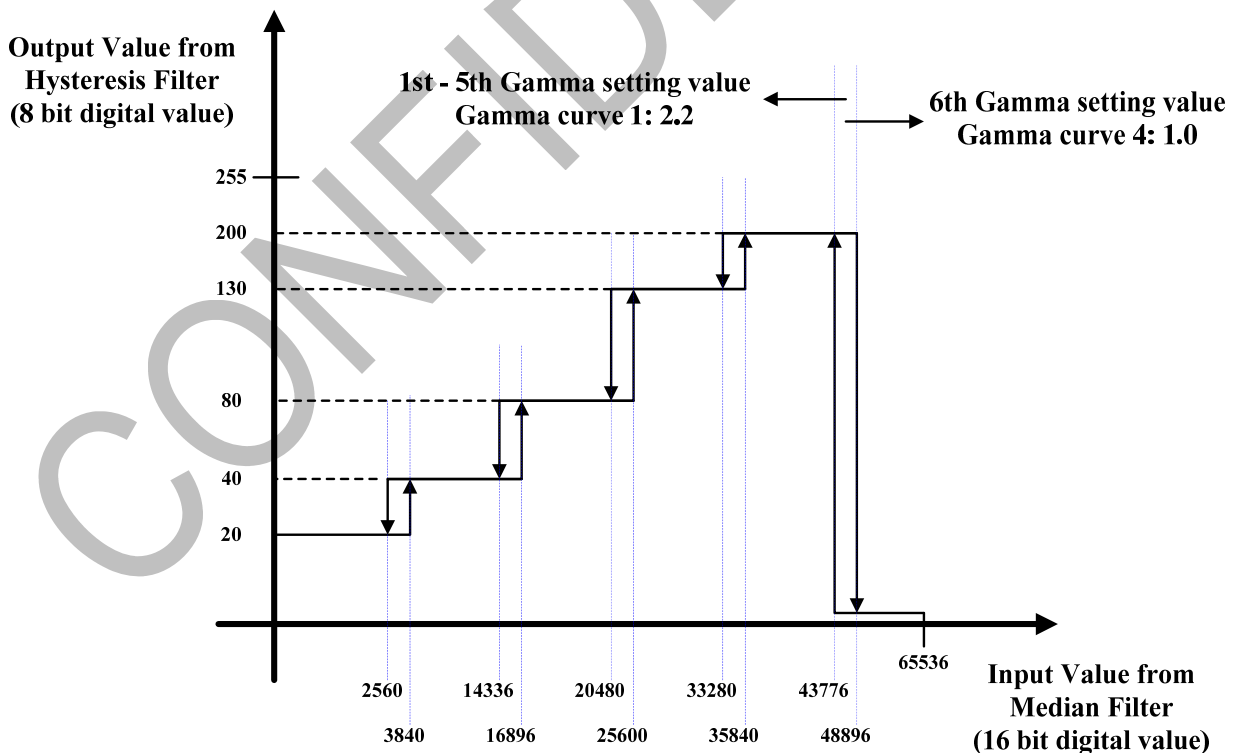

The following table is specified the relationship between each parameters and step numbers as the above example of hysteresis and profiles.

Step number (n)	Increment Value (In)	Decrement Value (Dn)	Display Brightness (Vn)	Gamma Curve (Gn)
1	3840(F00h)	2560(A00h)	20(14h)	2.2(1h)
2	16896(4200h)	14336(3800h)	40(28h)	2.2(1h)
3	25600(6400h)	20480(5000h)	80(50h)	2.2(1h)
4	35840(8C00h)	33280(8200h)	130(82h)	2.2(1h)
5	48896(BF00h)	43776(AB00h)	200(C8h)	2.2(1h)
6	65535(FFFFh)	65535(FFFFh)	0	1.0(8h)
7	X	X	X	X
8	X	X	X	X
9	X	X	X	X
10	X	X	X	X
11	X	X	X	X
12	X	X	X	X
13	X	X	X	X
14	X	X	X	X
15	X	X	X	X
16	X	X	X	X

Step number of increment-value and decrement-value is 16 steps. Don't care about the parameter values after "65535 (FFFFh)" of increment value and decrement value, e.g. "X" in the above table. 16th increment and decrement values are always set to "65535 (FFFFh)" internally, if increment and decrement values before 16th parameters are less than "65535 (FFFFh)".

Once the hysteresis curve has been stored using the commands above, the flowchart is used to select the correct hysteresis level after getting median filter output as a reference. Flow chart for adjust correct hysteresis level is as below one.

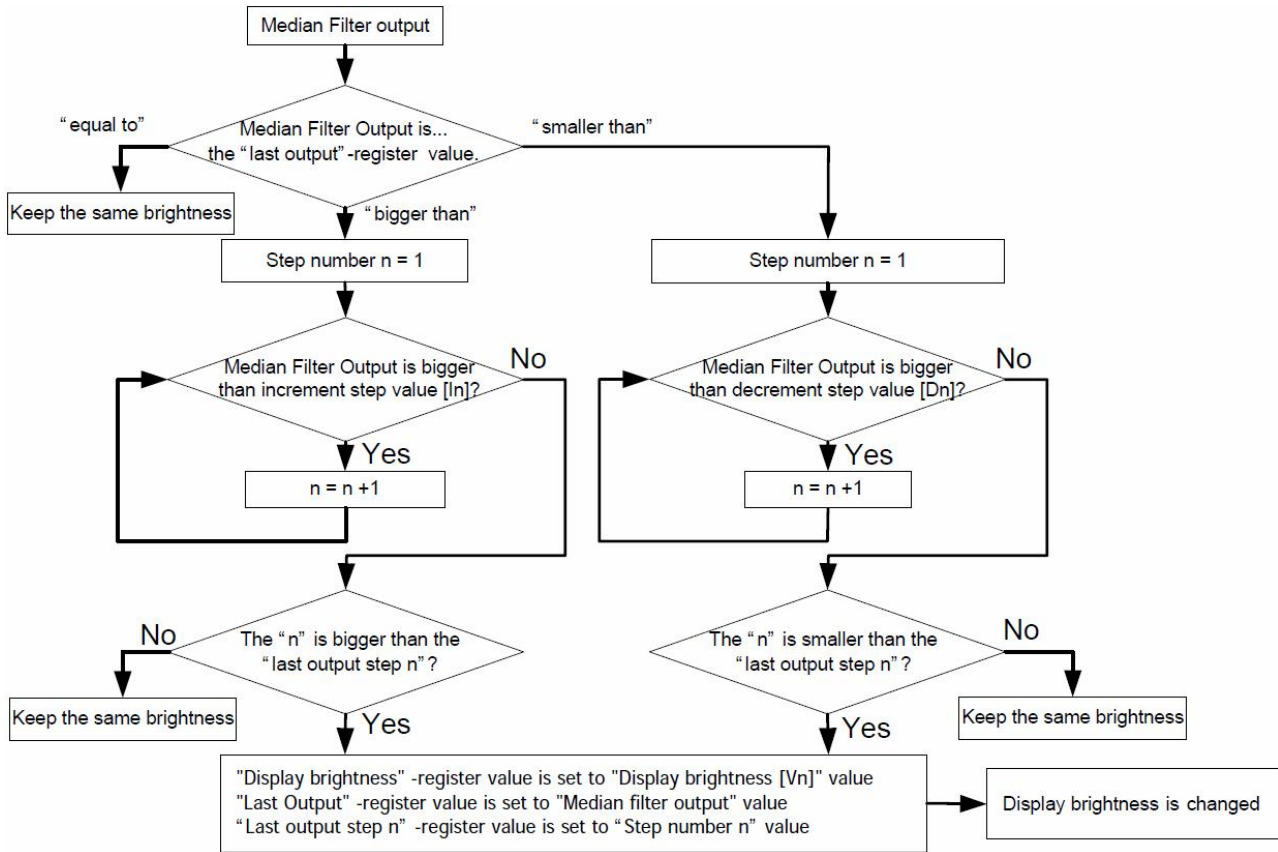

CONFIDENTIAL

8. Command

8.1. Command List

Operational Code (Hex)	Command	Command(C) /Read(R) /Write(W)	Number Of Parameter
00h	nop	C	0
01h	soft_reset	C	0
04h	get_display_ID	R	3
05h	get_DSI_err	R	1
0Ah	get_power_mode	R	1
0Bh	get_address_mode	R	1
0Ch	get_pixel format	R	1
0Dh	get_display_mode	R	1
0Eh	get_signal mode	R	1
0Fh	get_diagnostic_result	R	1
10h	enter_sleep_mode	C	0
11h	exit_sleep_mode	C	0
12h	enter_partial_mode	C	0
13h	enter_normal_mode	C	0
20h	exit_invert_mode	C	0
21h	enter_invert_mode	C	0
22h	set_all_pixel_off	C	0
23h	set_all_pixel_on	C	0
26h	Gamma_curve_select	W	1
28h	set_display_off	C	0
29h	set_display_on	C	0
2Ah	set_column_address	W	4
2Bh	set_page_address	W	4
2Ch	write_memory_start	W	Variable
2Eh	read_memory_start	R	Variable
30h	set_partial_area	W	4
33h	set_scroll_area	W	6
34h	set_tear_off	C	0
35h	set_tear_on	W	1
36h	set_address_mode	W	1
38h	exit_idle_mode	C	0
39h	enter_idle_mode	C	0
3Ah	set_pixel format	W	1
3Ch	write_memory_continue	W	Variable
3Eh	read_memory_continue	R	Variable
44h	set_tear_scanline	W	2
45h	get_scanline	R	2
4Fh	set_deep_standby_mode	W	1

Operational Code (Hex)	Command	Command(C) /Read(R) /Write(W)	Number Of Parameter
50h	set_profile_value_for_display	W	16
51h	set_display_brightness	W	1
52h	get_display_brightness	R	1
53h	set_control_display	W	1
54h	get_control_display	R	1
55h	set_cabc_mode	W	1
56h	get_cabc_mode	R	1
57h	set_hysteresis	W	32
58h	set_gamma_setting	W	8
5Ah	get_FS_value_MSBs	R	1
5Bh	get_FS_value_LSBs	R	1
5Ch	get_median_filter_FS_value_MSBs	R	1
5Dh	get_median_filter_FS_value_LSBs	R	1
5Eh	set_cabc_min_brightness	W	1
5Fh	get_cabc_min_brightness	R	1
65h	set_light_sensor_compensation_coefficient	W	2
66h	get_LSCC_MSBs	R	1
67h	get_LSCC_LSBs	R	1
70h	get_black/white low bit	R	1
71h	get_Bkx	R	1
72h	get_Bky	R	1
73h	get_Wx	R	1
74h	get_Wy	R	1
75h	get_red/green low bit	R	1
76h	get_Rx	R	1
77h	get_Ry	R	1
78h	get_Gx	R	1
79h	get_Gy	R	1
7Ah	get_blue/Acolor low bit	R	1
7Bh	get_Bx	R	1
7Ch	get_By	R	1
7Dh	get_Ax	R	1
7Eh	get_Ay	R	1
A1h	read_DDB_start	R	5
A8h	read_DDB_continue	R	5
AAh	read_first_checksum	R	1
AFh	read_continue_checksum	R	1
DAh	read_ID1	R	1
DBh	read_ID2	R	1
DCh	read_ID3	R	1

8.2. Command Description

NOP (0000h)

0000H	NOP (No Operation)																								
	DCX	RDX	WRX	D17-D8	D7	D6	D5	D4	D3	D2	D1	D0	HEX												
Command	0	1	↑	X	0	0	0	0	0	0	0	0	00												
Parameter	NO PARAMETER																								
Description	<p>This command is an empty command; it does not have any effect on the display module. However it can be used to terminate Frame Memory Write or Read as described in RAMWR (Memory Write) and RAMRD (Memory Read) Commands.</p> <p>X = Don't care.</p>																								
Restriction	None																								
Register Availability	<table border="1"> <thead> <tr> <th>Status</th> <th>Availability</th> </tr> </thead> <tbody> <tr> <td>Normal Mode On, Idle Mode Off, Sleep Out</td> <td>Yes</td> </tr> <tr> <td>Normal Mode On, Idle Mode On, Sleep Out</td> <td>Yes</td> </tr> <tr> <td>Partial Mode On, Idle Mode Off, Sleep Out</td> <td>Yes</td> </tr> <tr> <td>Partial Mode On, Idle Mode On, Sleep Out</td> <td>Yes</td> </tr> <tr> <td>Sleep In</td> <td>Yes</td> </tr> </tbody> </table>													Status	Availability	Normal Mode On, Idle Mode Off, Sleep Out	Yes	Normal Mode On, Idle Mode On, Sleep Out	Yes	Partial Mode On, Idle Mode Off, Sleep Out	Yes	Partial Mode On, Idle Mode On, Sleep Out	Yes	Sleep In	Yes
Status	Availability																								
Normal Mode On, Idle Mode Off, Sleep Out	Yes																								
Normal Mode On, Idle Mode On, Sleep Out	Yes																								
Partial Mode On, Idle Mode Off, Sleep Out	Yes																								
Partial Mode On, Idle Mode On, Sleep Out	Yes																								
Sleep In	Yes																								
Default	<table border="1"> <thead> <tr> <th>Status</th> <th>Default Value</th> </tr> </thead> <tbody> <tr> <td>Power On Sequence</td> <td>N/A</td> </tr> <tr> <td>SW Reset</td> <td>N/A</td> </tr> <tr> <td>HW Reset</td> <td>N/A</td> </tr> </tbody> </table>													Status	Default Value	Power On Sequence	N/A	SW Reset	N/A	HW Reset	N/A				
Status	Default Value																								
Power On Sequence	N/A																								
SW Reset	N/A																								
HW Reset	N/A																								
Flow Chart	None																								

SWRESET(0100h) : Software Reset

0100H	SWRESET(Software Reset)																								
	DCX	RDX	WRX	D15-D8	D7	D6	D5	D4	D3	D2	D1	D0	HEX												
Command	0	1	↑	X	0	0	0	0	0	0	0	1	01												
Parameter	NO PARAMETER																								
Description	<p>When the Software Reset command is written, it causes software reset. It resets the commands and parameters to their S/W Reset default values. (See default tables in each command description.)</p> <p>Note: The Frame Memory contents are affected by this command.</p> <p>X = Don't care</p>																								
Restriction	<p>Software Reset Command cannot be sent during Sleep Out sequence.</p> <p>Any new command is cannot be sent for 10-frame period until the RM68120 enters Sleep-In mode. Do not send any command.</p>																								
Register Availability	<table border="1"> <thead> <tr> <th>Status</th> <th>Availability</th> </tr> </thead> <tbody> <tr> <td>Normal Mode On, Idle Mode Off, Sleep Out</td> <td>Yes</td> </tr> <tr> <td>Normal Mode On, Idle Mode On, Sleep Out</td> <td>Yes</td> </tr> <tr> <td>Partial Mode On, Idle Mode Off, Sleep Out</td> <td>Yes</td> </tr> <tr> <td>Partial Mode On, Idle Mode On, Sleep Out</td> <td>Yes</td> </tr> <tr> <td>Sleep In</td> <td>Yes</td> </tr> </tbody> </table>													Status	Availability	Normal Mode On, Idle Mode Off, Sleep Out	Yes	Normal Mode On, Idle Mode On, Sleep Out	Yes	Partial Mode On, Idle Mode Off, Sleep Out	Yes	Partial Mode On, Idle Mode On, Sleep Out	Yes	Sleep In	Yes
Status	Availability																								
Normal Mode On, Idle Mode Off, Sleep Out	Yes																								
Normal Mode On, Idle Mode On, Sleep Out	Yes																								
Partial Mode On, Idle Mode Off, Sleep Out	Yes																								
Partial Mode On, Idle Mode On, Sleep Out	Yes																								
Sleep In	Yes																								
Default	<table border="1"> <thead> <tr> <th>Status</th> <th>Default Value</th> </tr> </thead> <tbody> <tr> <td>Power On Sequence</td> <td>N/A</td> </tr> <tr> <td>SW Reset</td> <td>N/A</td> </tr> <tr> <td>HW Reset</td> <td>N/A</td> </tr> </tbody> </table>													Status	Default Value	Power On Sequence	N/A	SW Reset	N/A	HW Reset	N/A				
Status	Default Value																								
Power On Sequence	N/A																								
SW Reset	N/A																								
HW Reset	N/A																								

Flow Chart

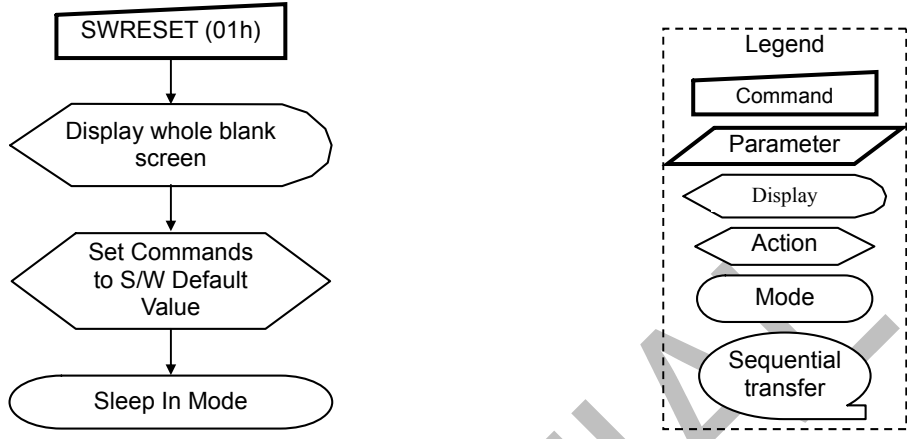

CONFIDENTIAL

RDDID(0400h~0402h) : Read Display ID

0400H	RDDID																										
	DCX	RDX	WRX	D15-D8	D7	D6	D5	D4	D3	D2	D1	D0	HEX														
Command	0	1	↑	00h	0	0	0	0	0	1	0	0	04														
1 st	1	↑	1	x	x	x	x	x	x	x	x	x	x														
2 nd	1	↑	1	00h	ID17	ID16	ID15	ID14	ID13	ID12	ID11	ID10	00														
3 rd	1	↑	1	00h	ID27	ID26	ID25	ID24	ID23	ID22	ID21	ID20	80														
4 th	1	↑	1	00h	ID37	ID36	ID35	ID34	ID33	ID32	ID31	ID30	00														
Parameter	-																										
Description	<p>The 1st parameter (ID1): the module's manufacture ID</p> <p>The 2nd parameter (ID2): the module/driver version ID</p> <p>The 3rd parameter (ID3): the module/driver ID</p> <p>Note: Commands RDID1/2/3 (DAh/DBh/DCh) read data correspond to the parameter 1, 2, 3 of command 04h, respectively.</p>																										
Restriction	-																										
Register Availability	<table border="1"> <thead> <tr> <th>Status</th> <th>Availability</th> </tr> </thead> <tbody> <tr> <td>Normal Mode On, Idle Mode Off, Sleep Out</td> <td>Yes</td> </tr> <tr> <td>Normal Mode On, Idle Mode On, Sleep Out</td> <td>Yes</td> </tr> <tr> <td>Partial Mode On, Idle Mode Off, Sleep Out</td> <td>Yes</td> </tr> <tr> <td>Partial Mode On, Idle Mode On, Sleep Out</td> <td>Yes</td> </tr> <tr> <td>Sleep In</td> <td>Yes</td> </tr> </tbody> </table>													Status	Availability	Normal Mode On, Idle Mode Off, Sleep Out	Yes	Normal Mode On, Idle Mode On, Sleep Out	Yes	Partial Mode On, Idle Mode Off, Sleep Out	Yes	Partial Mode On, Idle Mode On, Sleep Out	Yes	Sleep In	Yes		
Status	Availability																										
Normal Mode On, Idle Mode Off, Sleep Out	Yes																										
Normal Mode On, Idle Mode On, Sleep Out	Yes																										
Partial Mode On, Idle Mode Off, Sleep Out	Yes																										
Partial Mode On, Idle Mode On, Sleep Out	Yes																										
Sleep In	Yes																										
Default	<table border="1"> <thead> <tr> <th rowspan="2">Status</th> <th colspan="2">Default Value</th> </tr> <tr> <th>After MTP</th> <th>Before MTP</th> </tr> </thead> <tbody> <tr> <td>Power On Sequence</td> <td>MTP value</td> <td>ID1=00h / ID2=80h / ID3=00h</td> </tr> <tr> <td>SW Reset</td> <td>MTP value</td> <td>ID1=00h / ID2=80h / ID3=00h</td> </tr> <tr> <td>HW Reset</td> <td>MTP value</td> <td>ID1=00h / ID2=80h / ID3=00h</td> </tr> </tbody> </table>													Status	Default Value		After MTP	Before MTP	Power On Sequence	MTP value	ID1=00h / ID2=80h / ID3=00h	SW Reset	MTP value	ID1=00h / ID2=80h / ID3=00h	HW Reset	MTP value	ID1=00h / ID2=80h / ID3=00h
Status	Default Value																										
	After MTP	Before MTP																									
Power On Sequence	MTP value	ID1=00h / ID2=80h / ID3=00h																									
SW Reset	MTP value	ID1=00h / ID2=80h / ID3=00h																									
HW Reset	MTP value	ID1=00h / ID2=80h / ID3=00h																									

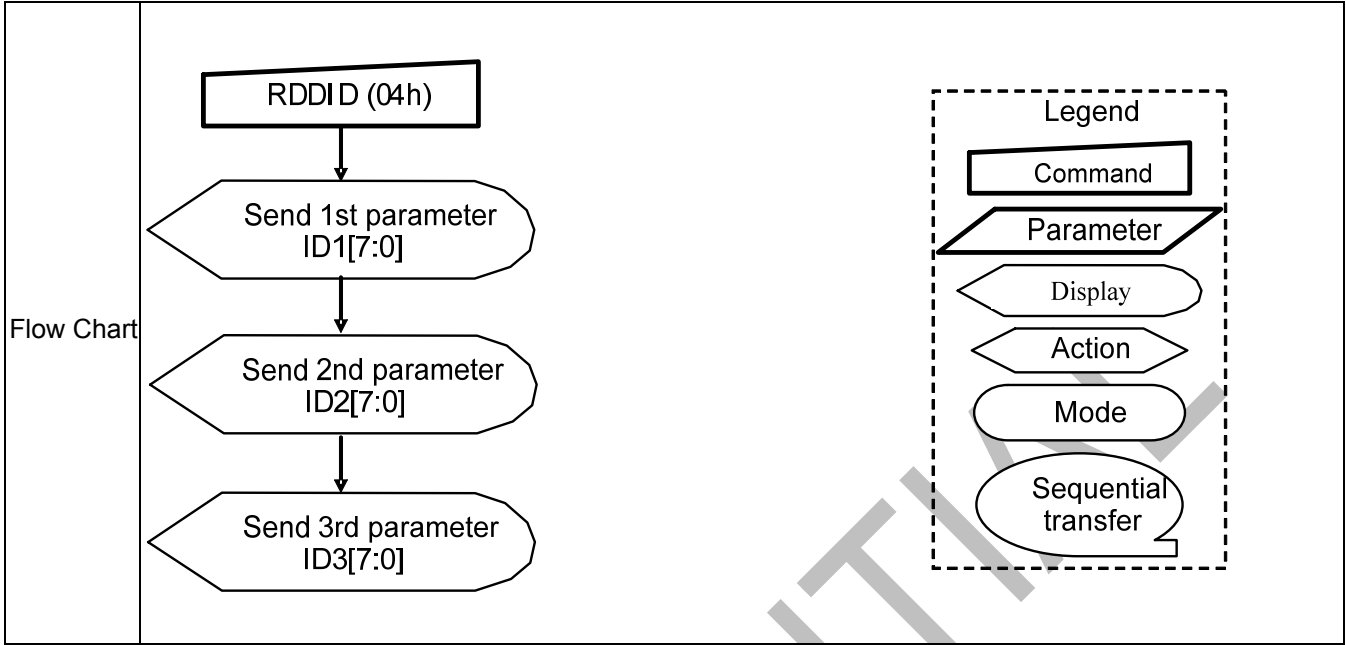

RDNUMED(0500h) : Read Number of Errors on DSI

0500H	RDNUMED																								
	DCX	RDX	WRX	D15-D8	D7	D6	D5	D4	D3	D2	D1	D0	HEX												
Command	0	1	↑	X	0	0	0	0	0	1	0	1	05												
1 st	1	↑	1	x	x	x	x	x	x	x	x	x	x												
2 nd	1	↑	1	x	P7	P6	P5	P4	P3	P2	P1	P0	00												
Parameter	NO PARAMETER																								
Description	<p>The first parameter is telling a number of the parity errors on DSI. The more detailed description of the bits is below.</p> <p>P[6..0] bits are telling a number of the parity errors.</p> <p>P[7] is set to "1" if there is overflow with P[6..0] bits.</p> <p>P[7..0] bits are set to "0"s (as well as RDDSM(0Eh)'s D0 are set "0" at the same time) after there is sent the first parameter information (= The read function is completed).</p> <p>This command is used for MIPI DSI only. It is no function for others interface operation.</p>																								
Restriction	-																								
Register Availability	<table border="1"> <thead> <tr> <th>Status</th> <th>Availability</th> </tr> </thead> <tbody> <tr> <td>Normal Mode On, Idle Mode Off, Sleep Out</td> <td>Yes</td> </tr> <tr> <td>Normal Mode On, Idle Mode On, Sleep Out</td> <td>Yes</td> </tr> <tr> <td>Partial Mode On, Idle Mode Off, Sleep Out</td> <td>Yes</td> </tr> <tr> <td>Partial Mode On, Idle Mode On, Sleep Out</td> <td>Yes</td> </tr> <tr> <td>Sleep In</td> <td>Yes</td> </tr> </tbody> </table>													Status	Availability	Normal Mode On, Idle Mode Off, Sleep Out	Yes	Normal Mode On, Idle Mode On, Sleep Out	Yes	Partial Mode On, Idle Mode Off, Sleep Out	Yes	Partial Mode On, Idle Mode On, Sleep Out	Yes	Sleep In	Yes
Status	Availability																								
Normal Mode On, Idle Mode Off, Sleep Out	Yes																								
Normal Mode On, Idle Mode On, Sleep Out	Yes																								
Partial Mode On, Idle Mode Off, Sleep Out	Yes																								
Partial Mode On, Idle Mode On, Sleep Out	Yes																								
Sleep In	Yes																								
Default	<table border="1"> <thead> <tr> <th>Status</th> <th>Default Value</th> </tr> </thead> <tbody> <tr> <td>Power On Sequence</td> <td>00h</td> </tr> <tr> <td>SW Reset</td> <td>00h</td> </tr> <tr> <td>HW Reset</td> <td>00h</td> </tr> </tbody> </table>													Status	Default Value	Power On Sequence	00h	SW Reset	00h	HW Reset	00h				
Status	Default Value																								
Power On Sequence	00h																								
SW Reset	00h																								
HW Reset	00h																								

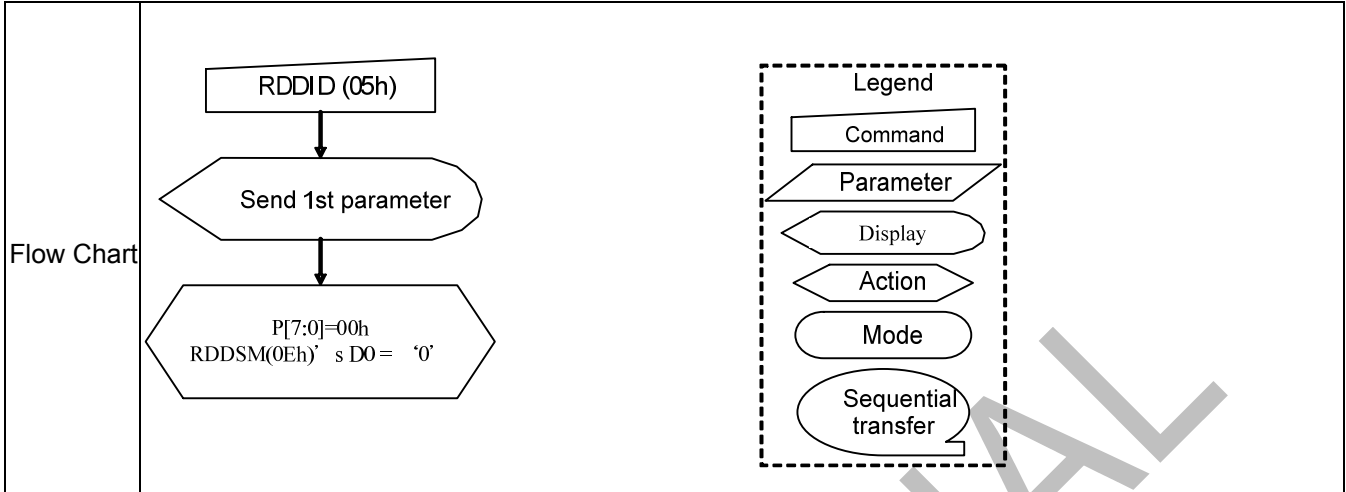

CONFIDENTIAL

RDDPM (0A00h) : Read Display Power Mode

0A00H	RDDPM (Read Display Power Mode)																																																
	DCX	RDX	WRX	D15-8	D7	D6	D5	D4	D3	D2	D1	D0	HEX																																				
Command	0	1	↑	x	0	0	0	0	1	0	1	0	0A																																				
1 st parameter	1	↑	1	x	x	x	x	x	x	x	x	x	x																																				
2 nd parameter	1	↑	1	x	D7	D6	D5	D4	D3	D2	D1	D0	08																																				
Description	<p>This command indicates the current status of the display as described in the table below:</p> <table border="1"> <thead> <tr> <th>Bit</th> <th>Symbol</th> <th>Description</th> <th>Comment</th> </tr> </thead> <tbody> <tr> <td>D7</td> <td>BSTON</td> <td>Booster Voltage Status</td> <td>'1'=Booster on, '0'=Booster off</td> </tr> <tr> <td>D6</td> <td>IDMON</td> <td>Idle Mode On/Off</td> <td>'1' = Idle Mode On, '0' = Idle Mode Off</td> </tr> <tr> <td>D5</td> <td>PTLON</td> <td>Partial Mode On/Off</td> <td>'1' = Partial Mode On, '0' = Partial Mode Off</td> </tr> <tr> <td>D4</td> <td>SLPON</td> <td>Sleep In/Out</td> <td>'1' = Sleep Out, '0' = Sleep In</td> </tr> <tr> <td>D3</td> <td>NORON</td> <td>Display Normal Mode On/Off</td> <td>'1' = Normal Display, '0' = Partial Display</td> </tr> <tr> <td>D2</td> <td>DISON</td> <td>Display On/Off</td> <td>'1' = Display On, '0' = Display Off</td> </tr> <tr> <td>D1</td> <td>Reserved</td> <td></td> <td>0</td> </tr> <tr> <td>D0</td> <td>Reserved</td> <td></td> <td>0</td> </tr> </tbody> </table>													Bit	Symbol	Description	Comment	D7	BSTON	Booster Voltage Status	'1'=Booster on, '0'=Booster off	D6	IDMON	Idle Mode On/Off	'1' = Idle Mode On, '0' = Idle Mode Off	D5	PTLON	Partial Mode On/Off	'1' = Partial Mode On, '0' = Partial Mode Off	D4	SLPON	Sleep In/Out	'1' = Sleep Out, '0' = Sleep In	D3	NORON	Display Normal Mode On/Off	'1' = Normal Display, '0' = Partial Display	D2	DISON	Display On/Off	'1' = Display On, '0' = Display Off	D1	Reserved		0	D0	Reserved		0
	Bit	Symbol	Description	Comment																																													
	D7	BSTON	Booster Voltage Status	'1'=Booster on, '0'=Booster off																																													
	D6	IDMON	Idle Mode On/Off	'1' = Idle Mode On, '0' = Idle Mode Off																																													
	D5	PTLON	Partial Mode On/Off	'1' = Partial Mode On, '0' = Partial Mode Off																																													
	D4	SLPON	Sleep In/Out	'1' = Sleep Out, '0' = Sleep In																																													
	D3	NORON	Display Normal Mode On/Off	'1' = Normal Display, '0' = Partial Display																																													
	D2	DISON	Display On/Off	'1' = Display On, '0' = Display Off																																													
	D1	Reserved		0																																													
	D0	Reserved		0																																													
Register Availability	<table border="1"> <thead> <tr> <th>Status</th> <th>Availability</th> </tr> </thead> <tbody> <tr> <td>Normal Mode On, Idle Mode Off, Sleep Out</td> <td>Yes</td> </tr> <tr> <td>Normal Mode On, Idle Mode On, Sleep Out</td> <td>Yes</td> </tr> <tr> <td>Partial Mode On, Idle Mode Off, Sleep Out</td> <td>Yes</td> </tr> <tr> <td>Partial Mode On, Idle Mode On, Sleep Out</td> <td>Yes</td> </tr> <tr> <td>Sleep In</td> <td>Yes</td> </tr> </tbody> </table>													Status	Availability	Normal Mode On, Idle Mode Off, Sleep Out	Yes	Normal Mode On, Idle Mode On, Sleep Out	Yes	Partial Mode On, Idle Mode Off, Sleep Out	Yes	Partial Mode On, Idle Mode On, Sleep Out	Yes	Sleep In	Yes																								
	Status	Availability																																															
	Normal Mode On, Idle Mode Off, Sleep Out	Yes																																															
	Normal Mode On, Idle Mode On, Sleep Out	Yes																																															
	Partial Mode On, Idle Mode Off, Sleep Out	Yes																																															
	Partial Mode On, Idle Mode On, Sleep Out	Yes																																															
Sleep In	Yes																																																

Default	<table border="1"> <thead> <tr> <th>Status</th> <th>Default Value</th> </tr> </thead> <tbody> <tr> <td>Power On Sequence</td> <td>08h</td> </tr> <tr> <td>SW Reset</td> <td>08h</td> </tr> <tr> <td>HW Reset</td> <td>08h</td> </tr> </tbody> </table>		Status	Default Value	Power On Sequence	08h	SW Reset	08h	HW Reset	08h
	Status	Default Value								
	Power On Sequence	08h								
	SW Reset	08h								
HW Reset	08h									
<p>Flow Chart</p> <pre> graph TD subgraph Host S1[RDDPM (0Ah)] S2[RDDPM (0Ah)] end subgraph Driver D1[/Send D[7:0]/] D2[/Dummy Read/] D3[/Send D[7:0]/] end S1 --> D1 S2 --> D2 D2 --> D3 </pre> <p>Legend</p> <ul style="list-style-type: none"> Command Parameter Display Action Mode Sequential transfer 										

RDDMADCTR (0B00h): Read Display MADCTR

0B00H	RDDMADCTR (Read Display MADCTR)																																																
	DCX	RDX	WRX	D15-0	D7	D6	D5	D4	D3	D2	D1	D0	HEX																																				
Command	0	1	↑	x	0	0	0	0	1	0	1	1	0B																																				
1 st parameter	1	↑	1	x	x	x	x	x	x	x	x	x	x																																				
2 nd parameter	1	↑	1	x	D7	D6	D5	D4	D3	D2	D1	D0	00																																				
Description	This command indicates the current status of the display as described in the table below:																																																
	<table border="1"> <thead> <tr> <th>Bit</th> <th>Symbol</th> <th>Description</th> <th>Comment</th> </tr> </thead> <tbody> <tr> <td>D7</td> <td>MY</td> <td>Row Address Order</td> <td>'1' = Bottom to Top (36H-D7='1') '0' = Top to Bottom (36H-D7='0')</td> </tr> <tr> <td>D6</td> <td>MX</td> <td>Column Address Order</td> <td>'1' = Right to Left (MADCTL D6='1') '0' = Left to Right (MADCTL D6='0')</td> </tr> <tr> <td>D5</td> <td>MV</td> <td>Row/Column Order (MV)</td> <td>'1' = Row/column exchange(36H-D5='1') '0' = Normal (36H-D5='0')</td> </tr> <tr> <td>D4</td> <td>ML</td> <td>Vertical Refresh Order</td> <td>'1' =LCD Refresh Top to Bottom '0' =LCD Refresh Bottom to Top</td> </tr> <tr> <td>D3</td> <td>RGB</td> <td>RGB/BGR Order</td> <td>'1' =BGR, "0"=RGB</td> </tr> <tr> <td>D2</td> <td>MH</td> <td>Horizontal Refresh Order</td> <td>'0' = LCD Refresh Left to Right '1' = LCD Refresh Right to Left</td> </tr> <tr> <td>D1</td> <td>RSMX</td> <td>Horizontal Flip</td> <td>'0' = Normal display(36H-D1='1') '1' = Flipped display(36H-D1='1')</td> </tr> <tr> <td>D0</td> <td>RSMY</td> <td>Vertical Flip</td> <td>'0' = Normal display(36H-D0='1') '1' = Flipped display(36H-D0='1')</td> </tr> </tbody> </table>													Bit	Symbol	Description	Comment	D7	MY	Row Address Order	'1' = Bottom to Top (36H-D7='1') '0' = Top to Bottom (36H-D7='0')	D6	MX	Column Address Order	'1' = Right to Left (MADCTL D6='1') '0' = Left to Right (MADCTL D6='0')	D5	MV	Row/Column Order (MV)	'1' = Row/column exchange(36H-D5='1') '0' = Normal (36H-D5='0')	D4	ML	Vertical Refresh Order	'1' =LCD Refresh Top to Bottom '0' =LCD Refresh Bottom to Top	D3	RGB	RGB/BGR Order	'1' =BGR, "0"=RGB	D2	MH	Horizontal Refresh Order	'0' = LCD Refresh Left to Right '1' = LCD Refresh Right to Left	D1	RSMX	Horizontal Flip	'0' = Normal display(36H-D1='1') '1' = Flipped display(36H-D1='1')	D0	RSMY	Vertical Flip	'0' = Normal display(36H-D0='1') '1' = Flipped display(36H-D0='1')
	Bit	Symbol	Description	Comment																																													
	D7	MY	Row Address Order	'1' = Bottom to Top (36H-D7='1') '0' = Top to Bottom (36H-D7='0')																																													
	D6	MX	Column Address Order	'1' = Right to Left (MADCTL D6='1') '0' = Left to Right (MADCTL D6='0')																																													
	D5	MV	Row/Column Order (MV)	'1' = Row/column exchange(36H-D5='1') '0' = Normal (36H-D5='0')																																													
	D4	ML	Vertical Refresh Order	'1' =LCD Refresh Top to Bottom '0' =LCD Refresh Bottom to Top																																													
	D3	RGB	RGB/BGR Order	'1' =BGR, "0"=RGB																																													
	D2	MH	Horizontal Refresh Order	'0' = LCD Refresh Left to Right '1' = LCD Refresh Right to Left																																													
	D1	RSMX	Horizontal Flip	'0' = Normal display(36H-D1='1') '1' = Flipped display(36H-D1='1')																																													
D0	RSMY	Vertical Flip	'0' = Normal display(36H-D0='1') '1' = Flipped display(36H-D0='1')																																														
Register Availability	<table border="1"> <thead> <tr> <th>Status</th> <th>Availability</th> </tr> </thead> <tbody> <tr> <td>Normal Mode On, Idle Mode Off, Sleep Out</td> <td>Yes</td> </tr> <tr> <td>Normal Mode On, Idle Mode On, Sleep Out</td> <td>Yes</td> </tr> <tr> <td>Partial Mode On, Idle Mode Off, Sleep Out</td> <td>Yes</td> </tr> <tr> <td>Partial Mode On, Idle Mode On, Sleep Out</td> <td>Yes</td> </tr> <tr> <td>Sleep In</td> <td>Yes</td> </tr> </tbody> </table>													Status	Availability	Normal Mode On, Idle Mode Off, Sleep Out	Yes	Normal Mode On, Idle Mode On, Sleep Out	Yes	Partial Mode On, Idle Mode Off, Sleep Out	Yes	Partial Mode On, Idle Mode On, Sleep Out	Yes	Sleep In	Yes																								
	Status	Availability																																															
	Normal Mode On, Idle Mode Off, Sleep Out	Yes																																															
	Normal Mode On, Idle Mode On, Sleep Out	Yes																																															
	Partial Mode On, Idle Mode Off, Sleep Out	Yes																																															
	Partial Mode On, Idle Mode On, Sleep Out	Yes																																															
Sleep In	Yes																																																

<p>Default</p>	<table border="1"> <thead> <tr> <th>Status</th> <th>Default Value</th> </tr> </thead> <tbody> <tr> <td>Power On Sequence</td> <td>00h</td> </tr> <tr> <td>SW Reset</td> <td>No Change</td> </tr> <tr> <td>HW Reset</td> <td>00h</td> </tr> </tbody> </table>	Status	Default Value	Power On Sequence	00h	SW Reset	No Change	HW Reset	00h
Status	Default Value								
Power On Sequence	00h								
SW Reset	No Change								
HW Reset	00h								
<p>Flow Chart</p>	<p>The flowchart is divided into two sections: Serial I/F Mode and Parallel I/F Mode, separated by a horizontal dashed line labeled 'Host' above and 'Driver' below. In Serial I/F Mode, a Command box 'RDDMADCTR (0Bh)' points to a Parameter parallelogram 'Send D[7:0]'. In Parallel I/F Mode, a Command box 'RDDMADCTR (0Bh)' points to an Action arrowhead 'Dummy Read', which then points to a Parameter parallelogram 'Send D[7:0]'. A legend on the right defines the symbols: Command (rectangle), Parameter (parallelogram), Display (oval), Action (arrowhead), Mode (rounded rectangle), and Sequential transfer (speech bubble).</p>								

RDDCOLMOD (0C00h): Read Display Pixel Format

0C00H	RDDCOLMOD (Read Display Pixel Format)												HEX
	DCX	RDX	WRX	D15-8	D7	D6	D5	D4	D3	D2	D1	D0	
Command	0	1	↑	x	0	0	0	0	1	1	0	0	0C
1 st parameter	1	↑	1	x	x	x	x	x	x	x	x	x	x
2 nd parameter	1	↑	1	x	D7	D6	D5	D4	D3	D2	D1	D0	66
Description	This command indicates the current status of the display as described in the table below:												
	Bit	Symbol	Description		Comment								
	D7	Reserved			'0'								
	D6	VIPF[2]	DPI Pixel Format(RGB Interface Color Format)		'101' = 16-bits / pixel, '110' = 18-bits / pixel, '111' = 24-bits / pixel, others are no define								
	D5	VIPF[1]											
	D4	VIPF[0]											
	D3	Reserved			'0'								
	D2	IFPF[2]	DBI Pixel Format(Control Interface Color Format)		'101' = 16-bits / pixel, '110' = 18-bits / pixel, '111' = 24-bits / pixel, others are no define								
	D1	IFPF[1]											
	D0	IFPF[0]											
Register Availability	Status		Availability										
	Normal Mode On, Idle Mode Off, Sleep Out		Yes										
	Normal Mode On, Idle Mode On, Sleep Out		Yes										
	Partial Mode On, Idle Mode Off, Sleep Out		Yes										
	Partial Mode On, Idle Mode On, Sleep Out		Yes										
	Sleep In		Yes										

<p>Default</p>	<table border="1"> <thead> <tr> <th>Status</th> <th>Default Value</th> </tr> </thead> <tbody> <tr> <td>Power On Sequence</td> <td>66h</td> </tr> <tr> <td>SW Reset</td> <td>No Change</td> </tr> <tr> <td>HW Reset</td> <td>66h</td> </tr> </tbody> </table>	Status	Default Value	Power On Sequence	66h	SW Reset	No Change	HW Reset	66h
Status	Default Value								
Power On Sequence	66h								
SW Reset	No Change								
HW Reset	66h								
<p>Flow Chart</p>	<p>The flow chart illustrates the sequence of operations for the RDDCOLMOD (0Ch) command in two modes:</p> <ul style="list-style-type: none"> Serial I/F Mode: The command RDDCOLMOD (0Ch) is sent from the Host to the Driver. This is followed by the parameter Send D[7:0] being sent from the Driver back to the Host. Parallel I/F Mode: The command RDDCOLMOD (0Ch) is sent from the Host to the Driver. This is followed by a Dummy Read action performed by the Driver, which then sends the parameter Send D[7:0] back to the Host. <p>A dashed horizontal line separates the Host (top) from the Driver (bottom). A legend on the right defines the symbols used in the flow chart:</p> <ul style="list-style-type: none"> Command: Rectangle Parameter: Parallelogram Display: Trapezoid Action: Arrowhead Mode: Oval Sequential transfer: Oval with tail 								

RDDIM (0D00h): Read Display Image Mode

0D00H	RDDIM (Read Display Image Mode)												
	DCX	RDX	WRX	D15-8	D7	D6	D5	D4	D3	D2	D1	D0	HEX
Command	0	1	↑	x	0	0	0	0	1	1	0	1	0D
1 st Parameter	1	↑	1	x	x	x	x	x	x	x	x	x	x
2 nd Parameter	1	↑	1	x	D7	D6	D5	D4	D3	D2	D1	D0	00
Description	The display module returns the display image mode status.												
	Bit	Symbol	Description		Comment								
	D7	Reserved			'0'								
	D6	Reserved			'0'								
	D5	INVON	Inversion On/Off		"1" = Inversion is On, "0" = Inversion is Off								
	D4	ALLON	All Pixel On		'0' = Normal display '1' = White display								
	D3	ALLOFF	All Pixel Off		'0' = Normal display '1' = Black display								
	D2~D0	GAMSET	Gamma Curve Selection		'000' = GC0, '001' = GC1 '010' = GC2, '011' = GC3								
Register Availability	Status		Availability										
	Normal Mode On, Idle Mode Off, Sleep Out		Yes										
	Normal Mode On, Idle Mode On, Sleep Out		Yes										
	Partial Mode On, Idle Mode Off, Sleep Out		Yes										
	Partial Mode On, Idle Mode On, Sleep Out		Yes										
	Sleep In		Yes										
Default	Status		Default Value										
	Power On Sequence		00h										
	SW Reset		00h										
	HW Reset		00h										

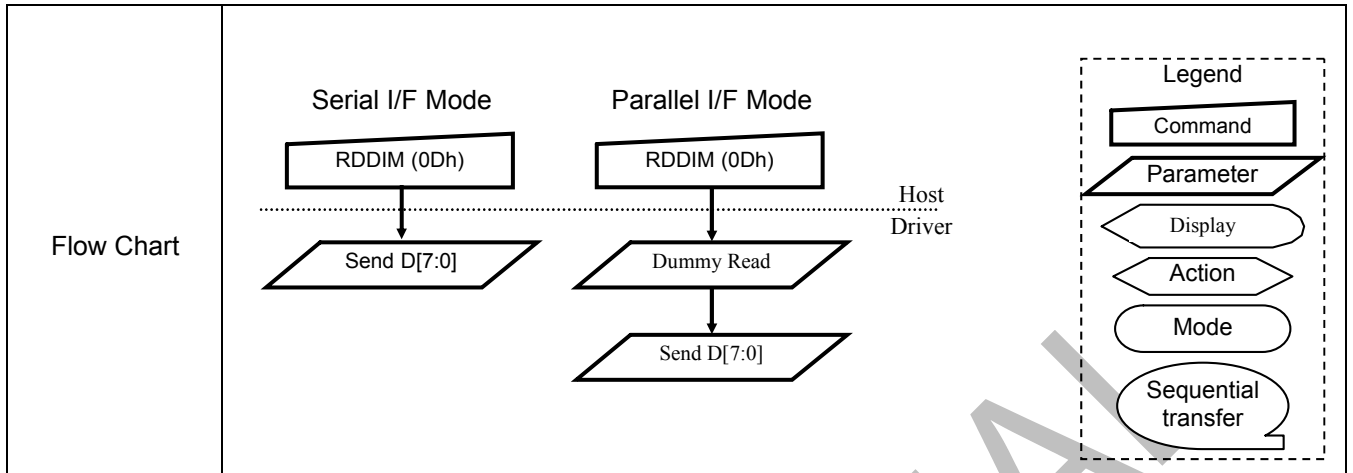

CONFIDENTIAL

RDDSM (0E00h): Read Display Signal Mode

0E00H	RDDSM (Read Display Signal Mode)												
	DCX	RDX	WRX	D15-8	D7	D6	D5	D4	D3	D2	D1	D0	HEX
Command	0	1	↑	x	0	0	0	0	1	1	1	0	0E
1 st parameter	1	↑	1	x	x	x	x	x	x	x	x	x	x
2 nd parameter	1	↑	1	x	D7	D6	D5	D4	D3	D2	D1	D0	00
Description	The display module returns the Display Signal Mode.												
	Bit	Symbol	Description	Comment									
	D7	TEON	Tearing Effect Line On/Off	"1" = On, "0" = Off									
	D6	TELOM	Tearing effect line mode	"0" = mode1, "1" = mode2									
	D5	HS	Horizontal Sync On/Off	'0' = HS bit is 0 '1' = HS bit is 1									
	D4	VS	Vertical Sync On/Off	'0' = VS bit is 0 '1' = VS bit is 1									
	D3	PCLK	Pixel Clock On/Off	'0' = PCLK is Off '1' = PCLK is On									
	D2	DE	Data Enable On/Off	'0' = DE is 0 '1' = DE is 1									
	D1	Reserved		'0'									
	D0	Error on DSI	Error on DSI	'0' = No Error '1' = Error									
Register Availability	Status		Availability										
	Normal Mode On, Idle Mode Off, Sleep Out		Yes										
	Normal Mode On, Idle Mode On, Sleep Out		Yes										
	Partial Mode On, Idle Mode Off, Sleep Out		Yes										
	Partial Mode On, Idle Mode On, Sleep Out		Yes										
	Sleep In		Yes										
Default	Status		Default Value										
	Power On Sequence		00h										
	SW Reset		00h										
	HW Reset		00h										

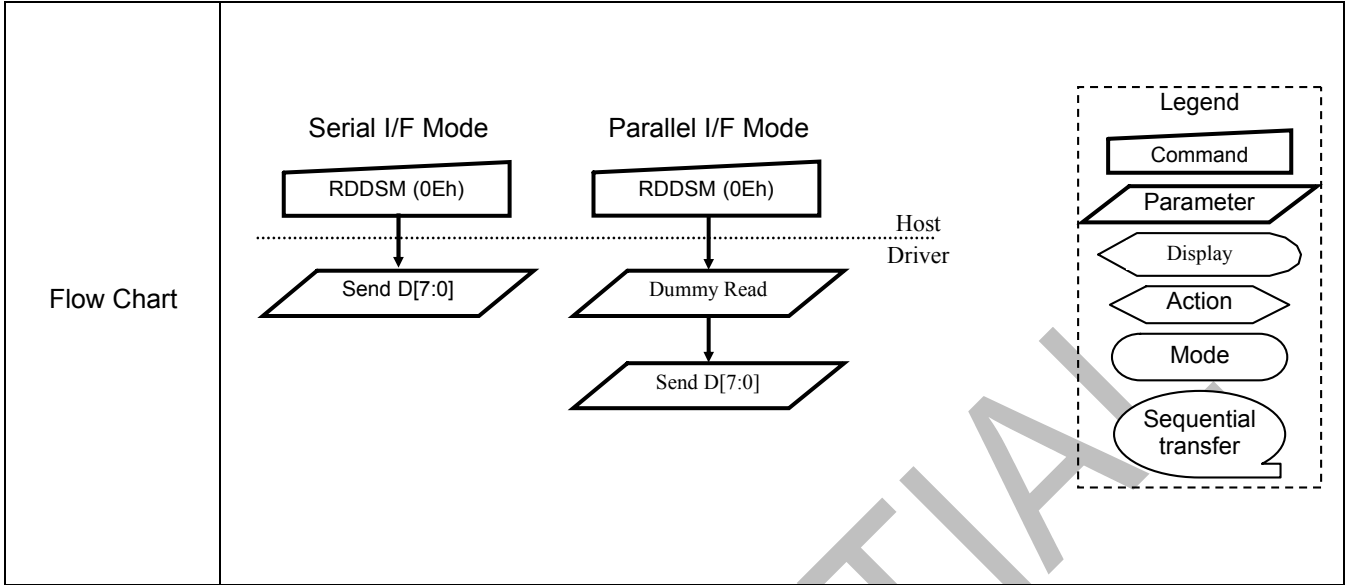

CONFIDENTIAL

RDDSDR (0F00h): Read Display Self-Diagnostic Result

0F00H	RDDSDR (Read Display Self-Diagnostic Result)												HEX
	DCX	RDX	WRX	D15-8	D7	D6	D5	D4	D3	D2	D1	D0	
Command	0	1	↑	x	0	0	0	0	1	1	1	1	0F
1 st Parameter	1	↑	1	x	x	x	x	x	x	x	x	x	x
2 nd Parameter	1	↑	1	x	D7	D6	D5	D4	D3	D2	D1	D0	00
Description	The display module returns the self-diagnostic results following a Sleep Out command.												
	Bit	Symbol	Description		Comment								
	D7	RELD	Register Loading Detection										
	D6	FUND	Functionality Detection										
	D5	CAD	Chip Attachment Detection										
	D4	DGBD	Display Glass Break Detection										
	D3	Reserved			'0'								
	D2	Reserved			'0'								
	D1	Reserved			'0'								
	D0	CSC	Checksums Comparson		'0' = Same '1' = Not Same								
Register Availability	Status		Availability										
	Normal Mode On, Idle Mode Off, Sleep Out		Yes										
	Normal Mode On, Idle Mode On, Sleep Out		Yes										
	Partial Mode On, Idle Mode Off, Sleep Out		Yes										
	Partial Mode On, Idle Mode On, Sleep Out		Yes										
	Sleep In		Yes										
Default	Status		Default Value										
	Power On Sequence		00h										
	SW Reset		00h										
	HW Reset		00h										

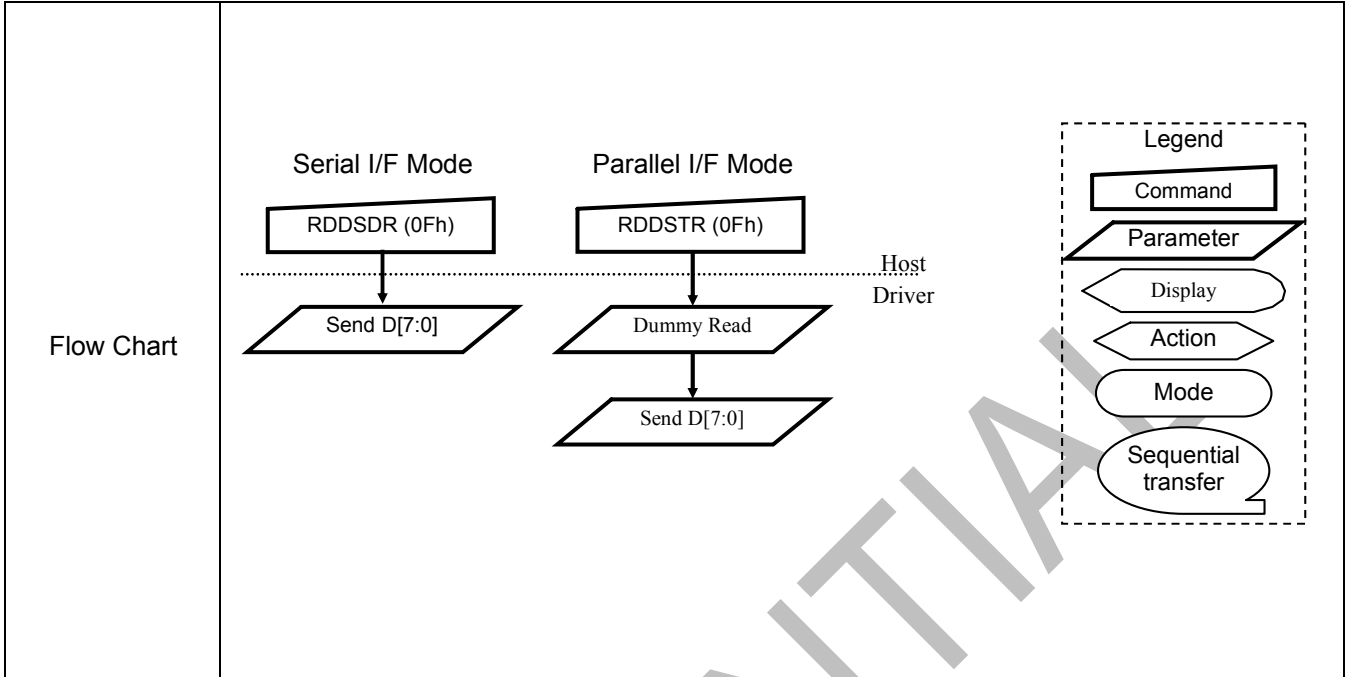

CONFIDENTIAL

SLPIN (1000h): Sleep In

1000H	SLPIN (Sleep In)																								
	DCX	RDX	WRX	D15-8	D7	D6	D5	D4	D3	D2	D1	D0	HEX												
Command	0	1	↑	x	0	0	0	1	0	0	0	0	10												
Parameter	No Parameter																								
Description	<p>This command causes the display module to enter the Sleep mode.</p> <p>This command causes the AMOLED module to enter the Sleep mode. In this mode, the DC/DC converter, internal oscillator and panel scanning stop. DBI or DSI Command Mode remains operational and the frame memory maintains its contents. The host processor continues to send PCLK, HS and VS information to display modules for two frames after this command is sent when the display module is in Normal mode.</p>																								
Restriction	<p>This command has no effect when the display module is already in Sleep mode.</p> <p>The host processor must wait 5 milliseconds before sending any new commands to a display module following this command to allow time for the supply voltages and clock circuits to stabilize. The host processor must wait 120 milliseconds after sending a Sleep Out command before sending an Sleep In command.</p>																								
Register Availability	<table border="1"> <thead> <tr> <th>Status</th> <th>Availability</th> </tr> </thead> <tbody> <tr> <td>Normal Mode On, Idle Mode Off, Sleep Out</td> <td>Yes</td> </tr> <tr> <td>Normal Mode On, Idle Mode On, Sleep Out</td> <td>Yes</td> </tr> <tr> <td>Partial Mode On, Idle Mode Off, Sleep Out</td> <td>Yes</td> </tr> <tr> <td>Partial Mode On, Idle Mode On, Sleep Out</td> <td>Yes</td> </tr> <tr> <td>Sleep In</td> <td>Yes</td> </tr> </tbody> </table>													Status	Availability	Normal Mode On, Idle Mode Off, Sleep Out	Yes	Normal Mode On, Idle Mode On, Sleep Out	Yes	Partial Mode On, Idle Mode Off, Sleep Out	Yes	Partial Mode On, Idle Mode On, Sleep Out	Yes	Sleep In	Yes
Status	Availability																								
Normal Mode On, Idle Mode Off, Sleep Out	Yes																								
Normal Mode On, Idle Mode On, Sleep Out	Yes																								
Partial Mode On, Idle Mode Off, Sleep Out	Yes																								
Partial Mode On, Idle Mode On, Sleep Out	Yes																								
Sleep In	Yes																								
Default	<table border="1"> <thead> <tr> <th>Status</th> <th>Default Value</th> </tr> </thead> <tbody> <tr> <td>Power On Sequence</td> <td>Sleep In Mode</td> </tr> <tr> <td>SW Reset</td> <td>Sleep In Mode</td> </tr> <tr> <td>HW Reset</td> <td>Sleep In Mode</td> </tr> </tbody> </table>													Status	Default Value	Power On Sequence	Sleep In Mode	SW Reset	Sleep In Mode	HW Reset	Sleep In Mode				
Status	Default Value																								
Power On Sequence	Sleep In Mode																								
SW Reset	Sleep In Mode																								
HW Reset	Sleep In Mode																								

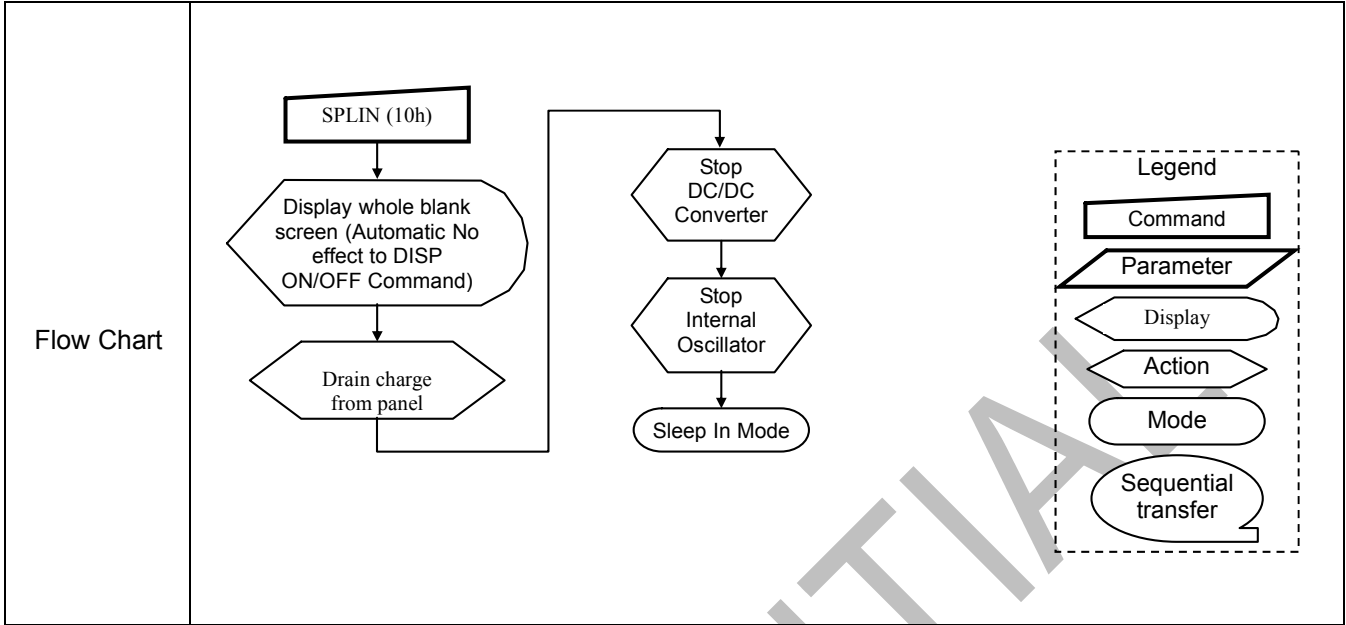

CONFIDENTIAL

SLPOUT (1100h): Sleep Out

1100H	SLPOUT (Sleep Out)																								
	DCX	RDX	WRX	D15-8	D7	D6	D5	D4	D3	D2	D1	D0	HEX												
Command	0	1	↑	x	0	0	0	1	0	0	0	1	11												
Parameter	No Parameter																								
Description	This command causes the display module to exit Sleep mode. All blocks inside the display module are enabled. The host processor sends PCLK, HS and VS information to display modules two frames before this command is sent when the display module is in Normal Mode.																								
Restriction	<p>This command shall not cause any visible effect on the display device when the display module is not in Sleep mode. The host processor must wait five milliseconds after sending this command before sending another command. This delay allows the supply voltages and clock circuits to stabilize.</p> <p>The host processor must wait 120 milliseconds after sending a Sleep Out command before sending a Sleep-In command. The display module loads the display module's default values to the registers when exiting the Sleep mode. There shall not be any abnormal visual effect on the display device when loading the registers if the factory default and register values are the same or when the display module is not in Sleep mode. The display module runs the self-diagnostic functions after this command is received.</p>																								
Register Availability	<table border="1"> <thead> <tr> <th>Status</th> <th>Availability</th> </tr> </thead> <tbody> <tr> <td>Normal Mode On, Idle Mode Off, Sleep Out</td> <td>Yes</td> </tr> <tr> <td>Normal Mode On, Idle Mode On, Sleep Out</td> <td>Yes</td> </tr> <tr> <td>Partial Mode On, Idle Mode Off, Sleep Out</td> <td>Yes</td> </tr> <tr> <td>Partial Mode On, Idle Mode On, Sleep Out</td> <td>Yes</td> </tr> <tr> <td>Sleep In</td> <td>Yes</td> </tr> </tbody> </table>													Status	Availability	Normal Mode On, Idle Mode Off, Sleep Out	Yes	Normal Mode On, Idle Mode On, Sleep Out	Yes	Partial Mode On, Idle Mode Off, Sleep Out	Yes	Partial Mode On, Idle Mode On, Sleep Out	Yes	Sleep In	Yes
Status	Availability																								
Normal Mode On, Idle Mode Off, Sleep Out	Yes																								
Normal Mode On, Idle Mode On, Sleep Out	Yes																								
Partial Mode On, Idle Mode Off, Sleep Out	Yes																								
Partial Mode On, Idle Mode On, Sleep Out	Yes																								
Sleep In	Yes																								
Default	<table border="1"> <thead> <tr> <th>Status</th> <th>Default Value</th> </tr> </thead> <tbody> <tr> <td>Power On Sequence</td> <td>Sleep In Mode</td> </tr> <tr> <td>SW Reset</td> <td>Sleep In Mode</td> </tr> <tr> <td>HW Reset</td> <td>Sleep In Mode</td> </tr> </tbody> </table>													Status	Default Value	Power On Sequence	Sleep In Mode	SW Reset	Sleep In Mode	HW Reset	Sleep In Mode				
Status	Default Value																								
Power On Sequence	Sleep In Mode																								
SW Reset	Sleep In Mode																								
HW Reset	Sleep In Mode																								

Flow chart

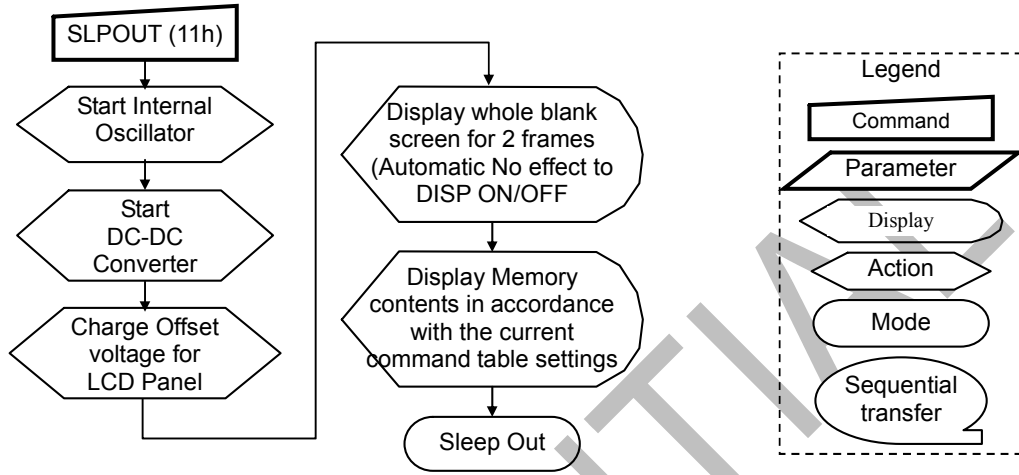

CONFIDENTIAL

PTLON (1200h): Partial Display Mode On

1200H	PTLON (Partial Display Mode On)																								
	DCX	RDX	WRX	D15-8	D7	D6	D5	D4	D3	D2	D1	D0	HEX												
Command	0	1	↑	x	0	0	0	1	0	0	1	0	12												
Parameter	No Parameter																								
Description	<p>This command causes the display module to enter the Partial Display Mode. The Partial Display Mode window is described by the Partial Area (30h) command.</p> <p>To leave Partial Display Mode, the Normal Display Mode On (13h) command should be written. The host processor continues to send PCLK, HS and VS information to display modules for two frames after this command is sent when the display module is in Normal Display Mode.</p>																								
Restriction	This command has no effect when Partial Display Mode is already active.																								
Register Availability	<table border="1"> <thead> <tr> <th>Status</th> <th>Availability</th> </tr> </thead> <tbody> <tr> <td>Normal Mode On, Idle Mode Off, Sleep Out</td> <td>Yes</td> </tr> <tr> <td>Normal Mode On, Idle Mode On, Sleep Out</td> <td>Yes</td> </tr> <tr> <td>Partial Mode On, Idle Mode Off, Sleep Out</td> <td>Yes</td> </tr> <tr> <td>Partial Mode On, Idle Mode On, Sleep Out</td> <td>Yes</td> </tr> <tr> <td>Sleep In</td> <td>Yes</td> </tr> </tbody> </table>													Status	Availability	Normal Mode On, Idle Mode Off, Sleep Out	Yes	Normal Mode On, Idle Mode On, Sleep Out	Yes	Partial Mode On, Idle Mode Off, Sleep Out	Yes	Partial Mode On, Idle Mode On, Sleep Out	Yes	Sleep In	Yes
Status	Availability																								
Normal Mode On, Idle Mode Off, Sleep Out	Yes																								
Normal Mode On, Idle Mode On, Sleep Out	Yes																								
Partial Mode On, Idle Mode Off, Sleep Out	Yes																								
Partial Mode On, Idle Mode On, Sleep Out	Yes																								
Sleep In	Yes																								
Default	<table border="1"> <thead> <tr> <th>Status</th> <th>Default Value</th> </tr> </thead> <tbody> <tr> <td>Power On Sequence</td> <td>Normal display mode On</td> </tr> <tr> <td>SW Reset</td> <td>Normal display mode On</td> </tr> <tr> <td>HW Reset</td> <td>Normal display mode On</td> </tr> </tbody> </table>													Status	Default Value	Power On Sequence	Normal display mode On	SW Reset	Normal display mode On	HW Reset	Normal display mode On				
Status	Default Value																								
Power On Sequence	Normal display mode On																								
SW Reset	Normal display mode On																								
HW Reset	Normal display mode On																								
Flow Chart	Refer to Partial Area (30h)																								

NORON (1300h): Normal Display Mode On

1300H	NORON (Normal Display Mode On)																								
	DCX	RDX	WRX	D15-8	D7	D6	D5	D4	D3	D2	D1	D0	HEX												
Command	0	1	↑	x	0	0	0	1	0	0	1	1	13												
Parameter	No Parameter																								
Description	<p>This command causes the display module to enter the Normal mode. Normal Mode is defined as Partial Display mode and Scroll mode are off.</p> <p>The host processor sends PCLK, HS and VS information to Type 2 display modules two frames before this command is sent when the display module is in Partial Display Mode.</p>																								
Restriction	This command has no effect when Normal Display mode is already active.																								
Register Availability	<table border="1"> <thead> <tr> <th>Status</th> <th>Availability</th> </tr> </thead> <tbody> <tr> <td>Normal Mode On, Idle Mode Off, Sleep Out</td> <td>Yes</td> </tr> <tr> <td>Normal Mode On, Idle Mode On, Sleep Out</td> <td>Yes</td> </tr> <tr> <td>Partial Mode On, Idle Mode Off, Sleep Out</td> <td>Yes</td> </tr> <tr> <td>Partial Mode On, Idle Mode On, Sleep Out</td> <td>Yes</td> </tr> <tr> <td>Sleep In</td> <td>Yes</td> </tr> </tbody> </table>													Status	Availability	Normal Mode On, Idle Mode Off, Sleep Out	Yes	Normal Mode On, Idle Mode On, Sleep Out	Yes	Partial Mode On, Idle Mode Off, Sleep Out	Yes	Partial Mode On, Idle Mode On, Sleep Out	Yes	Sleep In	Yes
Status	Availability																								
Normal Mode On, Idle Mode Off, Sleep Out	Yes																								
Normal Mode On, Idle Mode On, Sleep Out	Yes																								
Partial Mode On, Idle Mode Off, Sleep Out	Yes																								
Partial Mode On, Idle Mode On, Sleep Out	Yes																								
Sleep In	Yes																								
Default	<table border="1"> <thead> <tr> <th>Status</th> <th>Default Value</th> </tr> </thead> <tbody> <tr> <td>Power On Sequence</td> <td>Normal Display Mode On</td> </tr> <tr> <td>SW Reset</td> <td>Normal Display Mode On</td> </tr> <tr> <td>HW Reset</td> <td>Normal Display Mode On</td> </tr> </tbody> </table>													Status	Default Value	Power On Sequence	Normal Display Mode On	SW Reset	Normal Display Mode On	HW Reset	Normal Display Mode On				
Status	Default Value																								
Power On Sequence	Normal Display Mode On																								
SW Reset	Normal Display Mode On																								
HW Reset	Normal Display Mode On																								
Flow Chart	Refer to the description of Partial Area (3000h)																								

INVOFF (2000H): Display Inversion Off

2000H	INVOFF (Display Inversion Off)																								
	DCX	RDX	WRX	D15-8	D7	D6	D5	D4	D3	D2	D1	D0	HEX												
Command	0	1	↑	x	0	0	1	0	0	0	0	0	20												
Parameter	No Parameter																								
Description	<p>This command causes the display module to stop inverting the image data on the display device. The frame memory contents remain unchanged. No status bits are changed.</p> <div style="display: flex; justify-content: space-around; align-items: center;"> <div style="text-align: center;"> <p>Memory</p> </div> <div style="font-size: 2em; margin: 0 20px;">→</div> <div style="text-align: center;"> <p>Display Panel</p> </div> </div>																								
Restriction	This command has no effect when the display module is not inverting the display image.																								
Register Availability	<table border="1" style="width: 100%; border-collapse: collapse;"> <thead> <tr> <th>Status</th> <th>Availability</th> </tr> </thead> <tbody> <tr> <td>Normal Mode On, Idle Mode Off, Sleep Out</td> <td>Yes</td> </tr> <tr> <td>Normal Mode On, Idle Mode On, Sleep Out</td> <td>Yes</td> </tr> <tr> <td>Partial Mode On, Idle Mode Off, Sleep Out</td> <td>Yes</td> </tr> <tr> <td>Partial Mode On, Idle Mode On, Sleep Out</td> <td>Yes</td> </tr> <tr> <td>Sleep In</td> <td>Yes</td> </tr> </tbody> </table>													Status	Availability	Normal Mode On, Idle Mode Off, Sleep Out	Yes	Normal Mode On, Idle Mode On, Sleep Out	Yes	Partial Mode On, Idle Mode Off, Sleep Out	Yes	Partial Mode On, Idle Mode On, Sleep Out	Yes	Sleep In	Yes
Status	Availability																								
Normal Mode On, Idle Mode Off, Sleep Out	Yes																								
Normal Mode On, Idle Mode On, Sleep Out	Yes																								
Partial Mode On, Idle Mode Off, Sleep Out	Yes																								
Partial Mode On, Idle Mode On, Sleep Out	Yes																								
Sleep In	Yes																								
Default	<table border="1" style="width: 100%; border-collapse: collapse;"> <thead> <tr> <th>Status</th> <th>Default Value</th> </tr> </thead> <tbody> <tr> <td>Power On Sequence</td> <td>Display Inversion off</td> </tr> <tr> <td>SW Reset</td> <td>Display Inversion off</td> </tr> <tr> <td>HW Reset</td> <td>Display Inversion off</td> </tr> </tbody> </table>													Status	Default Value	Power On Sequence	Display Inversion off	SW Reset	Display Inversion off	HW Reset	Display Inversion off				
Status	Default Value																								
Power On Sequence	Display Inversion off																								
SW Reset	Display Inversion off																								
HW Reset	Display Inversion off																								

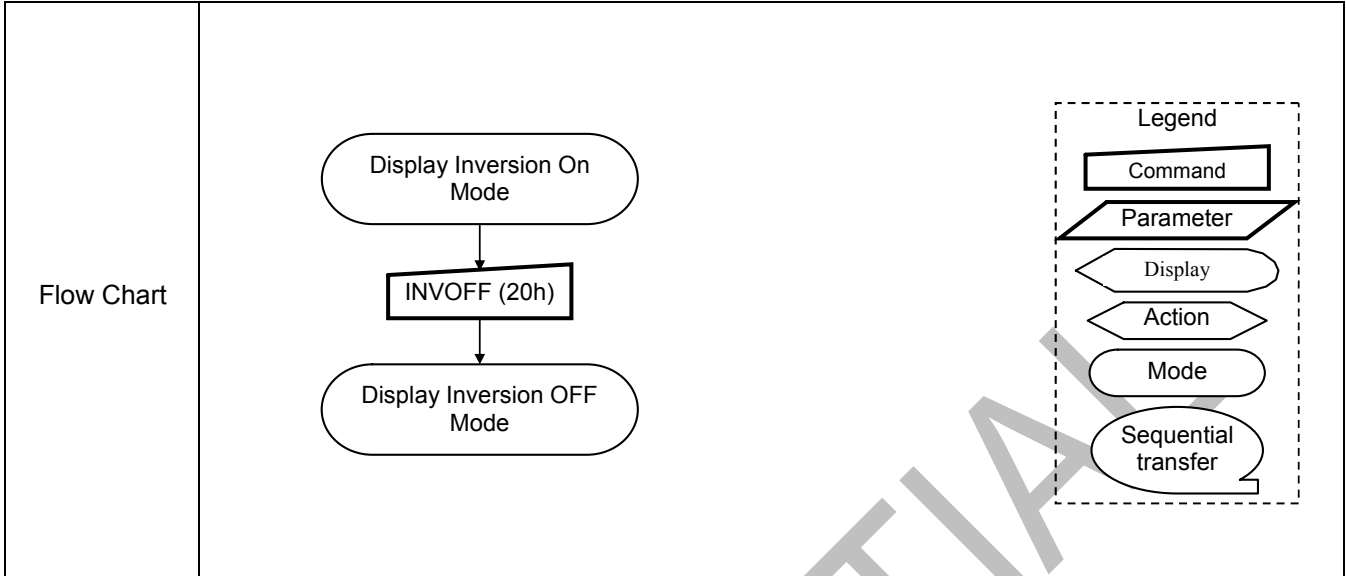

CONFIDENTIAL

INVON (2100H): Display Inversion On

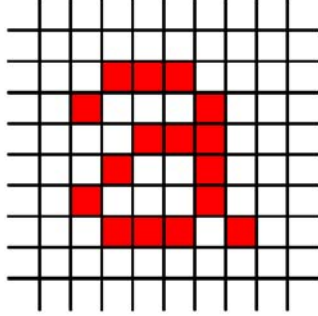
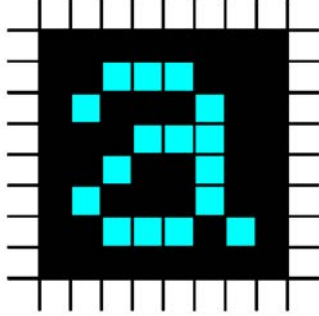
2100H	INVON (Display Inversion On)																								
	DCX	RDX	WRX	D15-8	D7	D6	D5	D4	D3	D2	D1	D0	HEX												
Command	0	1	↑	x	0	0	1	0	0	0	0	1	21												
Parameter	No Parameter																								
Description	<p>This command causes the display module to invert the image data only on the display device. The frame memory contents remain unchanged. No status bits are changed.</p> <div style="display: flex; justify-content: space-around; align-items: center;"> <div style="text-align: center;"> <p>Memory</p>  </div> <div style="font-size: 2em; margin: 0 20px;">→</div> <div style="text-align: center;"> <p>Display Panel</p>  </div> </div>																								
Restriction	This command has no effect when module is already in inversion on mode.																								
Register Availability	<table border="1" style="width: 100%; border-collapse: collapse;"> <thead> <tr> <th>Status</th> <th>Availability</th> </tr> </thead> <tbody> <tr> <td>Normal Mode On, Idle Mode Off, Sleep Out</td> <td>Yes</td> </tr> <tr> <td>Normal Mode On, Idle Mode On, Sleep Out</td> <td>Yes</td> </tr> <tr> <td>Partial Mode On, Idle Mode Off, Sleep Out</td> <td>Yes</td> </tr> <tr> <td>Partial Mode On, Idle Mode On, Sleep Out</td> <td>Yes</td> </tr> <tr> <td>Sleep In</td> <td>Yes</td> </tr> </tbody> </table>													Status	Availability	Normal Mode On, Idle Mode Off, Sleep Out	Yes	Normal Mode On, Idle Mode On, Sleep Out	Yes	Partial Mode On, Idle Mode Off, Sleep Out	Yes	Partial Mode On, Idle Mode On, Sleep Out	Yes	Sleep In	Yes
Status	Availability																								
Normal Mode On, Idle Mode Off, Sleep Out	Yes																								
Normal Mode On, Idle Mode On, Sleep Out	Yes																								
Partial Mode On, Idle Mode Off, Sleep Out	Yes																								
Partial Mode On, Idle Mode On, Sleep Out	Yes																								
Sleep In	Yes																								
Default	<table border="1" style="width: 100%; border-collapse: collapse;"> <thead> <tr> <th>Status</th> <th>Default Value</th> </tr> </thead> <tbody> <tr> <td>Power On Sequence</td> <td>Display Inversion off</td> </tr> <tr> <td>SW Reset</td> <td>Display Inversion off</td> </tr> <tr> <td>HW Reset</td> <td>Display Inversion off</td> </tr> </tbody> </table>													Status	Default Value	Power On Sequence	Display Inversion off	SW Reset	Display Inversion off	HW Reset	Display Inversion off				
Status	Default Value																								
Power On Sequence	Display Inversion off																								
SW Reset	Display Inversion off																								
HW Reset	Display Inversion off																								

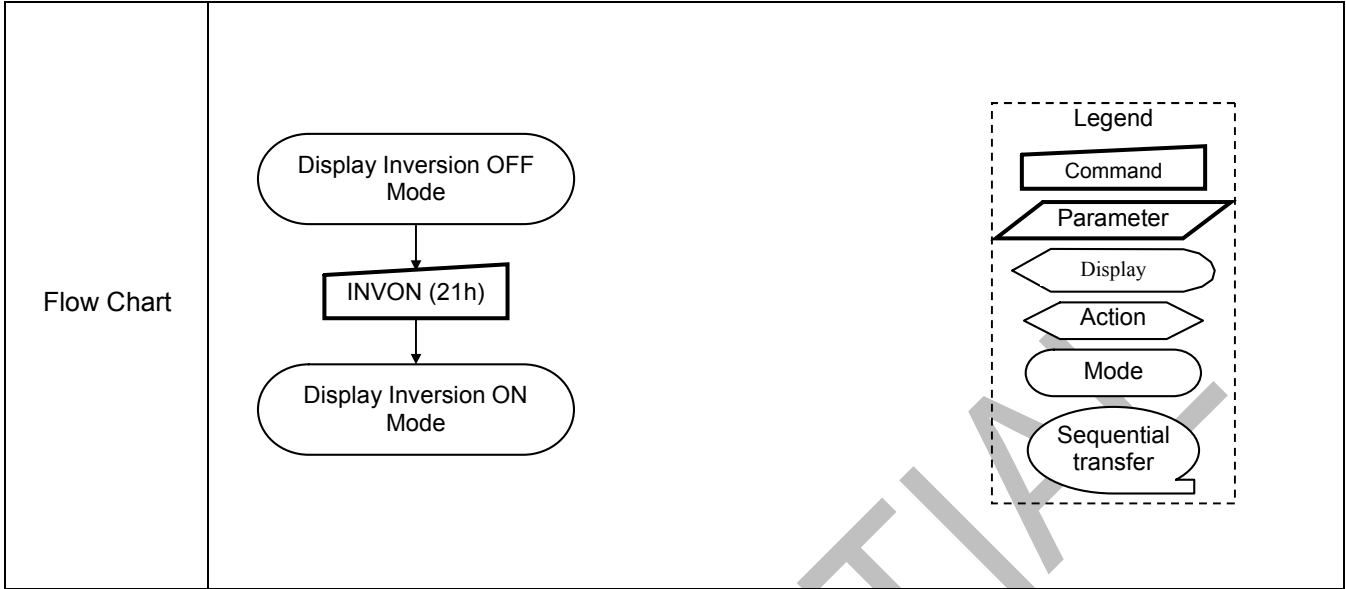

CONFIDENTIAL

ALLPOFF (2200H): All Pixel Off

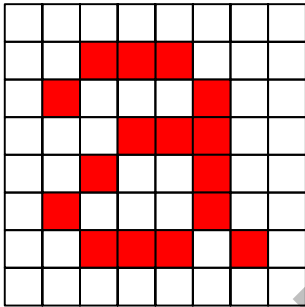
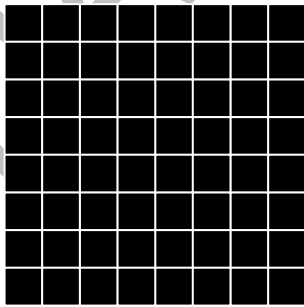
2200H	ALLPOFF																								
	DCX	RDX	WRX	D15-8	D7	D6	D5	D4	D3	D2	D1	D0	HEX												
Command	0	1	↑	x	0	0	1	0	0	0	1	0	22												
Parameter	No Parameter																								
Description	<p>This command turns the display panel black in Sleep Out mode and a status of the Display On/Off register can be on or off.</p> <p>This command makes no change of contents of frame memory.</p> <p>This command does not change any other status.</p> <div style="display: flex; justify-content: space-around; align-items: center;"> <div style="text-align: center;"> <p>Memory</p>  </div> <div style="font-size: 2em;">→</div> <div style="text-align: center;"> <p>Display</p>  </div> </div> <p>“All Pixels On”, “Normal Display Mode On” or “Partial Mode On” commands are used to leave this mode. The display panel is showing the content of the frame memory after “Normal Display On” and “Partial Mode On” commands.</p>																								
Restriction	-																								
Register Availability	<table border="1" style="width: 100%; border-collapse: collapse;"> <thead> <tr> <th style="width: 70%;">Status</th> <th style="width: 30%;">Availability</th> </tr> </thead> <tbody> <tr> <td>Normal Mode On, Idle Mode Off, Sleep Out</td> <td style="text-align: center;">Yes</td> </tr> <tr> <td>Normal Mode On, Idle Mode On, Sleep Out</td> <td style="text-align: center;">Yes</td> </tr> <tr> <td>Partial Mode On, Idle Mode Off, Sleep Out</td> <td style="text-align: center;">Yes</td> </tr> <tr> <td>Partial Mode On, Idle Mode On, Sleep Out</td> <td style="text-align: center;">Yes</td> </tr> <tr> <td style="text-align: center;">Sleep In</td> <td style="text-align: center;">Yes</td> </tr> </tbody> </table>													Status	Availability	Normal Mode On, Idle Mode Off, Sleep Out	Yes	Normal Mode On, Idle Mode On, Sleep Out	Yes	Partial Mode On, Idle Mode Off, Sleep Out	Yes	Partial Mode On, Idle Mode On, Sleep Out	Yes	Sleep In	Yes
Status	Availability																								
Normal Mode On, Idle Mode Off, Sleep Out	Yes																								
Normal Mode On, Idle Mode On, Sleep Out	Yes																								
Partial Mode On, Idle Mode Off, Sleep Out	Yes																								
Partial Mode On, Idle Mode On, Sleep Out	Yes																								
Sleep In	Yes																								
Default	<table border="1" style="width: 100%; border-collapse: collapse;"> <thead> <tr> <th style="width: 50%;">Status</th> <th style="width: 50%;">Default Value</th> </tr> </thead> <tbody> <tr> <td>Power On Sequence</td> <td style="text-align: center;">Display Inversion off</td> </tr> <tr> <td>SW Reset</td> <td style="text-align: center;">Display Inversion off</td> </tr> <tr> <td>HW Reset</td> <td style="text-align: center;">Display Inversion off</td> </tr> </tbody> </table>													Status	Default Value	Power On Sequence	Display Inversion off	SW Reset	Display Inversion off	HW Reset	Display Inversion off				
Status	Default Value																								
Power On Sequence	Display Inversion off																								
SW Reset	Display Inversion off																								
HW Reset	Display Inversion off																								

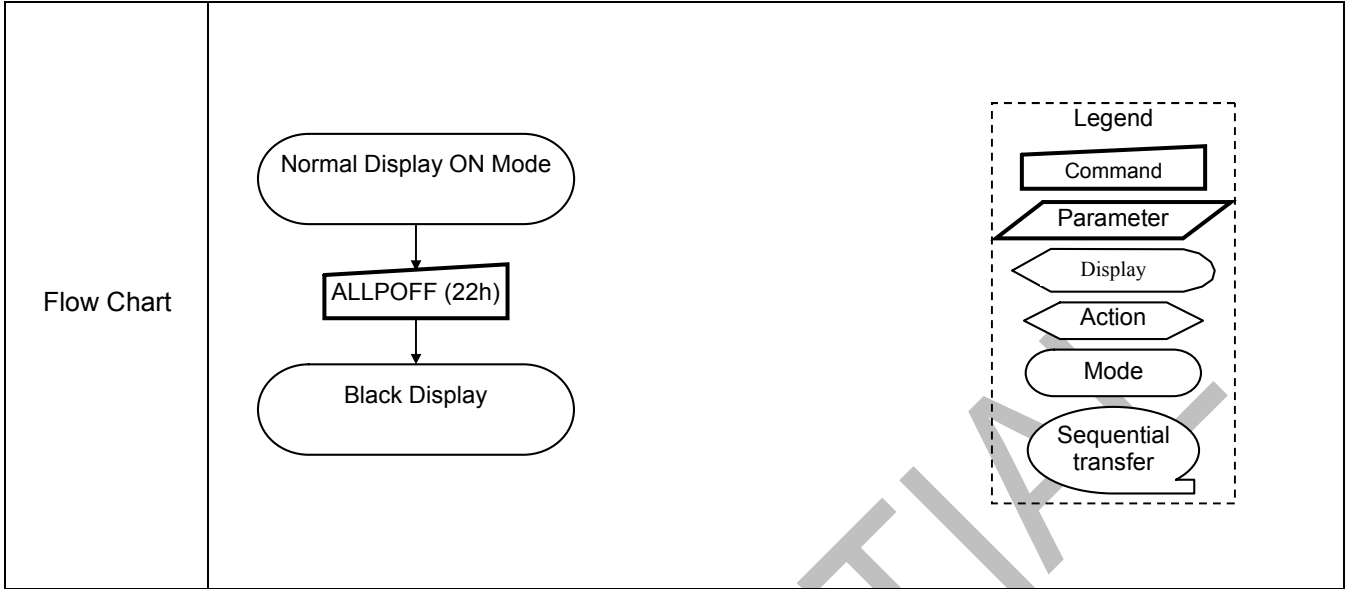

CONFIDENTIAL

ALLPON (2300H): All Pixel On

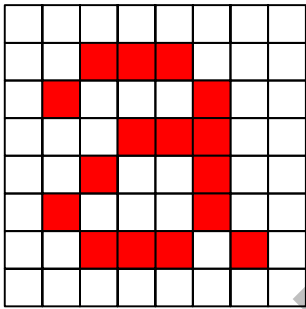
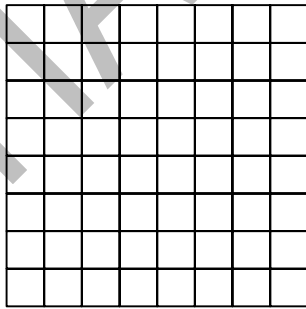
2300H	ALLPON																								
	DCX	RDX	WRX	D15-8	D7	D6	D5	D4	D3	D2	D1	D0	HEX												
Command	0	1	↑	x	0	0	1	0	0	0	1	1	23												
Parameter	No Parameter																								
Description	<p>This command turns the display panel white in Sleep Out mode and a status of the Display On/Off register can be on or off.</p> <p>This command makes no change of contents of frame memory.</p> <p>This command does not change any other status.</p> <div style="display: flex; justify-content: space-around; align-items: center;"> <div style="text-align: center;"> <p>Memory</p>  </div> <div style="font-size: 2em;">→</div> <div style="text-align: center;"> <p>Display</p>  </div> </div> <p>“All Pixels Off”, “Normal Display Mode On” or “Partial Mode On” commands are used to leave this mode. The display panel is showing the content of the frame memory after “Normal Display On” and “Partial Mode On” commands.</p>																								
Restriction	-																								
Register Availability	<table border="1" style="width: 100%; border-collapse: collapse;"> <thead> <tr> <th>Status</th> <th>Availability</th> </tr> </thead> <tbody> <tr> <td>Normal Mode On, Idle Mode Off, Sleep Out</td> <td>Yes</td> </tr> <tr> <td>Normal Mode On, Idle Mode On, Sleep Out</td> <td>Yes</td> </tr> <tr> <td>Partial Mode On, Idle Mode Off, Sleep Out</td> <td>Yes</td> </tr> <tr> <td>Partial Mode On, Idle Mode On, Sleep Out</td> <td>Yes</td> </tr> <tr> <td>Sleep In</td> <td>Yes</td> </tr> </tbody> </table>													Status	Availability	Normal Mode On, Idle Mode Off, Sleep Out	Yes	Normal Mode On, Idle Mode On, Sleep Out	Yes	Partial Mode On, Idle Mode Off, Sleep Out	Yes	Partial Mode On, Idle Mode On, Sleep Out	Yes	Sleep In	Yes
Status	Availability																								
Normal Mode On, Idle Mode Off, Sleep Out	Yes																								
Normal Mode On, Idle Mode On, Sleep Out	Yes																								
Partial Mode On, Idle Mode Off, Sleep Out	Yes																								
Partial Mode On, Idle Mode On, Sleep Out	Yes																								
Sleep In	Yes																								
Default	<table border="1" style="width: 100%; border-collapse: collapse;"> <thead> <tr> <th>Status</th> <th>Default Value</th> </tr> </thead> <tbody> <tr> <td>Power On Sequence</td> <td>Display Inversion off</td> </tr> <tr> <td>SW Reset</td> <td>Display Inversion off</td> </tr> <tr> <td>HW Reset</td> <td>Display Inversion off</td> </tr> </tbody> </table>													Status	Default Value	Power On Sequence	Display Inversion off	SW Reset	Display Inversion off	HW Reset	Display Inversion off				
Status	Default Value																								
Power On Sequence	Display Inversion off																								
SW Reset	Display Inversion off																								
HW Reset	Display Inversion off																								

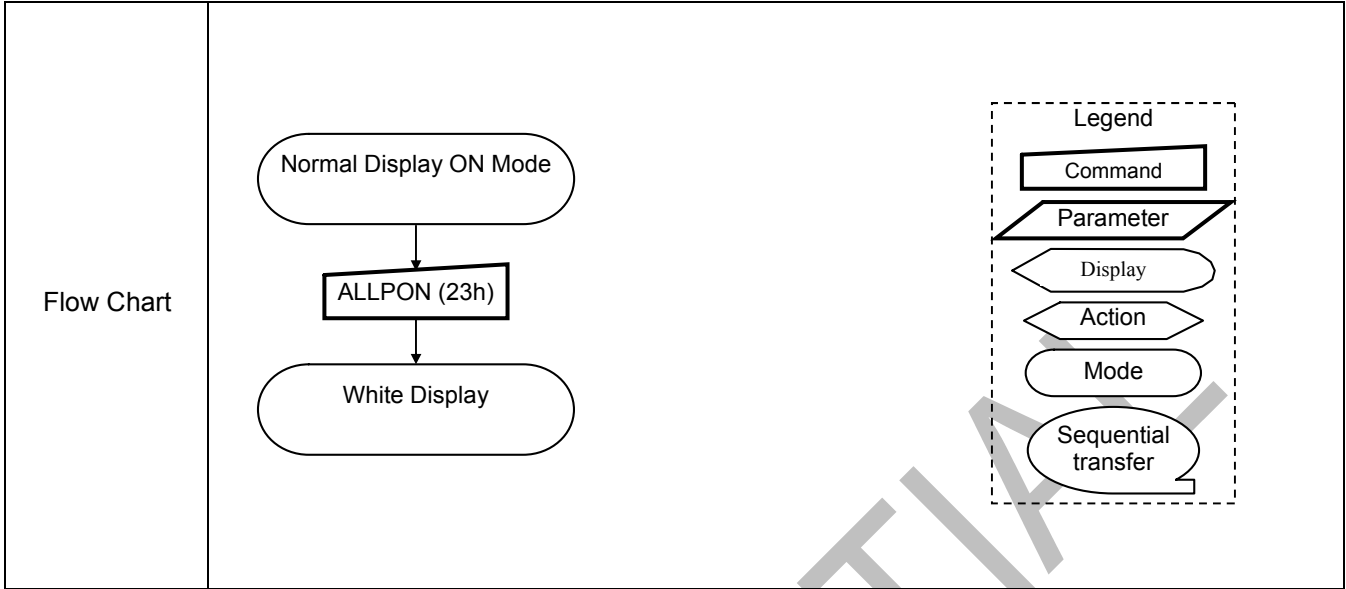

CONFIDENTIAL

GAMSET (2600H): Gamma Set

2600H	GAMSET												
	DCX	RDX	WRX	D15-8	D7	D6	D5	D4	D3	D2	D1	D0	HEX
Command	0	1	↑	x	0	0	1	0	0	1	1	0	26
1 st parameter	1	1	↑	x	GC7	GC6	GC5	GC4	GC3	GC2	GC1	GC0	01
Parameter	No Parameter												
Description	This command is used to select the desired Gamma curve for the current display. A maximum of 4 curves can be selected. The curve is selected by setting the appropriate bit in the parameter as described in the Table.												
	GC[7:0]				Parameter				Curve				
	01h				GC0				Gamma Curve (G2.2)				
	02h				GC1				Reserved				
	04h				GC2				Reserved				
08h				GC3				Reserved					
Note: All other values are undefined.													
Restriction	Values of GC [7:0] not shown in table above are invalid and will not change the current selected gamma												
Register Availability	Status						Availability						
	Normal Mode On, Idle Mode Off, Sleep Out						Yes						
	Normal Mode On, Idle Mode On, Sleep Out						Yes						
	Partial Mode On, Idle Mode Off, Sleep Out						Yes						
	Partial Mode On, Idle Mode On, Sleep Out						Yes						
	Sleep In						Yes						
Default	Status					Default Value							
	Power On Sequence					01h							
	SW Reset					01h							
	HW Reset					01h							

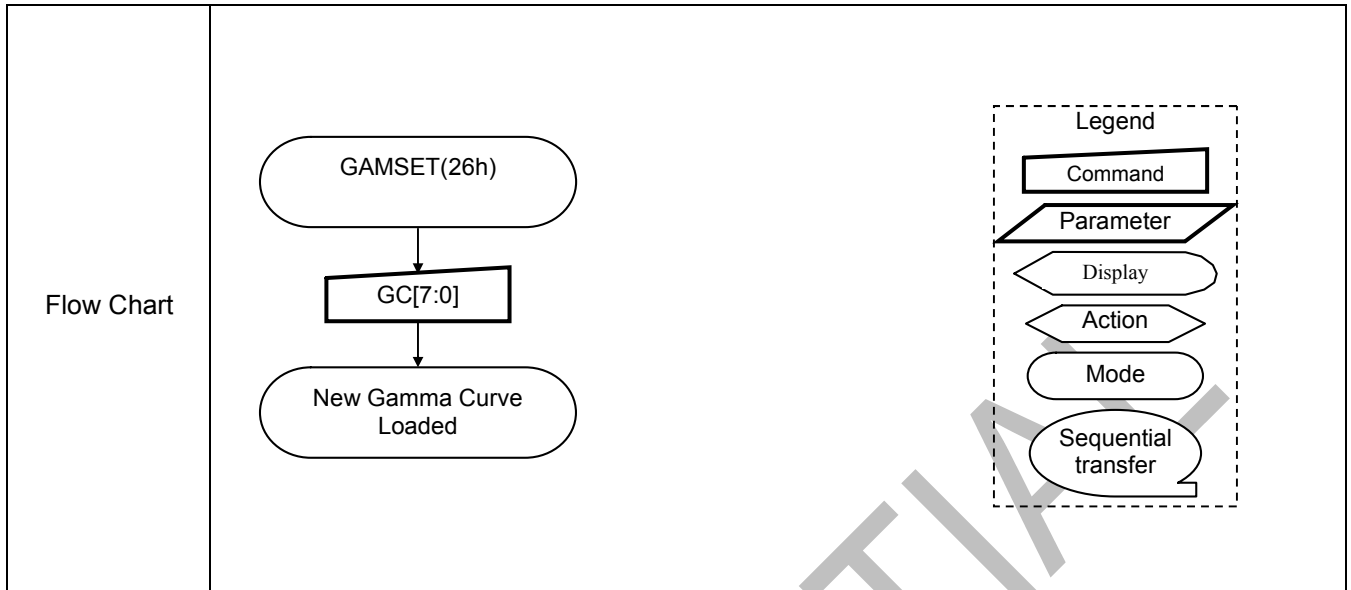

CONFIDENTIAL

DISPOFF (2800h): Display Off

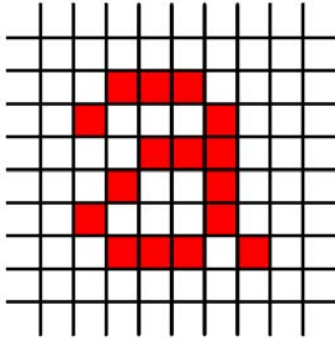
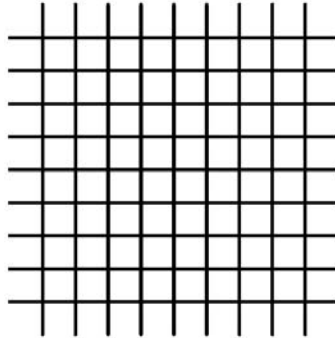
2800H	DISPOFF (Display Off)												HEX												
	DCX	RDX	WRX	D15-8	D7	D6	D5	D4	D3	D2	D1	D0													
Command	0	1	↑	x	0	0	1	0	1	0	0	0	28												
Parameter	No Parameter																								
Description	<p>This command causes the display module to stop displaying the image data on the display device. The frame memory contents remain unchanged. No status bits are changed.</p> <div style="display: flex; justify-content: space-around; align-items: center;"> <div style="text-align: center;"> <p>Memory</p>  </div> <div style="font-size: 2em; margin: 0 20px;">→</div> <div style="text-align: center;"> <p>Display Panel</p>  </div> </div>																								
Restriction	This command has no effect when module is already in display off mode.																								
Register Availability	<table border="1" style="width: 100%; border-collapse: collapse;"> <thead> <tr> <th>Status</th> <th>Availability</th> </tr> </thead> <tbody> <tr> <td>Normal Mode On, Idle Mode Off, Sleep Out</td> <td>Yes</td> </tr> <tr> <td>Normal Mode On, Idle Mode On, Sleep Out</td> <td>Yes</td> </tr> <tr> <td>Partial Mode On, Idle Mode Off, Sleep Out</td> <td>Yes</td> </tr> <tr> <td>Partial Mode On, Idle Mode On, Sleep Out</td> <td>Yes</td> </tr> <tr> <td>Sleep In</td> <td>Yes</td> </tr> </tbody> </table>													Status	Availability	Normal Mode On, Idle Mode Off, Sleep Out	Yes	Normal Mode On, Idle Mode On, Sleep Out	Yes	Partial Mode On, Idle Mode Off, Sleep Out	Yes	Partial Mode On, Idle Mode On, Sleep Out	Yes	Sleep In	Yes
Status	Availability																								
Normal Mode On, Idle Mode Off, Sleep Out	Yes																								
Normal Mode On, Idle Mode On, Sleep Out	Yes																								
Partial Mode On, Idle Mode Off, Sleep Out	Yes																								
Partial Mode On, Idle Mode On, Sleep Out	Yes																								
Sleep In	Yes																								
Default	<table border="1" style="width: 100%; border-collapse: collapse;"> <thead> <tr> <th>Status</th> <th>Default Value</th> </tr> </thead> <tbody> <tr> <td>Power On Sequence</td> <td>Display Off</td> </tr> <tr> <td>SW Reset</td> <td>Display Off</td> </tr> <tr> <td>HW Reset</td> <td>Display Off</td> </tr> </tbody> </table>													Status	Default Value	Power On Sequence	Display Off	SW Reset	Display Off	HW Reset	Display Off				
Status	Default Value																								
Power On Sequence	Display Off																								
SW Reset	Display Off																								
HW Reset	Display Off																								

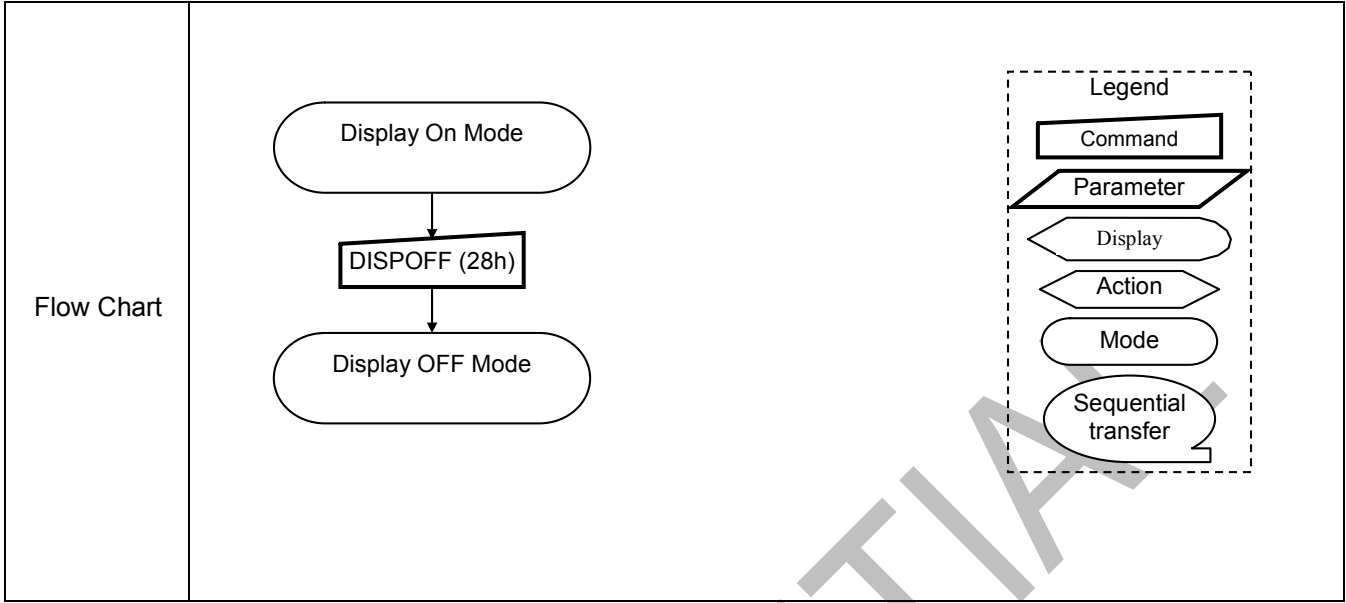

CONFIDENTIAL

DISPON (2900h): Display On

2900H	DISPON (Display On)																								
	DCX	RDX	WRX	D15-8	D7	D6	D5	D4	D3	D2	D1	D0	HEX												
Command	0	1	↑	x	0	0	1	0	1	0	0	1	29												
Parameter	No Parameter																								
Description	<p>This command causes the display module to start displaying the image data on the display device. The frame memory contents remain unchanged. No status bits are changed.</p> <div style="display: flex; justify-content: space-around; align-items: center;"> <div style="text-align: center;"> <p>Memory</p> </div> <div style="font-size: 2em; margin: 0 20px;">→</div> <div style="text-align: center;"> <p>Display Panel</p> </div> </div>																								
Restriction	This command has no effect when module is already in display on mode.																								
Register Availability	<table border="1" style="width: 100%; border-collapse: collapse;"> <thead> <tr> <th style="width: 80%;">Status</th> <th style="width: 20%;">Availability</th> </tr> </thead> <tbody> <tr> <td>Normal Mode On, Idle Mode Off, Sleep Out</td> <td style="text-align: center;">Yes</td> </tr> <tr> <td>Normal Mode On, Idle Mode On, Sleep Out</td> <td style="text-align: center;">Yes</td> </tr> <tr> <td>Partial Mode On, Idle Mode Off, Sleep Out</td> <td style="text-align: center;">Yes</td> </tr> <tr> <td>Partial Mode On, Idle Mode On, Sleep Out</td> <td style="text-align: center;">Yes</td> </tr> <tr> <td style="text-align: center;">Sleep In</td> <td style="text-align: center;">Yes</td> </tr> </tbody> </table>													Status	Availability	Normal Mode On, Idle Mode Off, Sleep Out	Yes	Normal Mode On, Idle Mode On, Sleep Out	Yes	Partial Mode On, Idle Mode Off, Sleep Out	Yes	Partial Mode On, Idle Mode On, Sleep Out	Yes	Sleep In	Yes
Status	Availability																								
Normal Mode On, Idle Mode Off, Sleep Out	Yes																								
Normal Mode On, Idle Mode On, Sleep Out	Yes																								
Partial Mode On, Idle Mode Off, Sleep Out	Yes																								
Partial Mode On, Idle Mode On, Sleep Out	Yes																								
Sleep In	Yes																								
Default	<table border="1" style="width: 100%; border-collapse: collapse;"> <thead> <tr> <th style="width: 50%;">Status</th> <th style="width: 50%;">Default Value</th> </tr> </thead> <tbody> <tr> <td>Power On Sequence</td> <td style="text-align: center;">Display Off</td> </tr> <tr> <td>SW Reset</td> <td style="text-align: center;">Display Off</td> </tr> <tr> <td>HW Reset</td> <td style="text-align: center;">Display Off</td> </tr> </tbody> </table>													Status	Default Value	Power On Sequence	Display Off	SW Reset	Display Off	HW Reset	Display Off				
Status	Default Value																								
Power On Sequence	Display Off																								
SW Reset	Display Off																								
HW Reset	Display Off																								

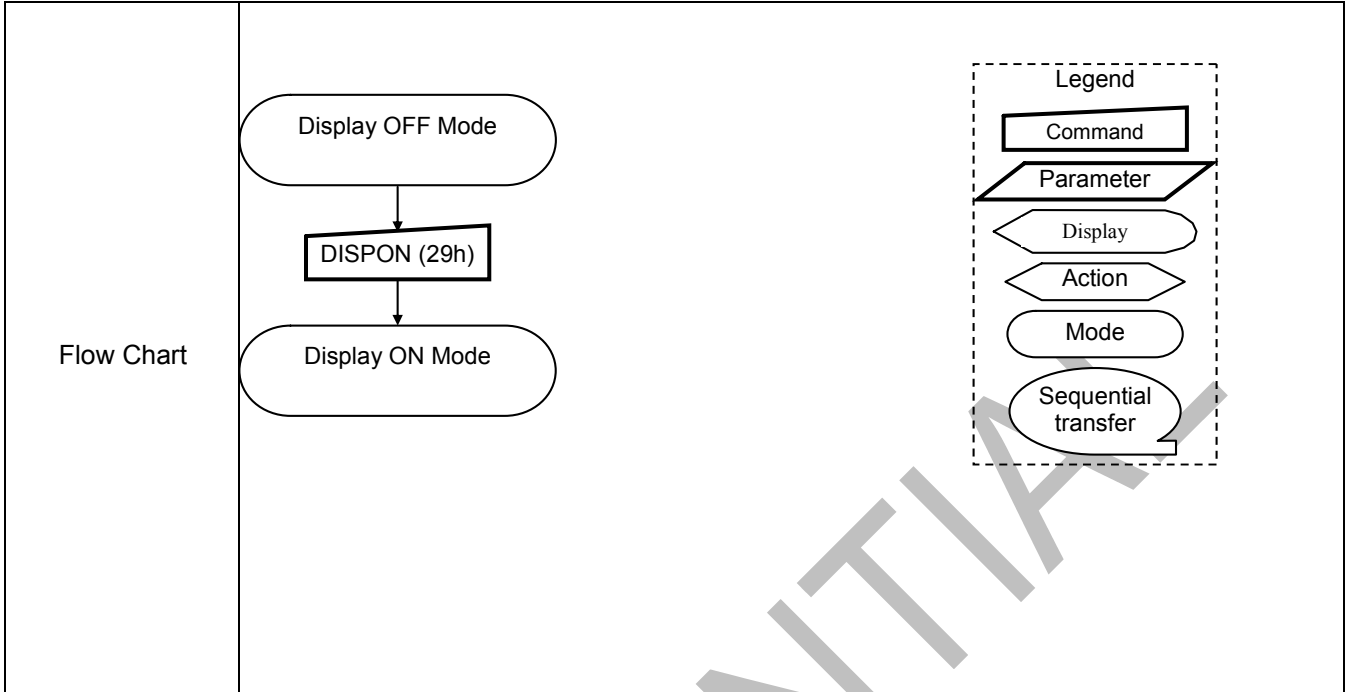

CONFIDENTIAL

CASET (2A00h): Column Address Set

2A00H	CASET (Column Address Set)												HEX
	DCX	RDX	WRX	D15-8	D7	D6	D5	D4	D3	D2	D1	D0	
Command	0	1	↑	x	0	0	1	0	1	0	1	0	2A
1 st parameter	1	1	↑	x	0	0	0	0	0	0	0	0	SC8 00
2 nd parameter	1	1	↑	x	SC7	SC6	SC5	SC4	SC3	SC2	SC1	SC0	00
3 rd parameter	1	1	↑	x	0	0	0	0	0	0	0	0	EC8 01
4 th parameter	1	1	↑	x	EC7	EC6	EC5	EC4	EC3	EC2	EC1	EC0	DF

This command defines the column extent of the frame memory accessed by the host processor with the read_memory_continue and write_memory_continue commands.

Description

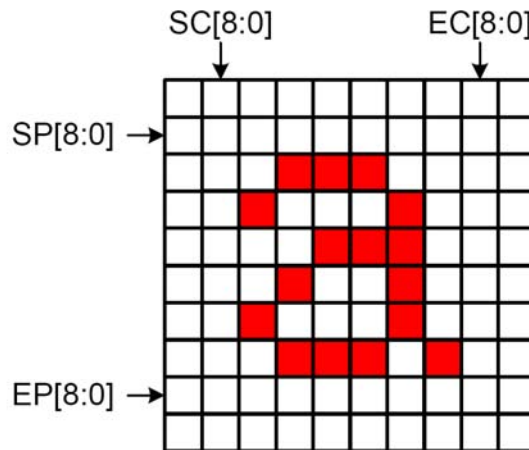

Restriction	SC [8:0] always must be equal to or less than EC[8:0]															
	7	GCM[7:0] = 70h : 480x864 MV(36h-B5)=0 : Parameter range : 0 ≤ SC[8:0] ≤ EC[8:0] ≤ 479(01DFh) MV(36h-B5)=1 : Parameter range : 0 ≤ SC[8:0] ≤ EC[8:0] ≤ 863(035Fh)														
	8	GCM[7:0] = 6Bh : 480x854 MV(36h-B5)=0 : Parameter range : 0 ≤ SC[8:0] ≤ EC[8:0] ≤ 479(01DFh) MV(36h-B5)=1 : Parameter range : 0 ≤ SC[8:0] ≤ EC[8:0] ≤ 853(0355h)														
	9	GCM[7:0] = 50h : 480x800 MV(36h-B5)=0 : Parameter range : 0 ≤ SC[8:0] ≤ EC[8:0] ≤ 479(01DFh) MV(36h-B5)=1 : Parameter range : 0 ≤ SC[8:0] ≤ EC[8:0] ≤ 799(031Fh)														
	10	GCM[7:0] = 28h : 480x720 MV(36h-B5)=0 : Parameter range : 0 ≤ SC[8:0] ≤ EC[8:0] ≤ 479(01DFh) MV(36h-B5)=1 : Parameter range : 0 ≤ SC[8:0] ≤ EC[8:0] ≤ 719(02CFh)														
	11	GCM[7:0] = 00h : 480x640 MV(36h-B5)=0 : Parameter range : 0 ≤ SC[8:0] ≤ EC[8:0] ≤ 479(01DFh) MV(36h-B5)=1 : Parameter range : 0 ≤ SC[8:0] ≤ EC[8:0] ≤ 639(027Fh)														
	12	GCM[7:0] = FEh : 480x360 MV(36h-B5)=0 : Parameter range : 0 ≤ SC[8:0] ≤ EC[8:0] ≤ 479(01DFh) MV(36h-B5)=1 : Parameter range : 0 ≤ SC[8:0] ≤ EC[8:0] ≤ 359(0167h)														
	Register Availability	<table border="1"> <thead> <tr> <th>Status</th> <th>Availability</th> </tr> </thead> <tbody> <tr> <td>Normal Mode On, Idle Mode Off, Sleep Out</td> <td>Yes</td> </tr> <tr> <td>Normal Mode On, Idle Mode On, Sleep Out</td> <td>Yes</td> </tr> <tr> <td>Partial Mode On, Idle Mode Off, Sleep Out</td> <td>Yes</td> </tr> <tr> <td>Partial Mode On, Idle Mode On, Sleep Out</td> <td>Yes</td> </tr> <tr> <td>Sleep In</td> <td>Yes</td> </tr> </tbody> </table>		Status	Availability	Normal Mode On, Idle Mode Off, Sleep Out	Yes	Normal Mode On, Idle Mode On, Sleep Out	Yes	Partial Mode On, Idle Mode Off, Sleep Out	Yes	Partial Mode On, Idle Mode On, Sleep Out	Yes	Sleep In	Yes	
		Status	Availability													
		Normal Mode On, Idle Mode Off, Sleep Out	Yes													
		Normal Mode On, Idle Mode On, Sleep Out	Yes													
		Partial Mode On, Idle Mode Off, Sleep Out	Yes													
Partial Mode On, Idle Mode On, Sleep Out		Yes														
Sleep In	Yes															
Default	<table border="1"> <thead> <tr> <th rowspan="2">Status</th> <th colspan="2">Default Value</th> </tr> <tr> <th>SC[8:0]</th> <th>EC[8:0](36h-B5=0)</th> </tr> </thead> <tbody> <tr> <td>Power On Sequence</td> <td>0000h</td> <td>01DFh</td> </tr> <tr> <td>SW Reset</td> <td>0000h</td> <td>01DFh</td> </tr> <tr> <td>HW Reset</td> <td>0000h</td> <td>01DFh</td> </tr> </tbody> </table>		Status	Default Value		SC[8:0]	EC[8:0](36h-B5=0)	Power On Sequence	0000h	01DFh	SW Reset	0000h	01DFh	HW Reset	0000h	01DFh
	Status	Default Value														
		SC[8:0]	EC[8:0](36h-B5=0)													
	Power On Sequence	0000h	01DFh													
SW Reset	0000h	01DFh														
HW Reset	0000h	01DFh														

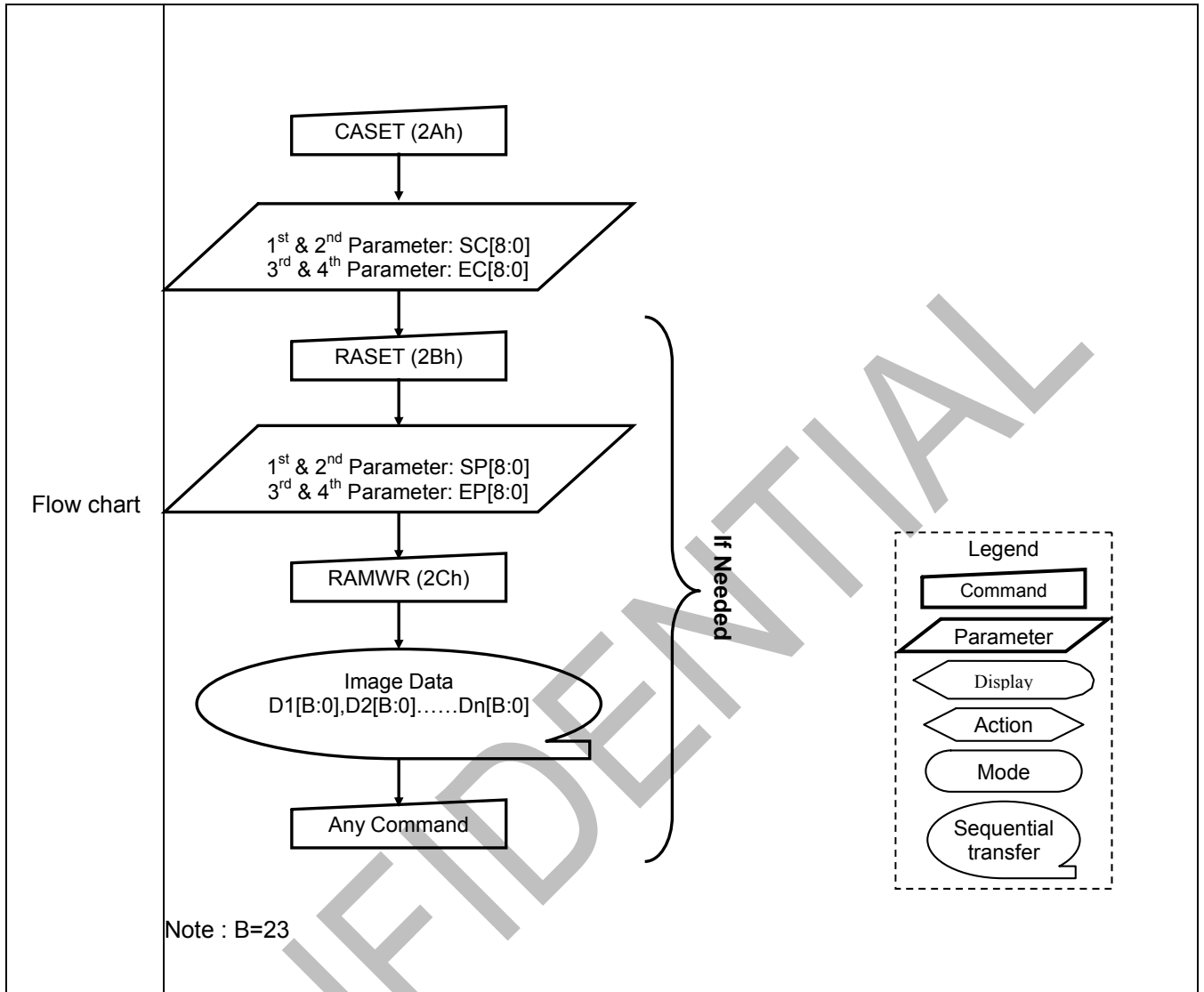

RASET (2B00h): Row Address Set

2B00H	RASET (Row Address Set)												HEX
	DCX	RDX	WRX	D15-8	D7	D6	D5	D4	D3	D2	D1	D0	
Command	0	1	↑	x	0	0	1	0	1	0	1	1	2B
1 st parameter	1	1	↑	x	0	0	0	0	0	0	0	SP8	00
2 nd parameter	1	1	↑	x	SP7	SP6	SP5	SP4	SP3	SP2	SP1	SP0	00
3 rd parameter	1	1	↑	x	0	0	0	0	0	0	0	EP8	03
4 th parameter	1	1	↑	x	EP7	EP6	EP5	EP4	EP3	EP2	EP1	EP0	1F

This command defines the page extent of the frame memory accessed by the host processor with the write_memory_continue and read_memory_continue command.

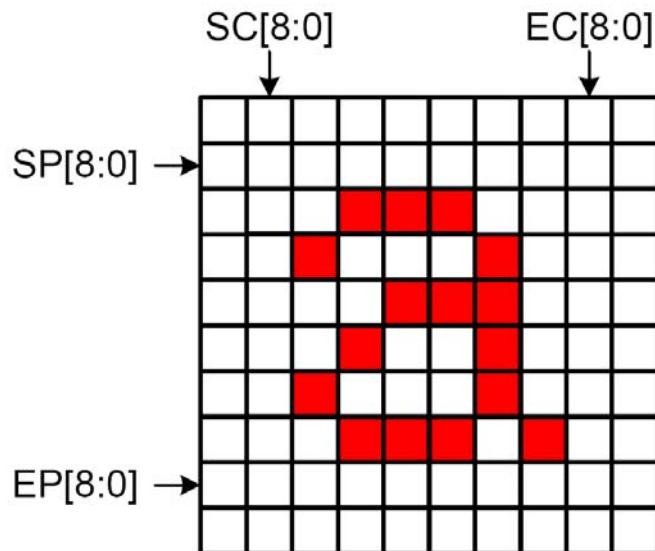

Description

Restriction	<p>SP [8:0] always must be equal to or less than EP [8:0].</p> <ol style="list-style-type: none"> GCM[7:0]= 70h : 480x864 MV(36h-B5)=0 : Parameter range : $0 \leq SP[8:0] \leq EP[8:0] \leq 863(035Fh)$ MV(36h-B5)=1 : Parameter range : $0 \leq SP[8:0] \leq EP[8:0] \leq 479(01DFh)$ GCM[7:0]= 6Bh : 480x854 MV(36h-B5)=0 : Parameter range : $0 \leq SP[8:0] \leq EP[8:0] \leq 853(0355h)$ MV(36h-B5)=1 : Parameter range : $0 \leq SP[8:0] \leq EP[8:0] \leq 479(01DFh)$ GCM[7:0]= 50h : 480x800 MV(36h-B5)=0 : Parameter range : $0 \leq SP[8:0] \leq EP[8:0] \leq 799(031Fh)$ MV(36h-B5)=1 : Parameter range : $0 \leq SP[8:0] \leq EP[8:0] \leq 479(01DFh)$ GCM[7:0]= 28h : 480x720 MV(36h-B5)=0 : Parameter range : $0 \leq SP[8:0] \leq EP[8:0] \leq 719(02CFh)$ MV(36h-B5)=1 : Parameter range : $0 \leq SP[8:0] \leq EP[8:0] \leq 479(01DFh)$ GCM[7:0]= 00h : 480x640 MV(36h-B5)=0 : Parameter range : $0 \leq SP[8:0] \leq EP[8:0] \leq 639(027Fh)$ MV(36h-B5)=1 : Parameter range : $0 \leq SP[8:0] \leq EP[8:0] \leq 479(01DFh)$ GCM[7:0]= FEh : 480x360 MV(36h-B5)=0 : Parameter range : $0 \leq SP[8:0] \leq EP[8:0] \leq 359(0167h)$ MV(36h-B5)=1 : Parameter range : $0 \leq SP[8:0] \leq EP[8:0] \leq 479(01DFh)$ 														
Register Availability	<table border="1"> <thead> <tr> <th>Status</th> <th>Availability</th> </tr> </thead> <tbody> <tr> <td>Normal Mode On, Idle Mode Off, Sleep Out</td> <td>Yes</td> </tr> <tr> <td>Normal Mode On, Idle Mode On, Sleep Out</td> <td>Yes</td> </tr> <tr> <td>Partial Mode On, Idle Mode Off, Sleep Out</td> <td>Yes</td> </tr> <tr> <td>Partial Mode On, Idle Mode On, Sleep Out</td> <td>Yes</td> </tr> <tr> <td>Sleep In</td> <td>Yes</td> </tr> </tbody> </table>	Status	Availability	Normal Mode On, Idle Mode Off, Sleep Out	Yes	Normal Mode On, Idle Mode On, Sleep Out	Yes	Partial Mode On, Idle Mode Off, Sleep Out	Yes	Partial Mode On, Idle Mode On, Sleep Out	Yes	Sleep In	Yes		
Status	Availability														
Normal Mode On, Idle Mode Off, Sleep Out	Yes														
Normal Mode On, Idle Mode On, Sleep Out	Yes														
Partial Mode On, Idle Mode Off, Sleep Out	Yes														
Partial Mode On, Idle Mode On, Sleep Out	Yes														
Sleep In	Yes														
Default	<table border="1"> <thead> <tr> <th rowspan="2">Status</th> <th colspan="2">Default Value</th> </tr> <tr> <th>SC[8:0]</th> <th>EC[8:0](36h-B5=0)</th> </tr> </thead> <tbody> <tr> <td>Power On Sequence</td> <td>0000h</td> <td>031Fh</td> </tr> <tr> <td>SW Reset</td> <td>0000h</td> <td>031Fh</td> </tr> <tr> <td>HW Reset</td> <td>0000h</td> <td>031Fh</td> </tr> </tbody> </table>	Status	Default Value		SC[8:0]	EC[8:0](36h-B5=0)	Power On Sequence	0000h	031Fh	SW Reset	0000h	031Fh	HW Reset	0000h	031Fh
Status	Default Value														
	SC[8:0]	EC[8:0](36h-B5=0)													
Power On Sequence	0000h	031Fh													
SW Reset	0000h	031Fh													
HW Reset	0000h	031Fh													

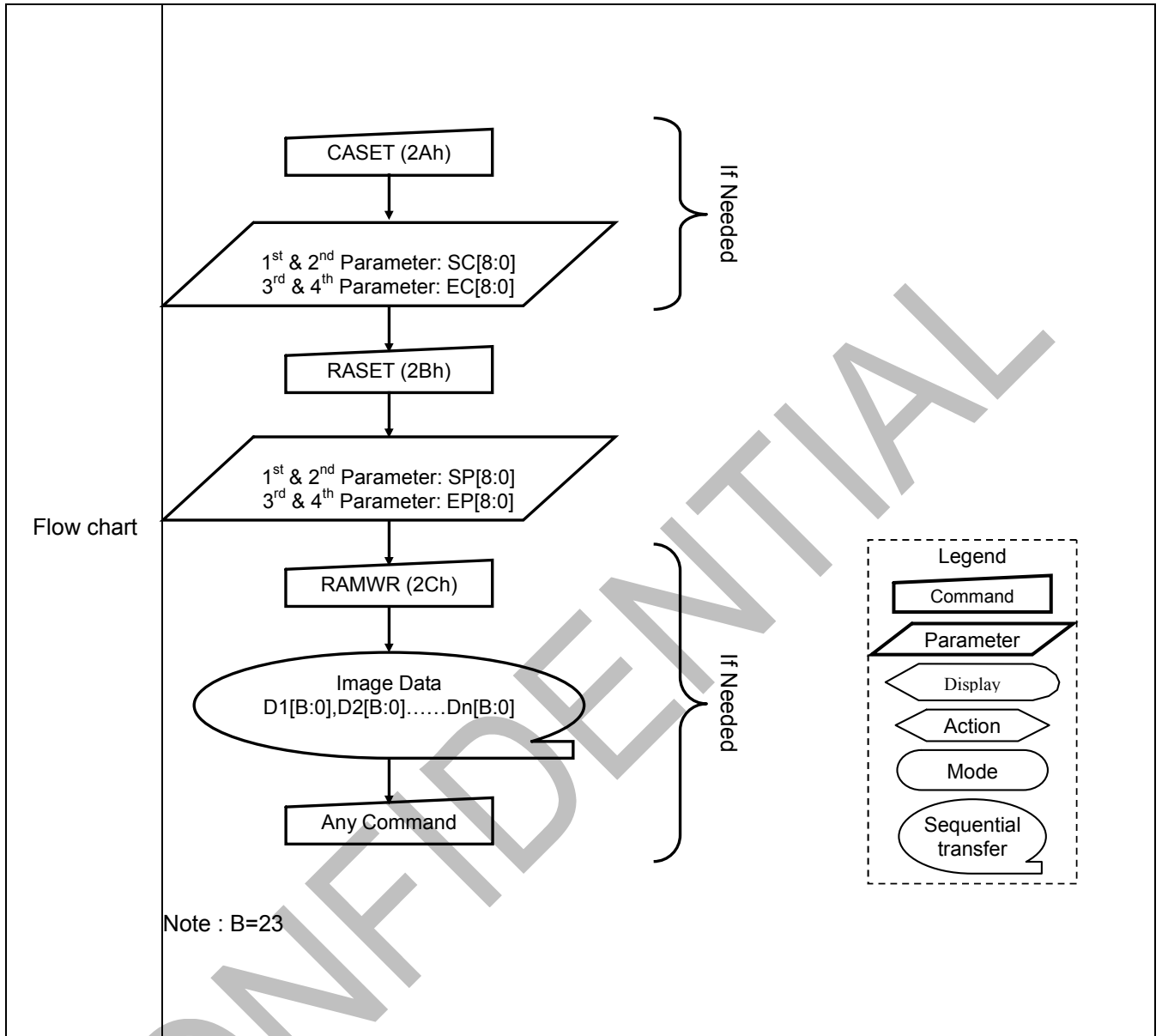

RAMWR (2C00h): Memory Write

2C00H	RAMWR (Memory Write)												
	DCX	RDX	WRX	D15-8	D7	D6	D5	D4	D3	D2	D1	D0	HEX
Command	0	1	↑	xx	0	0	1	0	1	1	0	0	2C
1 st pixel data	1	1	↑	D1[24..8]	D17	D16	D15	D14	D13	D12	D11	D10	
:	1	1	↑	Dx[24..8]	Dx7	Dx6	Dx5	Dx4	Dx3	Dx2	Dx1	Dx0	
N th pixel data	1	1	↑	Dn[24..8]	Dn7	Dn6	Dn5	Dn4	Dn3	Dn2	Dn1	Dn0	
Description	<p>This command transfers image data from the host processor to the display module's frame memory starting at the pixel location specified by preceding CASET (2Ah) and RASET (2Bh) commands.</p> <p>If MV(36h-B5) = 0:</p> <p>The column and page registers are reset to the Start Column (SC) and Start Page (SP), respectively. Pixel Data 1 is stored in frame memory at (SC, SP). The column register is then incremented and pixels are written to the frame memory until the column register equals the End Column (EC) value. The column register is then reset to SC and the page register is incremented. Pixels are written to the frame memory until the page register equals the End Page (EP) value or the host processor sends another command. If the number of pixels exceeds $(EC - SC + 1) * (EP - SP + 1)$ the extra pixels are ignored.</p> <p>If MV(36h-B5) = 1:</p> <p>The column and page registers are reset to the Start Column (SC) and Start Page (SP), respectively. Pixel Data 1 is stored in frame memory at (SC, SP). The page register is then incremented and pixels are written to the frame memory until the page register equals the End Page (EP) value. The page register is then reset to SP and the column register is incremented. Pixels are written to the frame memory until the column register equals the End column (EC) value or the host processor sends another command. If the number of pixels exceeds $(EC - SC + 1) * (EP - SP + 1)$ the extra pixels are ignored.</p>												
Restriction	<p>A Memory Write should follow a CASET(2Ah), RASET(2Bh) or MADCTR(36h) to define the write location. Otherwise, data written with RAMWR(2Ch) and any following RAMWRC(3Ch) commands is written to undefined locations.</p>												

<p>Register Availability</p>	<table border="1"> <thead> <tr> <th>Status</th> <th>Availability</th> </tr> </thead> <tbody> <tr> <td>Normal Mode On, Idle Mode Off, Sleep Out</td> <td>Yes</td> </tr> <tr> <td>Normal Mode On, Idle Mode On, Sleep Out</td> <td>Yes</td> </tr> <tr> <td>Partial Mode On, Idle Mode Off, Sleep Out</td> <td>Yes</td> </tr> <tr> <td>Partial Mode On, Idle Mode On, Sleep Out</td> <td>Yes</td> </tr> <tr> <td>Sleep In</td> <td>Yes</td> </tr> </tbody> </table>	Status	Availability	Normal Mode On, Idle Mode Off, Sleep Out	Yes	Normal Mode On, Idle Mode On, Sleep Out	Yes	Partial Mode On, Idle Mode Off, Sleep Out	Yes	Partial Mode On, Idle Mode On, Sleep Out	Yes	Sleep In	Yes
Status	Availability												
Normal Mode On, Idle Mode Off, Sleep Out	Yes												
Normal Mode On, Idle Mode On, Sleep Out	Yes												
Partial Mode On, Idle Mode Off, Sleep Out	Yes												
Partial Mode On, Idle Mode On, Sleep Out	Yes												
Sleep In	Yes												
<p>Default</p>	<table border="1"> <thead> <tr> <th>Status</th> <th>Default Value</th> </tr> </thead> <tbody> <tr> <td>Power On Sequence</td> <td>Contents of memory is set randomly</td> </tr> <tr> <td>SW Reset</td> <td>Contents of memory is not cleared</td> </tr> <tr> <td>HW Reset</td> <td>Contents of memory is not cleared</td> </tr> </tbody> </table>	Status	Default Value	Power On Sequence	Contents of memory is set randomly	SW Reset	Contents of memory is not cleared	HW Reset	Contents of memory is not cleared				
Status	Default Value												
Power On Sequence	Contents of memory is set randomly												
SW Reset	Contents of memory is not cleared												
HW Reset	Contents of memory is not cleared												
<p>Flow chart</p>	<pre> graph TD A[RAMWR (2Ch)] --> B([Image Data D1[B:0], D2[B:0], ..., Dn[B:0]]) B --> C[Any Command] </pre> <p>Note : B=23</p> <div style="border: 1px dashed black; padding: 5px;"> <p>Legend</p> <ul style="list-style-type: none"> Command Parameter Display Action Mode Sequential transfer </div>												

RAMRD (2E00h): Memory Read

2E00H	RAMRD (Memory Read)												
	DCX	RDX	WRX	D15-8	D7	D6	D5	D4	D3	D2	D1	D0	HEX
Command	0	1	↑	x	0	0	1	0	1	1	1	0	2E
1 st parameter	1	↑	1	x	x	x	x	x	x	x	x	x	x
2 nd parameter	1	↑	1	D1[24..8]	D17	D16	D15	D14	D13	D12	D11	D10	
:	1	↑	1	Dx[24..8]	Dx7	Dx6	Dx5	Dx4	Dx3	Dx2	Dx1	Dx0	
(N+1) th parameter	1	↑	1	Dn[24..8]	Dn7	Dn6	Dn5	Dn4	Dn3	Dn2	Dn1	Dn0	
Description	<p>This command transfers image data from the display module's frame memory to the host processor starting at the pixel location specified by preceding CASET (2Ah) and RASET (2Bh) commands.</p> <p>If MV(36h-B5) = 0: The column and page registers are reset to the Start Column (SC) and Start Page (SP), respectively. Pixels are read from frame memory at (SC, SP). The column register is then incremented and pixels read from the frame memory until the column register equals the End Column (EC) value. The column register is then reset to SC and the page register is incremented. Pixels are read from the frame memory until the page register equals the End Page (EP) value or the host processor sends another command.</p> <p>If MV(36h-B5) = 1: The column and page registers are reset to the Start Column (SC) and Start Page (SP), respectively. Pixels are read from frame memory at (SC, SP). The page register is then incremented and pixels read from the frame memory until the page register equals the End Page (EP) value. The page register is then reset to SP and the column register is incremented. Pixels are read from the frame memory until the column register equals the End Column (EC) value or the host processor sends another command.</p>												
Restriction													

Register Availability	<table border="1"> <thead> <tr> <th>Status</th> <th>Availability</th> </tr> </thead> <tbody> <tr> <td>Normal Mode On, Idle Mode Off, Sleep Out</td> <td>Yes</td> </tr> <tr> <td>Normal Mode On, Idle Mode On, Sleep Out</td> <td>Yes</td> </tr> <tr> <td>Partial Mode On, Idle Mode Off, Sleep Out</td> <td>Yes</td> </tr> <tr> <td>Partial Mode On, Idle Mode On, Sleep Out</td> <td>Yes</td> </tr> <tr> <td>Sleep In</td> <td>Yes</td> </tr> </tbody> </table>	Status	Availability	Normal Mode On, Idle Mode Off, Sleep Out	Yes	Normal Mode On, Idle Mode On, Sleep Out	Yes	Partial Mode On, Idle Mode Off, Sleep Out	Yes	Partial Mode On, Idle Mode On, Sleep Out	Yes	Sleep In	Yes
	Status	Availability											
	Normal Mode On, Idle Mode Off, Sleep Out	Yes											
	Normal Mode On, Idle Mode On, Sleep Out	Yes											
	Partial Mode On, Idle Mode Off, Sleep Out	Yes											
	Partial Mode On, Idle Mode On, Sleep Out	Yes											
Sleep In	Yes												
Default	<table border="1"> <thead> <tr> <th>Status</th> <th>Default Value</th> </tr> </thead> <tbody> <tr> <td>Power On Sequence</td> <td>Contents of memory is set randomly</td> </tr> <tr> <td>SW Reset</td> <td>Contents of memory is not cleared</td> </tr> <tr> <td>HW Reset</td> <td>Contents of memory is not cleared</td> </tr> </tbody> </table>	Status	Default Value	Power On Sequence	Contents of memory is set randomly	SW Reset	Contents of memory is not cleared	HW Reset	Contents of memory is not cleared				
	Status	Default Value											
	Power On Sequence	Contents of memory is set randomly											
	SW Reset	Contents of memory is not cleared											
HW Reset	Contents of memory is not cleared												
Flow chart	<pre> graph TD A[RAMRD (2Eh)] --> B[/Dummy Read/] B --> C([Image Data D1[B:0], D2[B:0].....Dn[B:0]]) C --> D[Any Command] </pre> <p>Note : B=23</p>												

PTLAR (3000h): Partial Area

3000H	PTLAR (Partial Area)												HEX
	DCX	RDX	WRX	D15-8	D7	D6	D5	D4	D3	D2	D1	D0	
Command	0	1	↑	x	0	0	1	1	0	0	0	0	30
1 st parameter	1	1	↑	x	0	0	0	0	0	0	0	SR8	00
2 nd parameter	1	1	↑	x	SR7	SR6	SR5	SR4	SR3	SR2	SR1	SR0	00
3 rd parameter	1	1	↑	x	0	0	0	0	0	0	0	ER8	03
4 th parameter	1	1	↑	x	ER7	ER6	ER5	ER4	ER3	ER2	ER1	ER0	1F

This command defines the Partial Display mode's display area. There are two parameters associated with this command, the first defines the Start Row (SR) and the second the End Row (ER), as illustrated in the following figure. SR and ER refer to the Frame Memory.

-If End Row > Start Row, when ML(36h-B4) = '0'

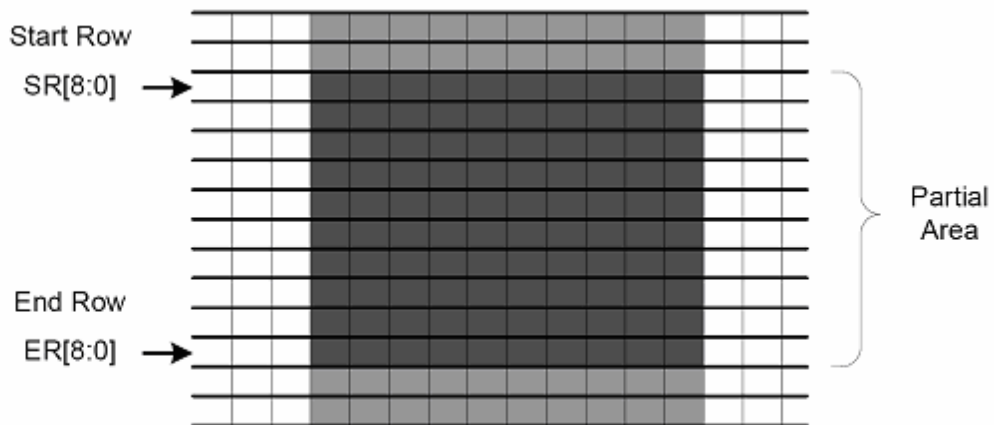

Description

-If End Row > Start Row, when ML(36h-B4) = '1'

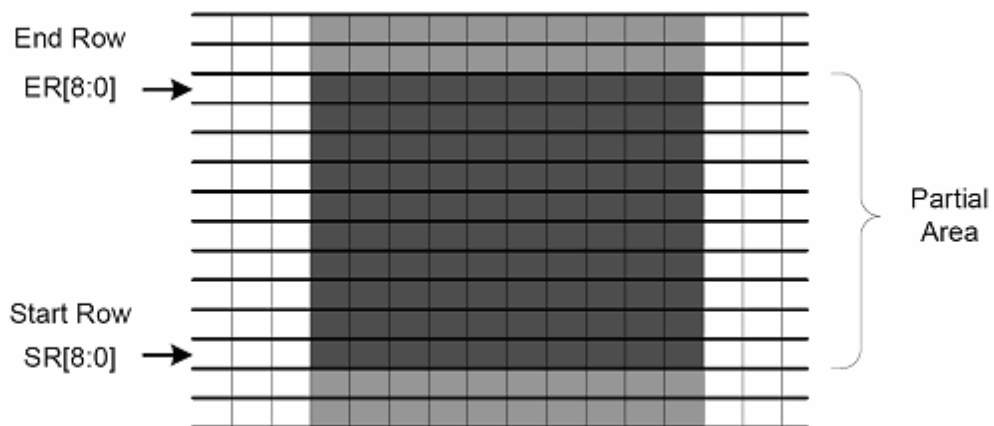

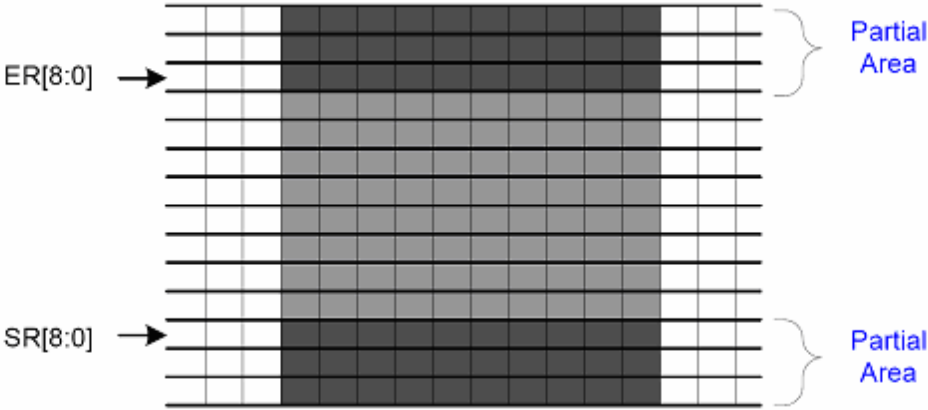
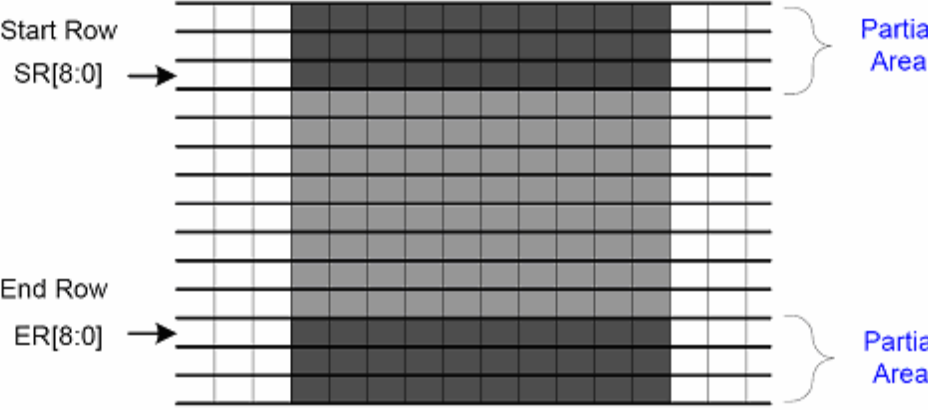
	<p>-If End Row < Start Row, when ML(36h-B4) = '0'</p>  <p>-If End Row < Start Row, when ML(36h-B4) = '1'</p>  <p>-If End Row = Start Row then the Partial Area will be one row deep.</p>
<p>Restriction</p>	<p>CGM[7:0] = "70h" (480 x 864): $0 \leq SR[15:0], ER[15:0] \leq 863$ (035Fh), $ER-SR \leq 863$ (035Fh)</p> <p>CGM[7:0] = "6Bh" (480 x 854): $0 \leq SR[15:0], ER[15:0] \leq 853$ (0355h), $ER-SR \leq 853$ (0355h)</p> <p>CGM[7:0] = "50h" (480 x 800): $0 \leq SR[15:0], ER[15:0] \leq 799$ (031Fh), $ER-SR \leq 799$ (031Fh)</p> <p>CGM[7:0] = "28h" (480 x 720): $0 \leq SR[15:0], ER[15:0] \leq 719$ (02CFh), $ER-SR \leq 719$ (02CFh)</p> <p>CGM[7:0] = "00h" (480 x 640): $0 \leq SR[15:0], ER[15:0] \leq 639$ (027Fh), $ER-SR \leq 639$ (027Fh)</p> <p>CGM[7:0] = "FEh" (480 x 360): $0 \leq SR[15:0], ER[15:0] \leq 359$ (0167h), $ER-SR \leq 359$ (0167h)</p>

Register Availability	Status	Availability
	Normal Mode On, Idle Mode Off, Sleep Out	Yes
	Normal Mode On, Idle Mode On, Sleep Out	Yes
	Partial Mode On, Idle Mode Off, Sleep Out	Yes
	Partial Mode On, Idle Mode On, Sleep Out	Yes
	Sleep In	Yes

Default	Status	Default Value	
		SR[8:0]	ER[8:0]
	Power On Sequence	0000h	031Fh
	SW Reset	0000h	031Fh
	HW Reset	0000h	031Fh

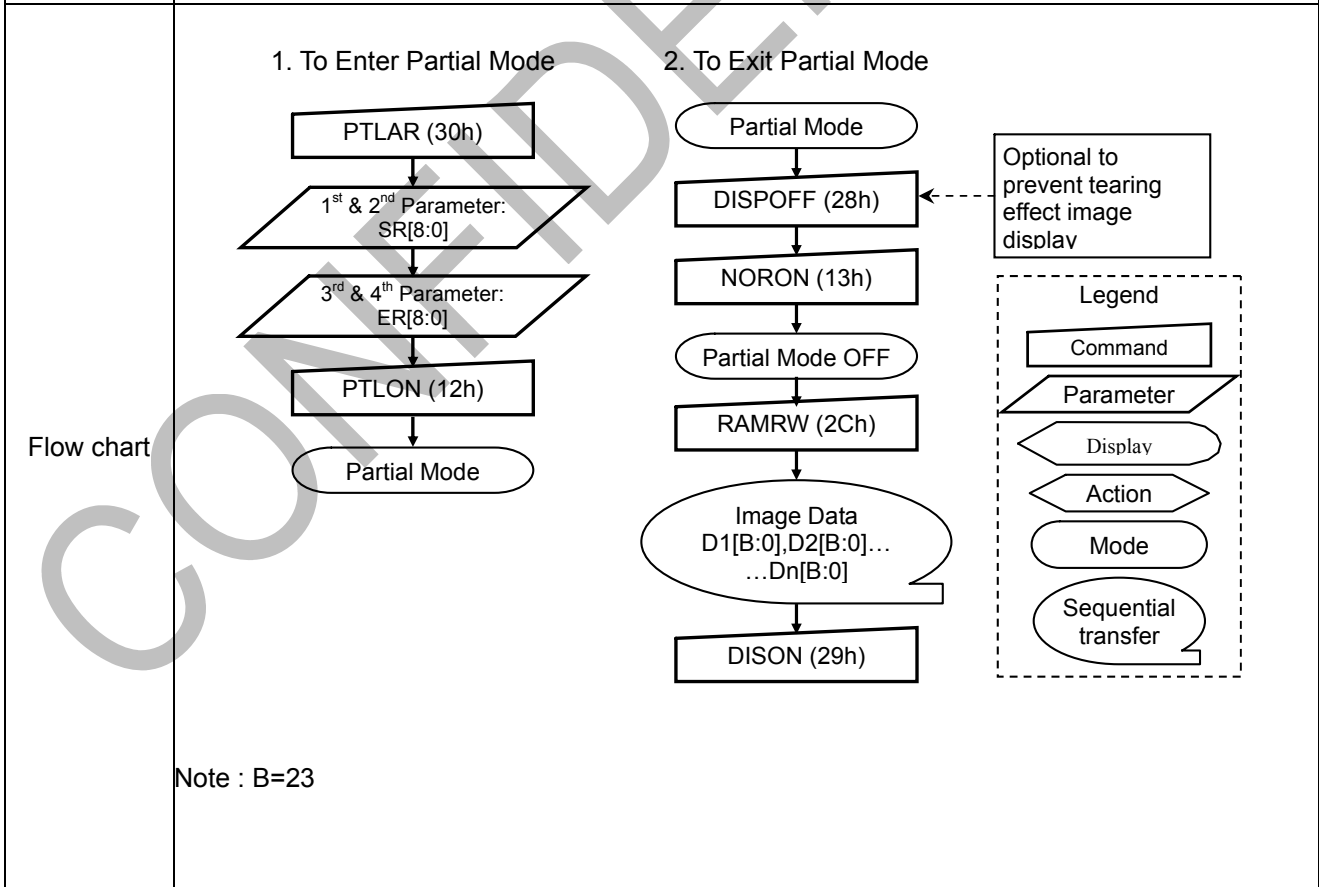

TEOFF (3400h): Tearing Effect Line OFF

3400H	TEOFF (Tearing Effect Line OFF)																								
	DCX	RDX	WRX	D15-8	D7	D6	D5	D4	D3	D2	D1	D0	HEX												
Command	0	1	↑	x	0	0	1	1	0	1	0	0	34												
Parameter	NO PARAMETER																								
Description	This command turns off the display module's Tearing Effect output signal on the TE signal line.																								
Restriction	This command has no effect when the Tearing Effect output is already off.																								
Register Availability	<table border="1"> <thead> <tr> <th>Status</th> <th>Availability</th> </tr> </thead> <tbody> <tr> <td>Normal Mode On, Idle Mode Off, Sleep Out</td> <td>Yes</td> </tr> <tr> <td>Normal Mode On, Idle Mode On, Sleep Out</td> <td>Yes</td> </tr> <tr> <td>Partial Mode On, Idle Mode Off, Sleep Out</td> <td>Yes</td> </tr> <tr> <td>Partial Mode On, Idle Mode On, Sleep Out</td> <td>Yes</td> </tr> <tr> <td>Sleep In</td> <td>Yes</td> </tr> </tbody> </table>													Status	Availability	Normal Mode On, Idle Mode Off, Sleep Out	Yes	Normal Mode On, Idle Mode On, Sleep Out	Yes	Partial Mode On, Idle Mode Off, Sleep Out	Yes	Partial Mode On, Idle Mode On, Sleep Out	Yes	Sleep In	Yes
Status	Availability																								
Normal Mode On, Idle Mode Off, Sleep Out	Yes																								
Normal Mode On, Idle Mode On, Sleep Out	Yes																								
Partial Mode On, Idle Mode Off, Sleep Out	Yes																								
Partial Mode On, Idle Mode On, Sleep Out	Yes																								
Sleep In	Yes																								
Default	<table border="1"> <thead> <tr> <th>Status</th> <th>Default Value</th> </tr> </thead> <tbody> <tr> <td>Power On Sequence</td> <td>OFF</td> </tr> <tr> <td>SW Reset</td> <td>OFF</td> </tr> <tr> <td>HW Reset</td> <td>OFF</td> </tr> </tbody> </table>													Status	Default Value	Power On Sequence	OFF	SW Reset	OFF	HW Reset	OFF				
Status	Default Value																								
Power On Sequence	OFF																								
SW Reset	OFF																								
HW Reset	OFF																								
Flow Chart	<pre> graph TD A([TE Line Output ON]) --> B[TEOFF (34h)] B --> C([TE Line Output OFF]) </pre> <p>Legend</p> <ul style="list-style-type: none"> Command: Rectangle Parameter: Parallelogram Display: Oval Action: Arrowhead Mode: Rounded Rectangle Sequential transfer: Oval with tail 																								

TEON (3500h): Tearing Effect Line ON

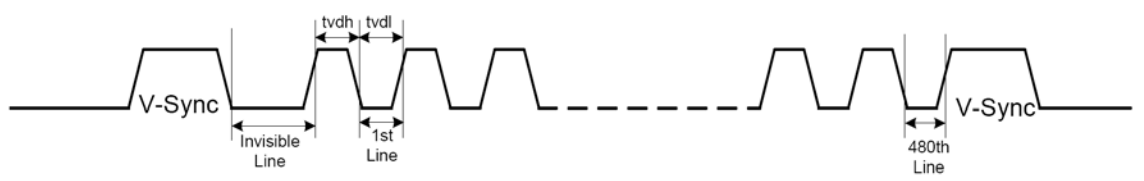
3500H	TEON (Tearing Effect Line ON)												
	DCX	RDX	WRX	D15-8	D7	D6	D5	D4	D3	D2	D1	D0	HEX
Command	0	1	↑	x	0	0	1	1	0	1	0	1	35
1 st parameter	1	1	↑	x	0	0	0	0	0	0	0	TELOM	00
Description	<p>This command turns on the tearing Effect output signal on the TE signal line. The TE signal is not affected by changing MADCTR (36h) B4 (Line Address Order).</p> <p>The Tearing Effect Line On has one parameter that describes the Tearing Effect Output Line mode.</p> <p>If TELOM = 0: The Tearing Effect Output line consists of V-Blanking information only.</p>  <p>If TELOM = 1: The Tearing Effect Output Line consists of both V-Blanking and H-Blanking information.</p>  <p>The Tearing Effect Output line shall be active low when the display module is in Sleep mode.</p>												
	Restriction	This command has no effect when Tearing Effect output is already ON.											
Register Availability	Status		Availability										
	Normal Mode On, Idle Mode Off, Sleep Out		Yes										
	Normal Mode On, Idle Mode On, Sleep Out		Yes										
	Partial Mode On, Idle Mode Off, Sleep Out		Yes										
	Partial Mode On, Idle Mode On, Sleep Out		Yes										
	Sleep In		Yes										

<p>Default</p>	<table border="1"> <thead> <tr> <th>Status</th> <th>Default Value</th> </tr> </thead> <tbody> <tr> <td>Power On Sequence</td> <td>OFF</td> </tr> <tr> <td>SW Reset</td> <td>OFF</td> </tr> <tr> <td>HW Reset</td> <td>OFF</td> </tr> </tbody> </table>	Status	Default Value	Power On Sequence	OFF	SW Reset	OFF	HW Reset	OFF
Status	Default Value								
Power On Sequence	OFF								
SW Reset	OFF								
HW Reset	OFF								
<p>Flow Chart</p>	<pre> graph TD A([TE Line Output OFF]) --> B[TEON (35h)] B --> C[/1st Parameter: TELOM/] C --> D([TE Line Output ON]) </pre> <p>Legend</p> <ul style="list-style-type: none"> Command: Rectangle Parameter: Parallelogram Display: Oval Action: Arrowhead Mode: Rounded rectangle Sequential transfer: Oval with tail 								

CONFIDENTIAL

MADCTR (3600h): Memory Data Access Control

3600H	MADCTR (Memory Data Access Control)												
	DCX	RDX	WRX	D24-8	D7	D6	D5	D4	D3	D2	D1	D0	HEX
Command	0	1	↑	x	0	0	1	1	0	1	1	0	36
1 st parameter	1	1	↑	x	B7	B6	B5	B4	B3	B2	B1	B0	00

This command defines read/write scanning direction of frame memory. This command makes no change on the other driver status.

Description

Bit	Symbol	Description	Comment
B7	MY	Row Address Order	'1' = Bottom to Top '0' = Top to Bottom
B6	MX	Column Address Order	'1' = Right to Left '0' = Left to Right
B5	MV	Row/Column Order (MV)	'1' = Row/column exchange '0' = Normal
B4	ML	Vertical Refresh Order	'0' =LCD Refresh Top to Bottom '1' =LCD Refresh Bottom to Top
B3	RGB	RGB/BGR Order	'1' =BGR, "0"=RGB
B2	MH	Horizontal Refresh Order	'0' =LCD Refresh Left to Right '1' =LCD Refresh Right to Left
B1	H_FLIP	Horizontal Flip	'0' = Normal display '1' = Flipped display
B0	V_FLIP	Vertical Flip	'0' = Normal display '1' = Flipped display

B5	B6	B7	Image in Frame Memory	B5	B6	B7	Image in Frame Memory
0	0	0		1	0	0	
0	0	1		1	0	1	
0	1	0		1	1	0	
0	1	1		1	1	1	

B3 = 0

Memory: Sent RGB → Display Panel:

B3 = 1

Memory: Sent BGR → Display Panel:

Restriction

<p>Register Availability</p>	<table border="1"> <thead> <tr> <th>Status</th> <th>Availability</th> </tr> </thead> <tbody> <tr> <td>Normal Mode On, Idle Mode Off, Sleep Out</td> <td>Yes</td> </tr> <tr> <td>Normal Mode On, Idle Mode On, Sleep Out</td> <td>Yes</td> </tr> <tr> <td>Partial Mode On, Idle Mode Off, Sleep Out</td> <td>Yes</td> </tr> <tr> <td>Partial Mode On, Idle Mode On, Sleep Out</td> <td>Yes</td> </tr> <tr> <td>Sleep In</td> <td>Yes</td> </tr> </tbody> </table>	Status	Availability	Normal Mode On, Idle Mode Off, Sleep Out	Yes	Normal Mode On, Idle Mode On, Sleep Out	Yes	Partial Mode On, Idle Mode Off, Sleep Out	Yes	Partial Mode On, Idle Mode On, Sleep Out	Yes	Sleep In	Yes
Status	Availability												
Normal Mode On, Idle Mode Off, Sleep Out	Yes												
Normal Mode On, Idle Mode On, Sleep Out	Yes												
Partial Mode On, Idle Mode Off, Sleep Out	Yes												
Partial Mode On, Idle Mode On, Sleep Out	Yes												
Sleep In	Yes												
<p>Default</p>	<table border="1"> <thead> <tr> <th>Status</th> <th>Default Value</th> </tr> </thead> <tbody> <tr> <td>Power On Sequence</td> <td>00h</td> </tr> <tr> <td>SW Reset</td> <td>No Change</td> </tr> <tr> <td>HW Reset</td> <td>00h</td> </tr> </tbody> </table>	Status	Default Value	Power On Sequence	00h	SW Reset	No Change	HW Reset	00h				
Status	Default Value												
Power On Sequence	00h												
SW Reset	No Change												
HW Reset	00h												
<p>Flow chart</p>	<pre> graph TD A[MADCTR (36h)] --> B[/1st Parameter/] </pre> <p>Legend</p> <ul style="list-style-type: none"> Command: Rectangle Parameter: Parallelogram Display: Oval Action: Arrow Mode: Rounded Rectangle Sequential transfer: Speech bubble 												

IDMOFF (3800h): Idle Mode Off

3800H	IDMOFF (Idle Mode Off)												HEX												
	DCX	RDX	WRX	D15-8	D7	D6	D5	D4	D3	D2	D1	D0													
Command	0	1	↑	x	0	0	1	1	1	0	0	0	38												
Parameter	NO PARAMETER																								
Description	This command causes the display module to exit Idle mode.																								
Restriction	This command has no effect when the display module is not in Idle mode.																								
Register Availability	<table border="1"> <thead> <tr> <th>Status</th> <th>Availability</th> </tr> </thead> <tbody> <tr> <td>Normal Mode On, Idle Mode Off, Sleep Out</td> <td>Yes</td> </tr> <tr> <td>Normal Mode On, Idle Mode On, Sleep Out</td> <td>Yes</td> </tr> <tr> <td>Partial Mode On, Idle Mode Off, Sleep Out</td> <td>Yes</td> </tr> <tr> <td>Partial Mode On, Idle Mode On, Sleep Out</td> <td>Yes</td> </tr> <tr> <td>Sleep In</td> <td>Yes</td> </tr> </tbody> </table>													Status	Availability	Normal Mode On, Idle Mode Off, Sleep Out	Yes	Normal Mode On, Idle Mode On, Sleep Out	Yes	Partial Mode On, Idle Mode Off, Sleep Out	Yes	Partial Mode On, Idle Mode On, Sleep Out	Yes	Sleep In	Yes
Status	Availability																								
Normal Mode On, Idle Mode Off, Sleep Out	Yes																								
Normal Mode On, Idle Mode On, Sleep Out	Yes																								
Partial Mode On, Idle Mode Off, Sleep Out	Yes																								
Partial Mode On, Idle Mode On, Sleep Out	Yes																								
Sleep In	Yes																								
Default	<table border="1"> <thead> <tr> <th>Status</th> <th>Default Value</th> </tr> </thead> <tbody> <tr> <td>Power On Sequence</td> <td>Idle Mode Off</td> </tr> <tr> <td>SW Reset</td> <td>Idle Mode Off</td> </tr> <tr> <td>HW Reset</td> <td>Idle Mode Off</td> </tr> </tbody> </table>													Status	Default Value	Power On Sequence	Idle Mode Off	SW Reset	Idle Mode Off	HW Reset	Idle Mode Off				
Status	Default Value																								
Power On Sequence	Idle Mode Off																								
SW Reset	Idle Mode Off																								
HW Reset	Idle Mode Off																								
Flow Chart	<pre> graph TD A([Idle mode ON]) --> B[IDMOFF (38h)] B --> C([Idle mode OFF]) </pre> <p>Legend:</p> <ul style="list-style-type: none"> Command: Rectangle Parameter: Parallelogram Display: Oval Action: Arrow Mode: Rounded Rectangle Sequential transfer: Oval with tail 																								

IDMON (3900h): Enter_idle_mode

3900H	Enter_idle_mode																																																
	DCX	RDX	WRX	D15-8	D7	D6	D5	D4	D3	D2	D1	D0	HEX																																				
Command	0	1	↑	x	0	0	1	1	1	0	0	1	39																																				
Parameter	NO PARAMETER																																																
Description	<p>This command causes the display module to enter Idle Mode.</p> <p>In Idle Mode, color expression is reduced. Colors are shown on the display device using the MSB of each of the R, G and B color components in the frame memory.</p>																																																
	<div style="display: flex; justify-content: space-around; align-items: center;"> <div style="text-align: center;"> <p>Memory</p> </div> <div style="font-size: 2em; margin: 0 20px;">→</div> <div style="text-align: center;"> <p>Panel Display</p> </div> </div>																																																
	<table border="1" style="width: 100%; border-collapse: collapse; text-align: center;"> <thead> <tr> <th>Color</th> <th>R7 R6 R5 R4 R3 R2 R1 R0</th> <th>G7 G6 G5 G4 G3 G2 G1 G0</th> <th>B7 B6 B5 B4 B3 B2 B1 B0</th> </tr> </thead> <tbody> <tr> <td>Black</td> <td>0XXXXXXX</td> <td>0XXXXXXX</td> <td>0XXXXXXX</td> </tr> <tr> <td>Blue</td> <td>0XXXXXXX</td> <td>0XXXXXXX</td> <td>1XXXXXXX</td> </tr> <tr> <td>Red</td> <td>1XXXXXXX</td> <td>0XXXXXXX</td> <td>0XXXXXXX</td> </tr> <tr> <td>Magenta</td> <td>1XXXXXXX</td> <td>0XXXXXXX</td> <td>1XXXXXXX</td> </tr> <tr> <td>Green</td> <td>0XXXXXXX</td> <td>1XXXXXXX</td> <td>0XXXXXXX</td> </tr> <tr> <td>Cyan</td> <td>0XXXXXXX</td> <td>1XXXXXXX</td> <td>1XXXXXXX</td> </tr> <tr> <td>Yellow</td> <td>1XXXXXXX</td> <td>1XXXXXXX</td> <td>0XXXXXXX</td> </tr> <tr> <td>White</td> <td>1XXXXXXX</td> <td>1XXXXXXX</td> <td>1XXXXXXX</td> </tr> </tbody> </table>													Color	R7 R6 R5 R4 R3 R2 R1 R0	G7 G6 G5 G4 G3 G2 G1 G0	B7 B6 B5 B4 B3 B2 B1 B0	Black	0XXXXXXX	0XXXXXXX	0XXXXXXX	Blue	0XXXXXXX	0XXXXXXX	1XXXXXXX	Red	1XXXXXXX	0XXXXXXX	0XXXXXXX	Magenta	1XXXXXXX	0XXXXXXX	1XXXXXXX	Green	0XXXXXXX	1XXXXXXX	0XXXXXXX	Cyan	0XXXXXXX	1XXXXXXX	1XXXXXXX	Yellow	1XXXXXXX	1XXXXXXX	0XXXXXXX	White	1XXXXXXX	1XXXXXXX	1XXXXXXX
Color	R7 R6 R5 R4 R3 R2 R1 R0	G7 G6 G5 G4 G3 G2 G1 G0	B7 B6 B5 B4 B3 B2 B1 B0																																														
Black	0XXXXXXX	0XXXXXXX	0XXXXXXX																																														
Blue	0XXXXXXX	0XXXXXXX	1XXXXXXX																																														
Red	1XXXXXXX	0XXXXXXX	0XXXXXXX																																														
Magenta	1XXXXXXX	0XXXXXXX	1XXXXXXX																																														
Green	0XXXXXXX	1XXXXXXX	0XXXXXXX																																														
Cyan	0XXXXXXX	1XXXXXXX	1XXXXXXX																																														
Yellow	1XXXXXXX	1XXXXXXX	0XXXXXXX																																														
White	1XXXXXXX	1XXXXXXX	1XXXXXXX																																														
Restriction	This command has no effect when module is already in idle on mode.																																																
Register Availability	<table border="1" style="width: 100%; border-collapse: collapse; text-align: center;"> <thead> <tr> <th>Status</th> <th>Availability</th> </tr> </thead> <tbody> <tr> <td>Normal Mode On, Idle Mode Off, Sleep Out</td> <td>Yes</td> </tr> <tr> <td>Normal Mode On, Idle Mode On, Sleep Out</td> <td>Yes</td> </tr> <tr> <td>Partial Mode On, Idle Mode Off, Sleep Out</td> <td>Yes</td> </tr> <tr> <td>Partial Mode On, Idle Mode On, Sleep Out</td> <td>Yes</td> </tr> <tr> <td>Sleep In</td> <td>Yes</td> </tr> </tbody> </table>													Status	Availability	Normal Mode On, Idle Mode Off, Sleep Out	Yes	Normal Mode On, Idle Mode On, Sleep Out	Yes	Partial Mode On, Idle Mode Off, Sleep Out	Yes	Partial Mode On, Idle Mode On, Sleep Out	Yes	Sleep In	Yes																								
Status	Availability																																																
Normal Mode On, Idle Mode Off, Sleep Out	Yes																																																
Normal Mode On, Idle Mode On, Sleep Out	Yes																																																
Partial Mode On, Idle Mode Off, Sleep Out	Yes																																																
Partial Mode On, Idle Mode On, Sleep Out	Yes																																																
Sleep In	Yes																																																

Default	<table border="1" data-bbox="568 264 1193 398"> <thead> <tr> <th>Status</th> <th>Default Value</th> </tr> </thead> <tbody> <tr> <td>Power On Sequence</td> <td>Idle Mode Off</td> </tr> <tr> <td>SW Reset</td> <td>Idle Mode Off</td> </tr> <tr> <td>HW Reset</td> <td>Idle Mode Off</td> </tr> </tbody> </table>	Status	Default Value	Power On Sequence	Idle Mode Off	SW Reset	Idle Mode Off	HW Reset	Idle Mode Off
Status	Default Value								
Power On Sequence	Idle Mode Off								
SW Reset	Idle Mode Off								
HW Reset	Idle Mode Off								
Flow Chart	 <pre> graph TD A([Idle mode OFF]) --> B[IDMON (39h)] B --> C([Idle mode ON]) </pre> <p>Legend</p> <ul style="list-style-type: none"> Command: Rectangle Parameter: Parallelogram Display: Pointed oval Action: Pointed oval Mode: Rounded rectangle Sequential transfer: Oval with tail 								

CONFIDENTIAL

COLMOD (3A00h): Interface Pixel Format

3A00H	COLMOD (Interface Pixel Format)												HEX																																			
	DCX	RDX	WRX	D15-8	D7	D6	D5	D4	D3	D2	D1	D0																																				
Command	0	1	↑	x	0	0	1	1	1	0	1	0	3A																																			
1 st parameter	1	1	↑	x	0	D6	D5	D4	0	D2	D1	D0	66																																			
Description	<p>This command sets the pixel format for the RGB image data used by the interface.</p> <p>Bits D[6:4] – DPI Pixel Format Definition Bits D[2:0] – DBI Pixel Format Definition Bits D7 and D3 are not used.</p> <p>If a particular interface, either DBI or DPI, is not used then the corresponding bits in the parameter are ignored.</p>																																															
	<table border="1"> <thead> <tr> <th>Control Interface Color Format</th> <th>D6/D2</th> <th>D5/D1</th> <th>D4/D0</th> </tr> </thead> <tbody> <tr> <td>Not defined</td> <td>0</td> <td>0</td> <td>0</td> </tr> <tr> <td>Not defined</td> <td>0</td> <td>0</td> <td>1</td> </tr> <tr> <td>Not defined</td> <td>0</td> <td>1</td> <td>0</td> </tr> <tr> <td>Not defined</td> <td>0</td> <td>1</td> <td>1</td> </tr> <tr> <td>Not defined</td> <td>1</td> <td>0</td> <td>0</td> </tr> <tr> <td>16bit/pixel (65,536 colors)</td> <td>1</td> <td>0</td> <td>1</td> </tr> <tr> <td>18bit/pixel (262,144 colors)</td> <td>1</td> <td>1</td> <td>0</td> </tr> <tr> <td>24bit/pixel (16.7M colors)</td> <td>1</td> <td>1</td> <td>1</td> </tr> </tbody> </table>													Control Interface Color Format	D6/D2	D5/D1	D4/D0	Not defined	0	0	0	Not defined	0	0	1	Not defined	0	1	0	Not defined	0	1	1	Not defined	1	0	0	16bit/pixel (65,536 colors)	1	0	1	18bit/pixel (262,144 colors)	1	1	0	24bit/pixel (16.7M colors)	1	1
Control Interface Color Format	D6/D2	D5/D1	D4/D0																																													
Not defined	0	0	0																																													
Not defined	0	0	1																																													
Not defined	0	1	0																																													
Not defined	0	1	1																																													
Not defined	1	0	0																																													
16bit/pixel (65,536 colors)	1	0	1																																													
18bit/pixel (262,144 colors)	1	1	0																																													
24bit/pixel (16.7M colors)	1	1	1																																													
Restriction	There is no visible effect until the Frame Memory is written to.																																															
Register Availability	<table border="1"> <thead> <tr> <th>Status</th> <th>Availability</th> </tr> </thead> <tbody> <tr> <td>Normal Mode On, Idle Mode Off, Sleep Out</td> <td>Yes</td> </tr> <tr> <td>Normal Mode On, Idle Mode On, Sleep Out</td> <td>Yes</td> </tr> <tr> <td>Partial Mode On, Idle Mode Off, Sleep Out</td> <td>Yes</td> </tr> <tr> <td>Partial Mode On, Idle Mode On, Sleep Out</td> <td>Yes</td> </tr> <tr> <td>Sleep In</td> <td>Yes</td> </tr> </tbody> </table>													Status	Availability	Normal Mode On, Idle Mode Off, Sleep Out	Yes	Normal Mode On, Idle Mode On, Sleep Out	Yes	Partial Mode On, Idle Mode Off, Sleep Out	Yes	Partial Mode On, Idle Mode On, Sleep Out	Yes	Sleep In	Yes																							
	Status	Availability																																														
Normal Mode On, Idle Mode Off, Sleep Out	Yes																																															
Normal Mode On, Idle Mode On, Sleep Out	Yes																																															
Partial Mode On, Idle Mode Off, Sleep Out	Yes																																															
Partial Mode On, Idle Mode On, Sleep Out	Yes																																															
Sleep In	Yes																																															
Default	<table border="1"> <thead> <tr> <th>Status</th> <th>Default Value</th> </tr> </thead> <tbody> <tr> <td>Power On Sequence</td> <td>66h</td> </tr> <tr> <td>SW Reset</td> <td>No Change</td> </tr> <tr> <td>HW Reset</td> <td>66h</td> </tr> </tbody> </table>													Status	Default Value	Power On Sequence	66h	SW Reset	No Change	HW Reset	66h																											
Status	Default Value																																															
Power On Sequence	66h																																															
SW Reset	No Change																																															
HW Reset	66h																																															

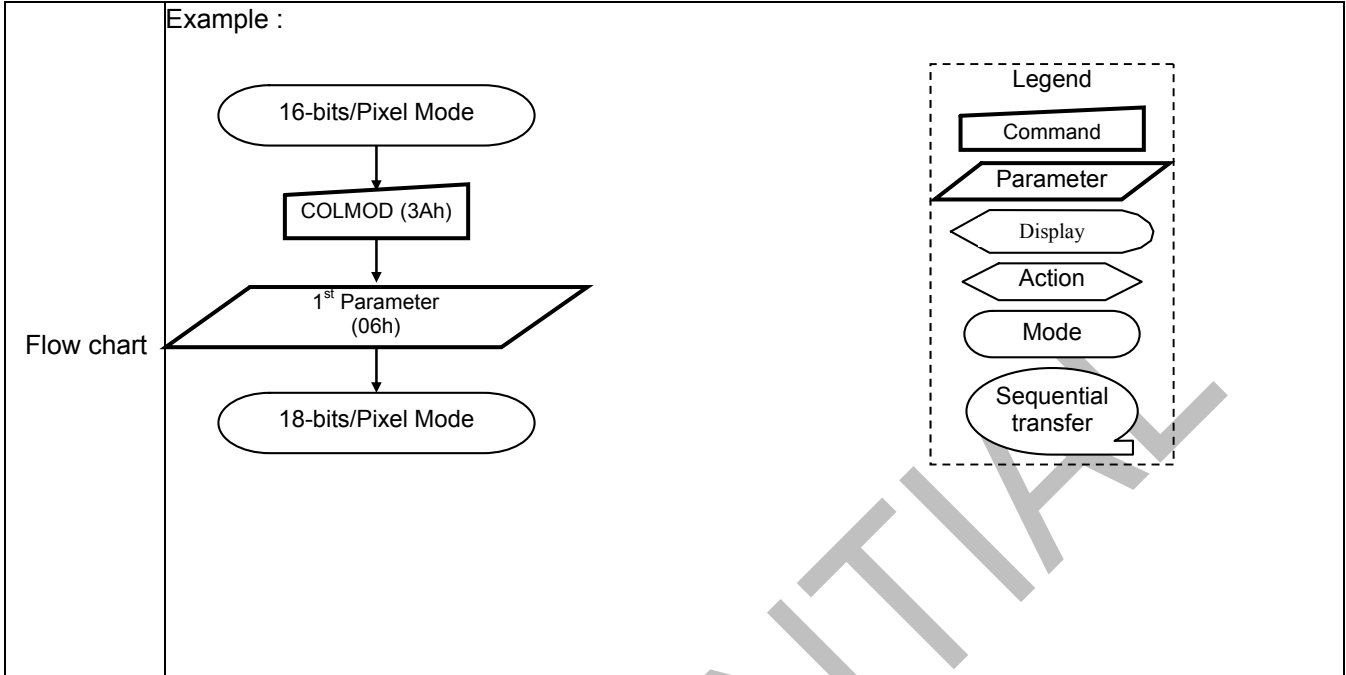

CONFIDENTIAL

RAMWRC(3C00h) : Write_Memory_Continue

3C00H	Write_Memory_Continue												HEX
	DCX	RDX	WRX	D15-8	D7	D6	D5	D4	D3	D2	D1	D0	
Command	0	1	↑	x	0	0	1	1	1	1	0	0	3C
1 st parameter	1	1	↑	D1[24..8]	D1[7]	D1[6]	D1[5]	D1[4]	D1[3]	D1[2]	D1[1]	D1[0]	
X st parameter	1	1	↑	Dx[24..8]	Dx[7]	Dx[6]	Dx[5]	Dx[4]	Dx[3]	Dx[2]	Dx[1]	Dx[0]	
N st parameter	1	1	↑	Dn[24..8]	Dn[7]	Dn[6]	Dn[5]	Dn[4]	Dn[3]	Dn[2]	Dn[1]	Dn[0]	
Description	<p>This command transfers image data from the host processor to the display module's frame memory continuing from the pixel location following the previous write_memory_continue or write_memory_start command.</p> <p>If MV(36h-B5) = 0:</p> <p>Data is written continuing from the pixel location after the write range of the previous RAMWR(2Ch) or RAMWRC(3Ch). The column register is then incremented and pixels are written to the frame memory until the column register equals the End Column (EC) value. The column register is then reset to SC and the page register is incremented. Pixels are written to the frame memory until the page register equals the End Page (EP) value or the host processor sends another command. If the number of pixels exceeds $(EC - SC + 1) * (EP - SP + 1)$ the extra pixels are ignored.</p> <p>If MV(36h-B5) = 1:</p> <p>Data is written continuing from the pixel location after the write range of the previous RAMWR(2Ch) or RAMWRC(3Ch). The page register is then incremented and pixels are written to the frame memory until the page register equals the End Page (EP) value. The page register is then reset to SP and the column register is incremented. Pixels are written to the frame memory until the column register equals the End column (EC) value or the host processor sends another command. If the number of pixels exceeds $(EC - SC + 1) * (EP - SP + 1)$ the extra pixels are ignored.</p> <p>Frame Memory Access and Interface setting (B3h), WEMODE=0</p> <p>When the transfer number of data exceeds $(EC-SC+1)*(EP-SP+1)$, the exceeding data will be ignored.</p>												

	<p>Frame Memory Access and Interface setting (B3h), WEMODE=1</p> <p>When the transfer number of data exceeds $(EC-SC+1)*(EP-SP+1)$, the column and page number will be reset, and the exceeding data will be written into the following column and page.</p>												
Restriction	<p>A Memory Write should follow a CASET(2Ah), RASET(2Bh) or MADCTR(36h) to define the write location. Otherwise, data written with RAMWR(2Ch) and any following RAMWRC(3Ch) commands is written to undefined locations.</p>												
Register Availability	<table border="1"> <thead> <tr> <th>Status</th> <th>Availability</th> </tr> </thead> <tbody> <tr> <td>Normal Mode On, Idle Mode Off, Sleep Out</td> <td>Yes</td> </tr> <tr> <td>Normal Mode On, Idle Mode On, Sleep Out</td> <td>Yes</td> </tr> <tr> <td>Partial Mode On, Idle Mode Off, Sleep Out</td> <td>Yes</td> </tr> <tr> <td>Partial Mode On, Idle Mode On, Sleep Out</td> <td>Yes</td> </tr> <tr> <td>Sleep In</td> <td>Yes</td> </tr> </tbody> </table>	Status	Availability	Normal Mode On, Idle Mode Off, Sleep Out	Yes	Normal Mode On, Idle Mode On, Sleep Out	Yes	Partial Mode On, Idle Mode Off, Sleep Out	Yes	Partial Mode On, Idle Mode On, Sleep Out	Yes	Sleep In	Yes
Status	Availability												
Normal Mode On, Idle Mode Off, Sleep Out	Yes												
Normal Mode On, Idle Mode On, Sleep Out	Yes												
Partial Mode On, Idle Mode Off, Sleep Out	Yes												
Partial Mode On, Idle Mode On, Sleep Out	Yes												
Sleep In	Yes												
Default	<table border="1"> <thead> <tr> <th>Status</th> <th>Default Value</th> </tr> </thead> <tbody> <tr> <td>Power On Sequence</td> <td>Contents of memory is set randomly</td> </tr> <tr> <td>SW Reset</td> <td>Contents of memory is not cleared</td> </tr> <tr> <td>HW Reset</td> <td>Contents of memory is not cleared</td> </tr> </tbody> </table>	Status	Default Value	Power On Sequence	Contents of memory is set randomly	SW Reset	Contents of memory is not cleared	HW Reset	Contents of memory is not cleared				
Status	Default Value												
Power On Sequence	Contents of memory is set randomly												
SW Reset	Contents of memory is not cleared												
HW Reset	Contents of memory is not cleared												
Flow chart	<pre> graph TD A[RAMWRC (3Ch)] --> B([Image Data D1[B:0], D2[B:0], Dn[B:0]]) B --> C[Any Command] </pre> <p>Note : B = 23</p>												

RAMRDC(3E00h) : Read_Memory_Continue

3E00H	Read_Memory_Continue												
	DCX	RDX	WRX	D24-8	D7	D6	D5	D4	D3	D2	D1	D0	HEX
Command	0	1	↑	x	0	0	1	1	1	1	1	0	3E
1 st parameter	1	↑	1	x	x	x	x	x	x	x	x	x	x
2 nd parameter	1	↑	1	D1[24..8]	D1[7]	D1[6]	D1[5]	D1[4]	D1[3]	D1[2]	D1[1]	D1[0]	
X st parameter	1	↑	1	Dx[24..8]	Dx[7]	Dx[6]	Dx[5]	Dx[4]	Dx[3]	Dx[2]	Dx[1]	Dx[0]	
N st parameter	1	↑	1	Dn[24..8]	Dn[7]	Dn[6]	Dn[5]	Dn[4]	Dn[3]	Dn[2]	Dn[1]	Dn[0]	
Description	<p>This command transfers image data from the display module's frame memory to the host processor continuing from the location following the previous read_memory_continue or read_memory_start command.</p> <p>If MV(36h-B5) = 0: Pixels are read continuing from the pixel location after the read range of the previous RAMWR(2Ch) or RAMWRC(3Ch). The column register is then incremented and pixels are read from the frame memory until the column register equals the End Column (EC) value. The column register is then reset to SC and the page register is incremented. Pixels are read from the frame memory until the page register equals the End Page (EP) value or the host processor sends another command.</p> <p>If MV(36h-B5) B5 = 1: Pixels are read continuing from the pixel location after the read range of the previous RAMWR(2Ch) or RAMWRC(3Ch). The page register is then incremented and pixels are read from the frame memory until the page register equals the End Page (EP) value. The page register is then reset to SP and the column register is incremented. Pixels are read from the frame memory until the column register equals the End Column (EC) value or the host processor sends another command.</p>												
Restriction	<p>A Memory Read should follow a CASET(2Ah), RASET(2Bh) or MADCTR(36h) to define the write location. Otherwise, data written with RAMRD(2Eh) and any following RAMRDC(3Eh) commands is written to undefined locations.</p>												

<p>Register Availability</p>	<table border="1"> <thead> <tr> <th>Status</th> <th>Availability</th> </tr> </thead> <tbody> <tr> <td>Normal Mode On, Idle Mode Off, Sleep Out</td> <td>Yes</td> </tr> <tr> <td>Normal Mode On, Idle Mode On, Sleep Out</td> <td>Yes</td> </tr> <tr> <td>Partial Mode On, Idle Mode Off, Sleep Out</td> <td>Yes</td> </tr> <tr> <td>Partial Mode On, Idle Mode On, Sleep Out</td> <td>Yes</td> </tr> <tr> <td>Sleep In</td> <td>Yes</td> </tr> </tbody> </table>	Status	Availability	Normal Mode On, Idle Mode Off, Sleep Out	Yes	Normal Mode On, Idle Mode On, Sleep Out	Yes	Partial Mode On, Idle Mode Off, Sleep Out	Yes	Partial Mode On, Idle Mode On, Sleep Out	Yes	Sleep In	Yes
Status	Availability												
Normal Mode On, Idle Mode Off, Sleep Out	Yes												
Normal Mode On, Idle Mode On, Sleep Out	Yes												
Partial Mode On, Idle Mode Off, Sleep Out	Yes												
Partial Mode On, Idle Mode On, Sleep Out	Yes												
Sleep In	Yes												
<p>Default</p>	<table border="1"> <thead> <tr> <th>Status</th> <th>Default Value</th> </tr> </thead> <tbody> <tr> <td>Power On Sequence</td> <td>Contents of memory is set randomly</td> </tr> <tr> <td>SW Reset</td> <td>Contents of memory is not cleared</td> </tr> <tr> <td>HW Reset</td> <td>Contents of memory is not cleared</td> </tr> </tbody> </table>	Status	Default Value	Power On Sequence	Contents of memory is set randomly	SW Reset	Contents of memory is not cleared	HW Reset	Contents of memory is not cleared				
Status	Default Value												
Power On Sequence	Contents of memory is set randomly												
SW Reset	Contents of memory is not cleared												
HW Reset	Contents of memory is not cleared												
<p>Flow chart</p>	<pre> graph TD A[RAMRDC (3Eh)] --> B[/Dummy Read/] B --> C([Image Data D1[B:0], D2[B:0], ..., Dn[B:0]]) C --> D[Any Command] </pre> <p>Note : B=23</p> <div style="border: 1px dashed black; padding: 5px;"> <p>Legend</p> <ul style="list-style-type: none"> Command Parameter Display Action Mode Sequential transfer </div>												

STESL(4400h) : Set_Tear_Scanline

4400H	STESL(Set_Tear_Scanline)																								
	DCX	RDX	WRX	D15-8	D7	D6	D5	D4	D3	D2	D1	D0	HEX												
Command	0	1	↑	x	0	1	0	0	0	1	0	0	44												
1 st parameter	1	1	↑	xx	0	0	0	0	0	0	0	STS[8]	00												
2 nd parameter	1	1	↑	xx	STS[7]	STS[6]	STS[5]	STS[4]	STS[3]	STS[2]	STS[1]	STS[0]	00												
Description	<p>This command turns on the display Tearing Effect output signal on the TE signal line when the display reaches line N. The TE signal is not affected by changing set_address_mode bit B4. The Tearing Effect Line On has one parameter that describes the Tearing Effect Output Line mode.</p>  <p>The Tearing Effect Output line shall be active low when the display module is in Sleep mode.</p>																								
Restriction																									
Register Availability	<table border="1"> <thead> <tr> <th>Status</th> <th>Availability</th> </tr> </thead> <tbody> <tr> <td>Normal Mode On, Idle Mode Off, Sleep Out</td> <td>Yes</td> </tr> <tr> <td>Normal Mode On, Idle Mode On, Sleep Out</td> <td>Yes</td> </tr> <tr> <td>Partial Mode On, Idle Mode Off, Sleep Out</td> <td>Yes</td> </tr> <tr> <td>Partial Mode On, Idle Mode On, Sleep Out</td> <td>Yes</td> </tr> <tr> <td>Sleep In</td> <td>Yes</td> </tr> </tbody> </table>													Status	Availability	Normal Mode On, Idle Mode Off, Sleep Out	Yes	Normal Mode On, Idle Mode On, Sleep Out	Yes	Partial Mode On, Idle Mode Off, Sleep Out	Yes	Partial Mode On, Idle Mode On, Sleep Out	Yes	Sleep In	Yes
Status	Availability																								
Normal Mode On, Idle Mode Off, Sleep Out	Yes																								
Normal Mode On, Idle Mode On, Sleep Out	Yes																								
Partial Mode On, Idle Mode Off, Sleep Out	Yes																								
Partial Mode On, Idle Mode On, Sleep Out	Yes																								
Sleep In	Yes																								
Default	<table border="1"> <thead> <tr> <th>Status</th> <th>Default Value</th> </tr> </thead> <tbody> <tr> <td>Power On Sequence</td> <td>STS[8:0]=9'h000</td> </tr> <tr> <td>SW Reset</td> <td>No change</td> </tr> <tr> <td>HW Reset</td> <td>STS[8:0]=9'h000</td> </tr> </tbody> </table>													Status	Default Value	Power On Sequence	STS[8:0]=9'h000	SW Reset	No change	HW Reset	STS[8:0]=9'h000				
Status	Default Value																								
Power On Sequence	STS[8:0]=9'h000																								
SW Reset	No change																								
HW Reset	STS[8:0]=9'h000																								

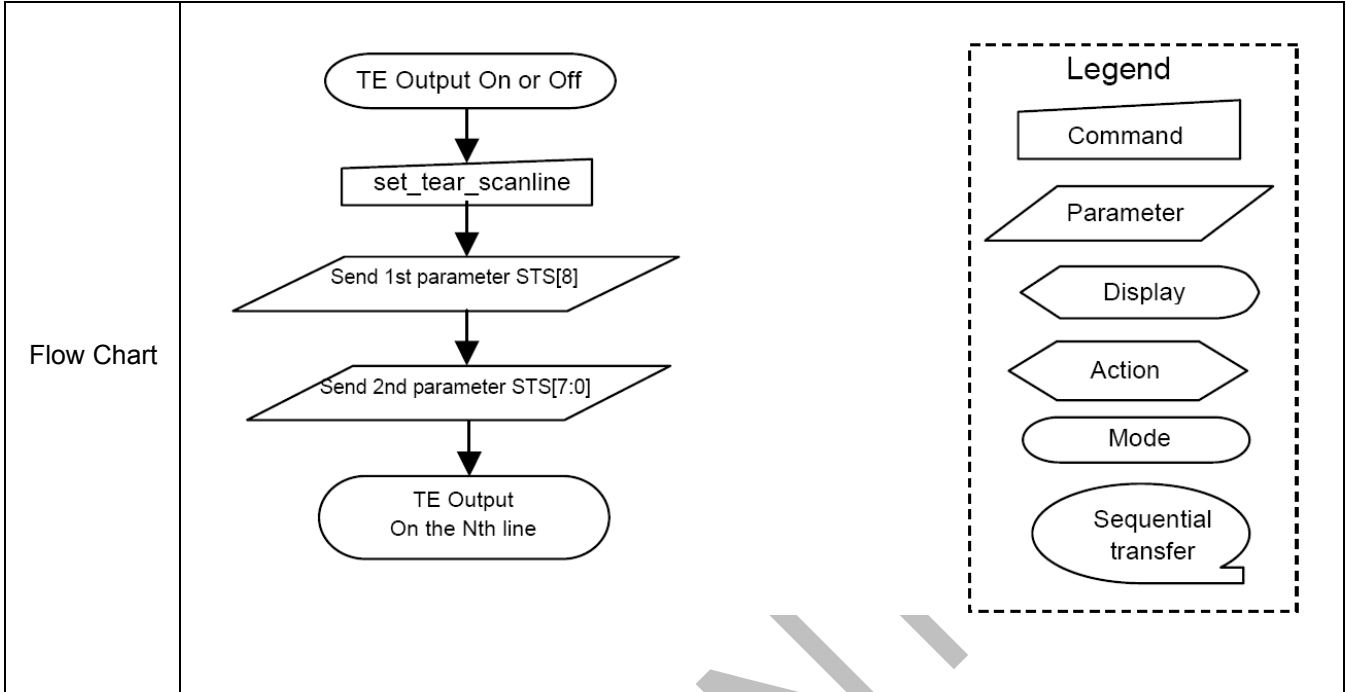

CONFIDENTIAL

GSL (4500h) : Get_Scanline

4500H	GSL(Get_Scanline)																								
	DCX	RDX	WRX	D15-8	D7	D6	D5	D4	D3	D2	D1	D0	HEX												
Command	0	1	↑	x	0	1	0	0	0	1	0	1	45												
1 st parameter	1	↑	1	x	x	x	x	x	x	x	x	x	x												
2 nd parameter	1	↑	1	xx	0	0	0	0	0	0	0	GTS[8]	0x												
3 rd parameter	1	↑	1	xx	GTS[7]	GTS[6]	GTS[5]	GTS[4]	GTS[3]	GTS[2]	GTS[1]	GTS[0]	xx												
Description	<p>The display returns the current scan line, N, used to update the display device. The total number of scan lines on a display device is defined as VSYNC + VBP + VACT + VFP. The first scan line is defined as the first line of V-Sync and is denoted as Line 0.</p> <p>When in Sleep Mode, the value returned by get_scanline is undefined.</p>																								
Restriction	-																								
Register Availability	<table border="1"> <thead> <tr> <th>Status</th> <th>Availability</th> </tr> </thead> <tbody> <tr> <td>Normal Mode On, Idle Mode Off, Sleep Out</td> <td>Yes</td> </tr> <tr> <td>Normal Mode On, Idle Mode On, Sleep Out</td> <td>Yes</td> </tr> <tr> <td>Partial Mode On, Idle Mode Off, Sleep Out</td> <td>Yes</td> </tr> <tr> <td>Partial Mode On, Idle Mode On, Sleep Out</td> <td>Yes</td> </tr> <tr> <td>Sleep In</td> <td>Yes</td> </tr> </tbody> </table>													Status	Availability	Normal Mode On, Idle Mode Off, Sleep Out	Yes	Normal Mode On, Idle Mode On, Sleep Out	Yes	Partial Mode On, Idle Mode Off, Sleep Out	Yes	Partial Mode On, Idle Mode On, Sleep Out	Yes	Sleep In	Yes
Status	Availability																								
Normal Mode On, Idle Mode Off, Sleep Out	Yes																								
Normal Mode On, Idle Mode On, Sleep Out	Yes																								
Partial Mode On, Idle Mode Off, Sleep Out	Yes																								
Partial Mode On, Idle Mode On, Sleep Out	Yes																								
Sleep In	Yes																								
Flow Chart	<pre> graph TD A[get_scanline] --> B{Wait 3us} B --> C[/Dummy Read/] C --> D[/Send 1st parameter GTS[9:8]/] D --> E[/Send 2nd parameter GTS[7:0]/] </pre>																								

DSTBON (4F00h): Deep Standby Mode On

4F00H	DSTBON(Deep Standby Mode On)																								
	DCX	RDX	WRX	D15-8	D7	D6	D5	D4	D3	D2	D1	D0	HEX												
Command	0	1	↑	x	0	1	0	0	1	1	1	1	4F												
1 st parameter	1	1	↑	x	0	0	0	0	0	0	0	DSTB	00												
Description	<p>This command is used to enter deep standby mode.</p> <p>DSTB="1", enter deep standby mode.</p> <p>Notes:</p> <p>1. To exit Deep Standby Mode, input low pulse more than 3 msec to pin RESX.</p>																								
Restriction	There is no visible effect until the Frame Memory is written to.																								
Register Availability	<table border="1"> <thead> <tr> <th>Status</th> <th>Availability</th> </tr> </thead> <tbody> <tr> <td>Normal Mode On, Idle Mode Off, Sleep Out</td> <td>Yes</td> </tr> <tr> <td>Normal Mode On, Idle Mode On, Sleep Out</td> <td>Yes</td> </tr> <tr> <td>Partial Mode On, Idle Mode Off, Sleep Out</td> <td>Yes</td> </tr> <tr> <td>Partial Mode On, Idle Mode On, Sleep Out</td> <td>Yes</td> </tr> <tr> <td>Sleep In</td> <td>Yes</td> </tr> </tbody> </table>													Status	Availability	Normal Mode On, Idle Mode Off, Sleep Out	Yes	Normal Mode On, Idle Mode On, Sleep Out	Yes	Partial Mode On, Idle Mode Off, Sleep Out	Yes	Partial Mode On, Idle Mode On, Sleep Out	Yes	Sleep In	Yes
Status	Availability																								
Normal Mode On, Idle Mode Off, Sleep Out	Yes																								
Normal Mode On, Idle Mode On, Sleep Out	Yes																								
Partial Mode On, Idle Mode Off, Sleep Out	Yes																								
Partial Mode On, Idle Mode On, Sleep Out	Yes																								
Sleep In	Yes																								
Default	<table border="1"> <thead> <tr> <th>Status</th> <th>Default Value</th> </tr> </thead> <tbody> <tr> <td>Power On Sequence</td> <td>00h</td> </tr> <tr> <td>SW Reset</td> <td>00h</td> </tr> <tr> <td>HW Reset</td> <td>00h</td> </tr> </tbody> </table>													Status	Default Value	Power On Sequence	00h	SW Reset	00h	HW Reset	00h				
Status	Default Value																								
Power On Sequence	00h																								
SW Reset	00h																								
HW Reset	00h																								
Flow chart	<pre> graph TD A[DSTBON (4Fh)] --> B[/Parameter DSTB=1/] B --> C([Deep Standby Mode]) </pre> <p>Legend:</p> <ul style="list-style-type: none"> Command: Rectangle Parameter: Parallelogram Display: Oval Action: Arrow Mode: Rounded Rectangle Sequential transfer: Dashed line 																								

WRPFD(50h) : Write Profile Value for Display

50H	WRPFD																								
	DCX	RDX	WRX	D15-8	D7	D6	D5	D4	D3	D2	D1	D0	HEX												
Command	0	1	↑	X	0	1	0	1	0	0	0	0	50												
1 st parameter	1	↑	1	X	x	x	x	x	x	x	x	x	x												
2 nd parameter	1	↑	1	xx	V017	V016	V015	V014	V013	V012	V011	V010	FF												
3 rd parameter	1	↑	1	xx	V027	V026	V025	V024	V023	V022	V021	V020	FF												
n th parameter	1	↑	1	xx	:	:	:	:	:	:	:	:	:												
15 th parameter	1	↑	1	xx	V157	V156	V155	V154	V153	V152	V151	V150	FF												
16 th parameter	1	↑	1	xx	V167	V166	V165	V164	V163	V162	V161	V160	FF												
Description	This command is used to define profile values for display.																								
Restriction	-																								
Register Availability	<table border="1"> <thead> <tr> <th>Status</th> <th>Availability</th> </tr> </thead> <tbody> <tr> <td>Normal Mode On, Idle Mode Off, Sleep Out</td> <td>Yes</td> </tr> <tr> <td>Normal Mode On, Idle Mode On, Sleep Out</td> <td>Yes</td> </tr> <tr> <td>Partial Mode On, Idle Mode Off, Sleep Out</td> <td>Yes</td> </tr> <tr> <td>Partial Mode On, Idle Mode On, Sleep Out</td> <td>Yes</td> </tr> <tr> <td>Sleep In</td> <td>Yes</td> </tr> </tbody> </table>													Status	Availability	Normal Mode On, Idle Mode Off, Sleep Out	Yes	Normal Mode On, Idle Mode On, Sleep Out	Yes	Partial Mode On, Idle Mode Off, Sleep Out	Yes	Partial Mode On, Idle Mode On, Sleep Out	Yes	Sleep In	Yes
Status	Availability																								
Normal Mode On, Idle Mode Off, Sleep Out	Yes																								
Normal Mode On, Idle Mode On, Sleep Out	Yes																								
Partial Mode On, Idle Mode Off, Sleep Out	Yes																								
Partial Mode On, Idle Mode On, Sleep Out	Yes																								
Sleep In	Yes																								
Default	<table border="1"> <thead> <tr> <th>Status</th> <th>Default Value</th> </tr> </thead> <tbody> <tr> <td>Power On Sequence</td> <td>FFh</td> </tr> <tr> <td>SW Reset</td> <td>FFh</td> </tr> <tr> <td>HW Reset</td> <td>FFh</td> </tr> </tbody> </table>													Status	Default Value	Power On Sequence	FFh	SW Reset	FFh	HW Reset	FFh				
Status	Default Value																								
Power On Sequence	FFh																								
SW Reset	FFh																								
HW Reset	FFh																								

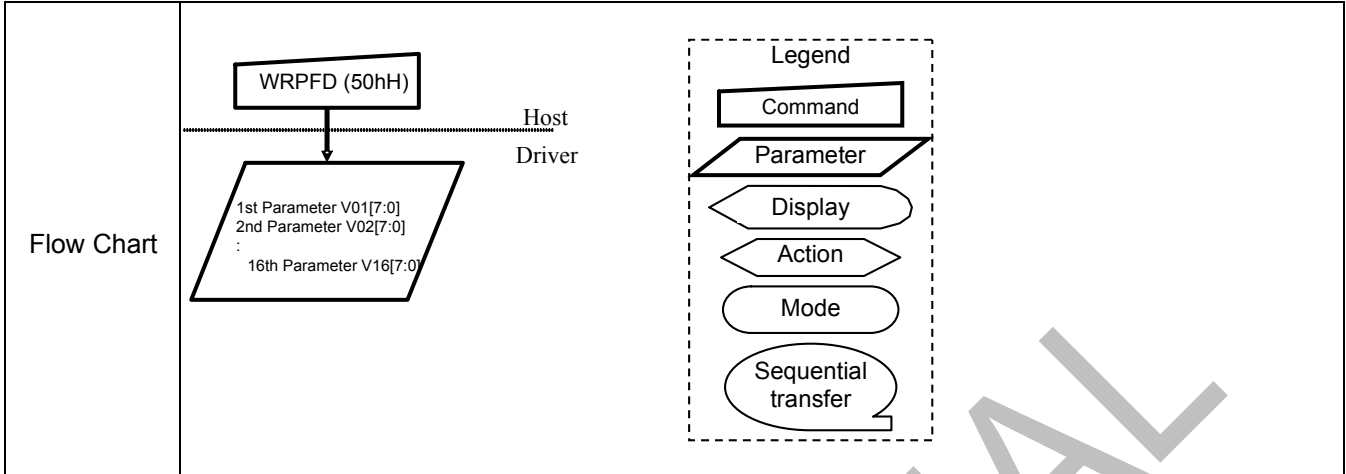

CONFIDENTIAL

WRDISBV (5100h): Write Display Brightness

5100H	WRDISBV																							
	DCX	RDX	WRX	D15-8	D7	D6	D5	D4	D3	D2	D1	D0	HEX											
Command	0	1	↑	x	0	1	0	1	0	0	0	1	51											
1 st parameter	1	1	↑	x	DBV7	DBV6	DBV5	DBV4	DBV3	DBV2	DBV1	DBV0	00											
Description	<p>This command is used to adjust brightness value.</p> <p>In principle relationship is that 00h value means the lowest brightness and FFh value means the highest brightness.</p>																							
	DBV[7:0]				Brightness (ratio)				Brightness (%)															
	00h				0/256				0%															
	01h				2/256				0.78125%															
	:				:				:															
	FEh				255/256				99.609375%															
	FFh				256/256				100%															
Restriction	The display supplier cannot use this command for tuning																							
Register Availability	<table border="1"> <thead> <tr> <th>Status</th> <th>Availability</th> </tr> </thead> <tbody> <tr> <td>Normal Mode On, Idle Mode Off, Sleep Out</td> <td>Yes</td> </tr> <tr> <td>Normal Mode On, Idle Mode On, Sleep Out</td> <td>Yes</td> </tr> <tr> <td>Partial Mode On, Idle Mode Off, Sleep Out</td> <td>Yes</td> </tr> <tr> <td>Partial Mode On, Idle Mode On, Sleep Out</td> <td>Yes</td> </tr> <tr> <td>Sleep In</td> <td>Yes</td> </tr> </tbody> </table>												Status	Availability	Normal Mode On, Idle Mode Off, Sleep Out	Yes	Normal Mode On, Idle Mode On, Sleep Out	Yes	Partial Mode On, Idle Mode Off, Sleep Out	Yes	Partial Mode On, Idle Mode On, Sleep Out	Yes	Sleep In	Yes
	Status	Availability																						
	Normal Mode On, Idle Mode Off, Sleep Out	Yes																						
	Normal Mode On, Idle Mode On, Sleep Out	Yes																						
	Partial Mode On, Idle Mode Off, Sleep Out	Yes																						
	Partial Mode On, Idle Mode On, Sleep Out	Yes																						
Sleep In	Yes																							
Default	<table border="1"> <thead> <tr> <th>Status</th> <th>Default Value</th> </tr> </thead> <tbody> <tr> <td>Power On Sequence</td> <td>00h</td> </tr> <tr> <td>SW Reset</td> <td>00h</td> </tr> <tr> <td>HW Reset</td> <td>00h</td> </tr> </tbody> </table>												Status	Default Value	Power On Sequence	00h	SW Reset	00h	HW Reset	00h				
	Status	Default Value																						
	Power On Sequence	00h																						
	SW Reset	00h																						
HW Reset	00h																							

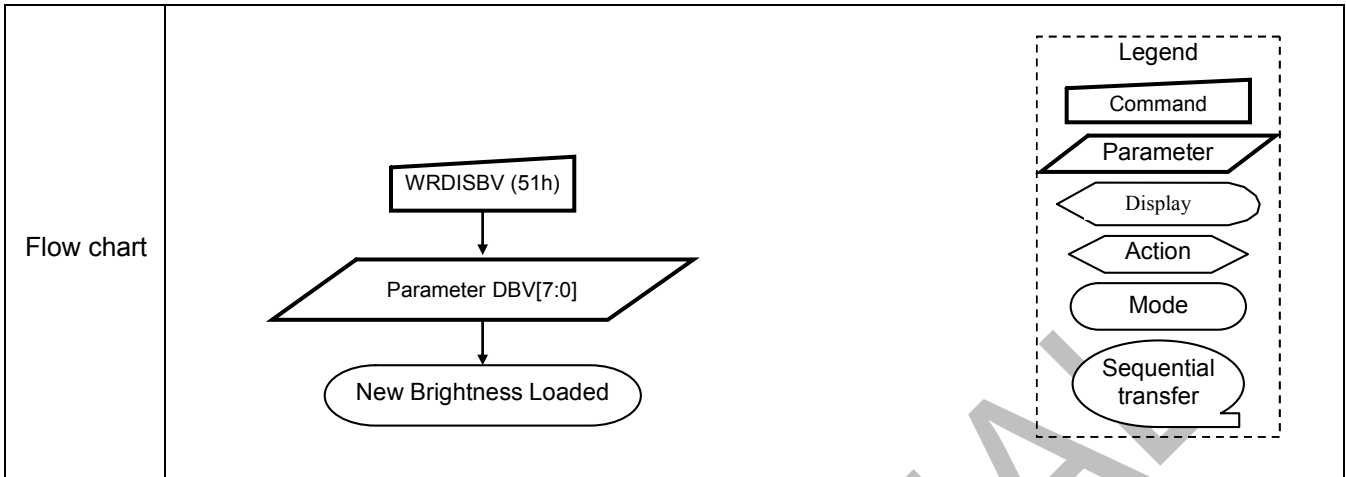

CONFIDENTIAL

RDDISBV (5200h): Read Display Brightness

5200H	RDDISBV																								
	DCX	RDX	WRX	D15-8	D7	D6	D5	D4	D3	D2	D1	D0	HEX												
Command	0	1	↑	x	0	1	0	1	0	0	1	0	52												
1 st parameter	1	↑	1	x	x	x	x	x	x	x	x	x	X												
2 nd parameter	1	↑	1	x	DBV7	DBV6	DBV5	DBV4	DBV3	DBV2	DBV1	DBV0	00												
Description	This command returns brightness value. In principle relationship is that 00h value means the lowest brightness and FFh value means the highest brightness.																								
Restriction	-																								
Register Availability	<table border="1"> <thead> <tr> <th>Status</th> <th>Availability</th> </tr> </thead> <tbody> <tr> <td>Normal Mode On, Idle Mode Off, Sleep Out</td> <td>Yes</td> </tr> <tr> <td>Normal Mode On, Idle Mode On, Sleep Out</td> <td>Yes</td> </tr> <tr> <td>Partial Mode On, Idle Mode Off, Sleep Out</td> <td>Yes</td> </tr> <tr> <td>Partial Mode On, Idle Mode On, Sleep Out</td> <td>Yes</td> </tr> <tr> <td>Sleep In</td> <td>Yes</td> </tr> </tbody> </table>													Status	Availability	Normal Mode On, Idle Mode Off, Sleep Out	Yes	Normal Mode On, Idle Mode On, Sleep Out	Yes	Partial Mode On, Idle Mode Off, Sleep Out	Yes	Partial Mode On, Idle Mode On, Sleep Out	Yes	Sleep In	Yes
Status	Availability																								
Normal Mode On, Idle Mode Off, Sleep Out	Yes																								
Normal Mode On, Idle Mode On, Sleep Out	Yes																								
Partial Mode On, Idle Mode Off, Sleep Out	Yes																								
Partial Mode On, Idle Mode On, Sleep Out	Yes																								
Sleep In	Yes																								
Default	<table border="1"> <thead> <tr> <th>Status</th> <th>Default Value</th> </tr> </thead> <tbody> <tr> <td>Power On Sequence</td> <td>00h</td> </tr> <tr> <td>SW Reset</td> <td>00h</td> </tr> <tr> <td>HW Reset</td> <td>00h</td> </tr> </tbody> </table>													Status	Default Value	Power On Sequence	00h	SW Reset	00h	HW Reset	00h				
Status	Default Value																								
Power On Sequence	00h																								
SW Reset	00h																								
HW Reset	00h																								
Flow Chart	<pre> graph TD HD[Host Driver] -- Command RDDDISBV (52hH) --> Device Device -- Parameter Send parameter DBV[7:0] --> HD </pre>																								

WRCTRLD (5300h): Write CTRL Display

5300H	WRCTRLD												
	DCX	RDX	WRX	D15-8	D7	D6	D5	D4	D3	D2	D1	D0	HEX
Command	0	1	↑	x	0	1	0	1	0	0	1	1	53
1 st parameter	1	1	↑	x	0	0	BCTRL	A	DD	BL	DB	G	00

CONFIDENTIAL

Description	<p>This command is used to control ambient light, brightness and gamma setting.</p> <p>BCTRL: Brightness Control Block On/Off</p> <p>The BCTRL bit is always used to switch brightness for display with dimming effect (according to DD bit).</p>	
	BCTRL	DESCRIPTION LEDPWM Pin
	0	Off, DBV[7:0] and KBV[7:0] are 00h.
	1	On, DBV[7:0] and KBV[7:0] are active
	<p>A: LABC Block On/Off</p> <p>The BCTRL bit is used to control LABC block.</p>	
	A	DESCRIPTION
	0	Off
	1	On
	<p>DD: Display Dimming Control On/Off</p>	
	DD	DESCRIPTION
	0	Display dimming is off
	1	Display dimming is on
	<p>BL: Backlight Control On/Off without Dimming Effect</p> <p>When BL bit change from "On" to "Off", display brightness is turned off without gradual dimming, even if dimming on (DD="1") is selected.</p>	
	BL	DESCRIPTION
	0	Off
	1	On
	<p>DB: Display Brightness Manual/Automatic</p>	
	DB	DESCRIPTION
	0	Manual, the user has to use this setting for manual adjustment of the brightness to have an effect.
	1	Automatic, information about the used brightness is included in the active profile.
	<p><i>Note: All read and write commands are valid, but there is no effect (except registers can be changed) when write commands are used.</i></p>	
	<p>G: Gamma Curve Manual/Automatic</p>	
	G	DESCRIPTION
0	Manual, by GAMSET-command	
1	Automatic, information about the used gamma is included in the active profile.	
<p>The <i>dimming</i> function is adapted to the brightness registers for display when bit BCTRL is changed at DD="1", e.g. BCTRL: 0→1 or 1→0.</p> <p>When the ambient light sensing off-mode (A="0"), display brightness and gamma setting should be manual setting (DB="0" and G="0"). Setting values are the last one written with "Write Display Brightness (5100h)" command and GAMSET-command or the default one.</p> <p>When the ambient light control on, light sensor control block is always working, even if backlight off (BL="0") and display brightness manual (DB="0") are selected.</p>		

Restriction	The display supplier cannot use this command for tuning												
Register Availability	<table border="1"> <thead> <tr> <th>Status</th> <th>Availability</th> </tr> </thead> <tbody> <tr> <td>Normal Mode On, Idle Mode Off, Sleep Out</td> <td>Yes</td> </tr> <tr> <td>Normal Mode On, Idle Mode On, Sleep Out</td> <td>Yes</td> </tr> <tr> <td>Partial Mode On, Idle Mode Off, Sleep Out</td> <td>Yes</td> </tr> <tr> <td>Partial Mode On, Idle Mode On, Sleep Out</td> <td>Yes</td> </tr> <tr> <td>Sleep In</td> <td>Yes</td> </tr> </tbody> </table>	Status	Availability	Normal Mode On, Idle Mode Off, Sleep Out	Yes	Normal Mode On, Idle Mode On, Sleep Out	Yes	Partial Mode On, Idle Mode Off, Sleep Out	Yes	Partial Mode On, Idle Mode On, Sleep Out	Yes	Sleep In	Yes
Status	Availability												
Normal Mode On, Idle Mode Off, Sleep Out	Yes												
Normal Mode On, Idle Mode On, Sleep Out	Yes												
Partial Mode On, Idle Mode Off, Sleep Out	Yes												
Partial Mode On, Idle Mode On, Sleep Out	Yes												
Sleep In	Yes												
Default	<table border="1"> <thead> <tr> <th>Status</th> <th>Default Value</th> </tr> </thead> <tbody> <tr> <td>Power On Sequence</td> <td>00h</td> </tr> <tr> <td>SW Reset</td> <td>00h</td> </tr> <tr> <td>HW Reset</td> <td>00h</td> </tr> </tbody> </table>	Status	Default Value	Power On Sequence	00h	SW Reset	00h	HW Reset	00h				
Status	Default Value												
Power On Sequence	00h												
SW Reset	00h												
HW Reset	00h												
Flow chart	<pre> graph TD A[WRCTRLD (53h)] --> B[/BCTRL, A, DD, BL, DB/] B --> C([New Control Value]) </pre> <p>Legend</p> <ul style="list-style-type: none"> Command Parameter Display Action Mode Sequential transfer 												

RDCTRLD (5400h): Read CTRL Display Value

5400H	RDCTRLD												
	DCX	RDX	WRX	D15-8	D7	D6	D5	D4	D3	D2	D1	D0	HEX
Command	0	1	↑	x	0	1	0	1	0	0	1	1	53
1 st parameter	1	↑	1	x	x	x	x	x	x	x	x	x	X
2 nd parameter	1	↑	1	x	0	0	BCTRL	A	DD	BL	DB	G	00

CONFIDENTIAL

Description	<p>This command is used to control ambient light, brightness and gamma setting.</p> <p>BCTRL: Brightness Control Block On/Off</p> <p>The BCTRL bit is always used to switch brightness for display with dimming effect (according to DD bit).</p>	
	BCTRL	DESCRIPTION LEDPWM Pin
	0	Off, DBV[7:0] and KBV[7:0] are 00h.
	1	On, DBV[7:0] and KBV[7:0] are active
	<p>A: LABC Block On/Off</p> <p>The BCTRL bit is used to control LABC block.</p>	
	A	DESCRIPTION
	0	Off
	1	On
	<p>DD: Display Dimming Control On/Off</p>	
	DD	DESCRIPTION
	0	Display dimming is off
	1	Display dimming is on
	<p>BL: Backlight Control On/Off without Dimming Effect</p> <p>When BL bit change from "On" to "Off", display brightness is turned off without gradual dimming, even if dimming on (DD="1") is selected.</p>	
	BL	DESCRIPTION
	0	Off
	1	On
	<p>DB: Display Brightness Manual/Automatic</p>	
	DB	DESCRIPTION
	0	Manual, the user has to use this setting for manual adjustment of the brightness to have an effect.
	1	Automatic, information about the used brightness is included in the active profile.
	<p><i>Note: All read and write commands are valid, but there is no effect (except registers can be changed) when write commands are used.</i></p>	
	<p>G: Gamma Curve Manual/Automatic</p>	
	G	DESCRIPTION
0	Manual, by GAMSET-command	
1	Automatic, information about the used gamma is included in the active profile.	
<p>The <i>dimming</i> function is adapted to the brightness registers for display when bit BCTRL is changed at DD="1", e.g. BCTRL: 0→1 or 1→0.</p> <p>When the ambient light sensing off-mode (A="0"), display brightness and gamma setting should be manual setting (DB="0" and G="0"). Setting values are the last one written with "Write Display Brightness (5100h)" command and GAMSET-command or the default one.</p> <p>When the ambient light control on, light sensor control block is always working, even if backlight off (BL="0") and display brightness manual (DB="0") are selected.</p>		

Restriction	The display supplier cannot use this command for tuning												
Register Availability	<table border="1"> <thead> <tr> <th>Status</th> <th>Availability</th> </tr> </thead> <tbody> <tr> <td>Normal Mode On, Idle Mode Off, Sleep Out</td> <td>Yes</td> </tr> <tr> <td>Normal Mode On, Idle Mode On, Sleep Out</td> <td>Yes</td> </tr> <tr> <td>Partial Mode On, Idle Mode Off, Sleep Out</td> <td>Yes</td> </tr> <tr> <td>Partial Mode On, Idle Mode On, Sleep Out</td> <td>Yes</td> </tr> <tr> <td>Sleep In</td> <td>Yes</td> </tr> </tbody> </table>	Status	Availability	Normal Mode On, Idle Mode Off, Sleep Out	Yes	Normal Mode On, Idle Mode On, Sleep Out	Yes	Partial Mode On, Idle Mode Off, Sleep Out	Yes	Partial Mode On, Idle Mode On, Sleep Out	Yes	Sleep In	Yes
Status	Availability												
Normal Mode On, Idle Mode Off, Sleep Out	Yes												
Normal Mode On, Idle Mode On, Sleep Out	Yes												
Partial Mode On, Idle Mode Off, Sleep Out	Yes												
Partial Mode On, Idle Mode On, Sleep Out	Yes												
Sleep In	Yes												
Default	<table border="1"> <thead> <tr> <th>Status</th> <th>Default Value</th> </tr> </thead> <tbody> <tr> <td>Power On Sequence</td> <td>00h</td> </tr> <tr> <td>SW Reset</td> <td>00h</td> </tr> <tr> <td>HW Reset</td> <td>00h</td> </tr> </tbody> </table>	Status	Default Value	Power On Sequence	00h	SW Reset	00h	HW Reset	00h				
Status	Default Value												
Power On Sequence	00h												
SW Reset	00h												
HW Reset	00h												
Flow Chart	<p>RDCTRLD (54hH)</p> <p>Host Driver</p> <p>Send parameter BCTRL, A, DD, BL, DB</p> <p>Legend</p> <ul style="list-style-type: none"> Command Parameter Display Action Mode Sequential transfer 												

WRCABC (5500h): Write Content Adaptive Brightness Control

5500H	WRCABC																							
	DCX	RDX	WRX	D15-8	D7	D6	D5	D4	D3	D2	D1	D0	HEX											
Command	0	1	↑	x	0	1	0	1	0	0	0	1	51											
1 st parameter	1	1	↑	x	0	0	0	0	0	0	C1	C0	00											
Description	This command is used to set parameters for image content based adaptive brightness control functionality. There is possible to use 4 different modes for content adaptive image functionality, which are defined on a table below.																							
	C1				C0				Function															
	0				0				Off															
	0				1				UI Mode															
	1				0				Still Mode															
	1				1				Moving Mode															
Restriction	This register is synchronized with V-sync by internal circuit.																							
Register Availability	<table border="1"> <thead> <tr> <th>Status</th> <th>Availability</th> </tr> </thead> <tbody> <tr> <td>Normal Mode On, Idle Mode Off, Sleep Out</td> <td>Yes</td> </tr> <tr> <td>Normal Mode On, Idle Mode On, Sleep Out</td> <td>Yes</td> </tr> <tr> <td>Partial Mode On, Idle Mode Off, Sleep Out</td> <td>Yes</td> </tr> <tr> <td>Partial Mode On, Idle Mode On, Sleep Out</td> <td>Yes</td> </tr> <tr> <td>Sleep In</td> <td>Yes</td> </tr> </tbody> </table>												Status	Availability	Normal Mode On, Idle Mode Off, Sleep Out	Yes	Normal Mode On, Idle Mode On, Sleep Out	Yes	Partial Mode On, Idle Mode Off, Sleep Out	Yes	Partial Mode On, Idle Mode On, Sleep Out	Yes	Sleep In	Yes
	Status	Availability																						
	Normal Mode On, Idle Mode Off, Sleep Out	Yes																						
	Normal Mode On, Idle Mode On, Sleep Out	Yes																						
	Partial Mode On, Idle Mode Off, Sleep Out	Yes																						
	Partial Mode On, Idle Mode On, Sleep Out	Yes																						
Sleep In	Yes																							
Default	<table border="1"> <thead> <tr> <th>Status</th> <th>Default Value</th> </tr> </thead> <tbody> <tr> <td>Power On Sequence</td> <td>00h</td> </tr> <tr> <td>SW Reset</td> <td>00h</td> </tr> <tr> <td>HW Reset</td> <td>00h</td> </tr> </tbody> </table>												Status	Default Value	Power On Sequence	00h	SW Reset	00h	HW Reset	00h				
	Status	Default Value																						
	Power On Sequence	00h																						
	SW Reset	00h																						
HW Reset	00h																							

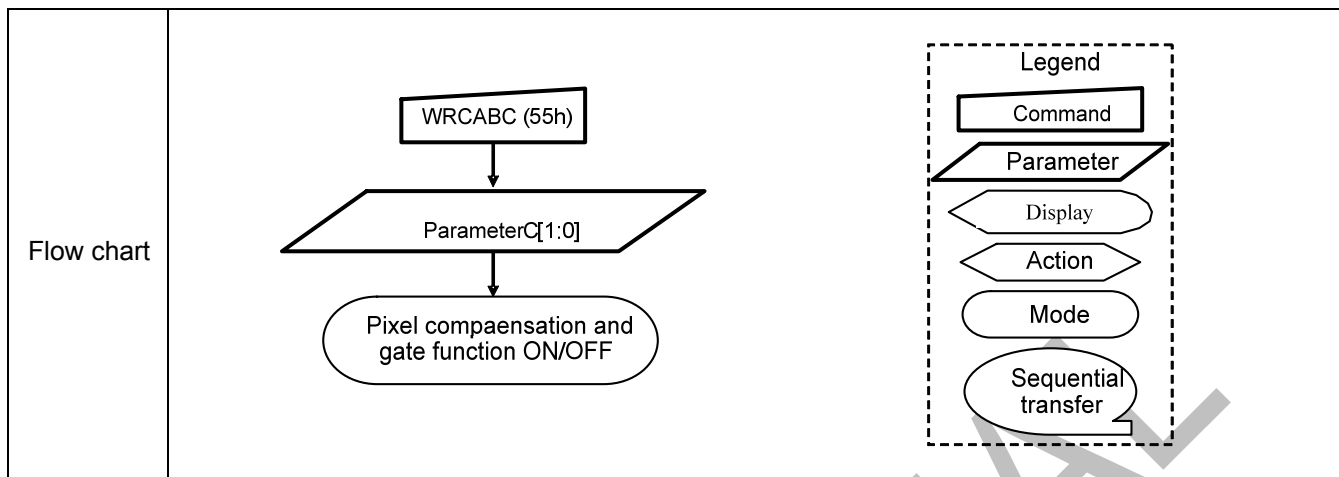

CONFIDENTIAL

RDCABC (5600h): Read Content Adaptive Brightness Control

5600H	RDCABC												HEX														
	DCX	RDX	WRX	D15-8	D7	D6	D5	D4	D3	D2	D1	D0															
Command	0	1	↑	x	0	1	0	1	0	1	1	0	56														
1 st parameter	1	↑	1	x	x	x	x	x	x	x	x	x	X														
2 nd parameter	1	↑	1	x	0	0	0	0	0	0	C1	C0	00														
Description	<p>This command is used to read the settings for image content based adaptive brightness control functionality. There is possible to use 4 different modes for content adaptive image functionality, which are defined on a table below..</p> <table border="1"> <thead> <tr> <th>C1</th> <th>C0</th> <th>Function</th> </tr> </thead> <tbody> <tr> <td>0</td> <td>0</td> <td>Off</td> </tr> <tr> <td>0</td> <td>1</td> <td>UI Mode</td> </tr> <tr> <td>1</td> <td>0</td> <td>Still Mode</td> </tr> <tr> <td>1</td> <td>1</td> <td>Moving Mode</td> </tr> </tbody> </table>												C1	C0	Function	0	0	Off	0	1	UI Mode	1	0	Still Mode	1	1	Moving Mode
C1	C0	Function																									
0	0	Off																									
0	1	UI Mode																									
1	0	Still Mode																									
1	1	Moving Mode																									
Restriction	-																										
Register Availability	<table border="1"> <thead> <tr> <th>Status</th> <th>Availability</th> </tr> </thead> <tbody> <tr> <td>Normal Mode On, Idle Mode Off, Sleep Out</td> <td>Yes</td> </tr> <tr> <td>Normal Mode On, Idle Mode On, Sleep Out</td> <td>Yes</td> </tr> <tr> <td>Partial Mode On, Idle Mode Off, Sleep Out</td> <td>Yes</td> </tr> <tr> <td>Partial Mode On, Idle Mode On, Sleep Out</td> <td>Yes</td> </tr> <tr> <td>Sleep In</td> <td>Yes</td> </tr> </tbody> </table>												Status	Availability	Normal Mode On, Idle Mode Off, Sleep Out	Yes	Normal Mode On, Idle Mode On, Sleep Out	Yes	Partial Mode On, Idle Mode Off, Sleep Out	Yes	Partial Mode On, Idle Mode On, Sleep Out	Yes	Sleep In	Yes			
Status	Availability																										
Normal Mode On, Idle Mode Off, Sleep Out	Yes																										
Normal Mode On, Idle Mode On, Sleep Out	Yes																										
Partial Mode On, Idle Mode Off, Sleep Out	Yes																										
Partial Mode On, Idle Mode On, Sleep Out	Yes																										
Sleep In	Yes																										
Default	<table border="1"> <thead> <tr> <th>Status</th> <th>Default Value</th> </tr> </thead> <tbody> <tr> <td>Power On Sequence</td> <td>00h</td> </tr> <tr> <td>SW Reset</td> <td>00h</td> </tr> <tr> <td>HW Reset</td> <td>00h</td> </tr> </tbody> </table>												Status	Default Value	Power On Sequence	00h	SW Reset	00h	HW Reset	00h							
Status	Default Value																										
Power On Sequence	00h																										
SW Reset	00h																										
HW Reset	00h																										

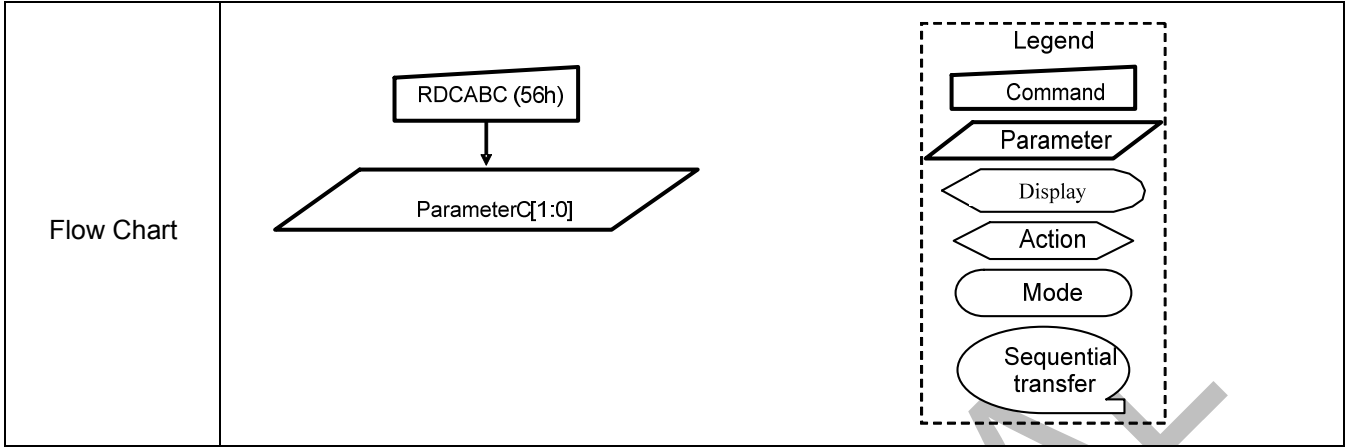

CONFIDENTIAL

WRHYSTE (5700h): Write Hystersis

5700H	WRHYSTE												
	DCX	RDX	WRX	D15-8	D7	D6	D5	D4	D3	D2	D1	D0	HEX
Command	0	1	↑	x	0	1	0	1	0	1	1	1	57
1 st parameter	1	1	↑	x	I0115	I0114	I0113	I0112	I0111	I0110	I0109	I0108	FF
2 nd parameter	1	1	↑	x	I0117	I0116	I0115	I0114	I0113	I0112	I0111	I0110	FF
3 rd parameter	1	1	↑	x	I0215	I0214	I0213	I0212	I0211	I0210	I0209	I0208	FF
4 th parameter	1	1	↑	x	I0217	I0216	I0215	I0214	I0213	I0212	I0211	I0210	FF
:	:	:	:	:	:	:	:	:	:	:	:	:	:
28 rd parameter	1	1	↑	x	I1515	I1514	I1513	I1512	I1511	I1510	I1509	I1508	FF
29 th parameter	1	1	↑	x	I1517	I1516	I1515	I1514	I1513	I1512	I1511	I1510	FF
30 rd parameter	1	1	↑	x	I1615	I1614	I1613	I1612	I1611	I1610	I1609	I1608	FF
31 th parameter	1	1	↑	x	I1617	I1616	I1615	I1614	I1613	I1612	I1611	I1610	FF
32 rd parameter	1	1	↑	x	D0115	D0114	D0113	D0112	D0111	D0110	D0109	D0108	FF
33 th parameter	1	1	↑	x	D0117	D0116	D0115	D0114	D0113	D0112	D0111	D0110	FF
34 rd parameter	1	1	↑	x	D0215	D0214	D0213	D0212	D0211	D0210	D0209	D0208	FF
35 th parameter	1	1	↑	x	D0217	D0216	D0215	D0214	D0213	D0212	D0211	D0210	FF
:	:	:	:	:	:	:	:	:	:	:	:	:	:
60 rd parameter	1	1	↑	x	D1515	D1514	D1513	D1512	D1511	D1510	D1509	D1508	FF
61 th parameter	1	1	↑	x	D1517	D1516	D1515	D1514	D1513	D1512	D1511	D1510	FF
62 rd parameter	1	1	↑	x	D1615	D1614	D1613	D1612	D1611	D1610	D1609	D1608	FF
63 th parameter	1	1	↑	x	D1617	D1616	D1615	D1614	D1613	D1612	D1611	D1610	FF
Description	<p>This command is used to define Hysteresis filter function.</p> <p>I_n[15:0] defines increment values and D_n[15:0] defines decrement values.</p> <p>Don't care about the parameter values after "65535 (FFFFh)".</p> <p>I₁₆[15 : 0] bits and D₁₆[15 : 0] bits are always set to "65535 (FFFFh)" internally, if I₁₅[15 : 0] bits and D₁₅[15 : 0] bit are still valid and less than "65535 (FFFFh)".</p>												
Restriction	-												

Register Availability	<table border="1"> <thead> <tr> <th>Status</th> <th>Availability</th> </tr> </thead> <tbody> <tr> <td>Normal Mode On, Idle Mode Off, Sleep Out</td> <td>Yes</td> </tr> <tr> <td>Normal Mode On, Idle Mode On, Sleep Out</td> <td>Yes</td> </tr> <tr> <td>Partial Mode On, Idle Mode Off, Sleep Out</td> <td>Yes</td> </tr> <tr> <td>Partial Mode On, Idle Mode On, Sleep Out</td> <td>Yes</td> </tr> <tr> <td>Sleep In</td> <td>Yes</td> </tr> </tbody> </table>	Status	Availability	Normal Mode On, Idle Mode Off, Sleep Out	Yes	Normal Mode On, Idle Mode On, Sleep Out	Yes	Partial Mode On, Idle Mode Off, Sleep Out	Yes	Partial Mode On, Idle Mode On, Sleep Out	Yes	Sleep In	Yes
	Status	Availability											
	Normal Mode On, Idle Mode Off, Sleep Out	Yes											
	Normal Mode On, Idle Mode On, Sleep Out	Yes											
	Partial Mode On, Idle Mode Off, Sleep Out	Yes											
	Partial Mode On, Idle Mode On, Sleep Out	Yes											
Sleep In	Yes												
Default	<table border="1"> <thead> <tr> <th>Status</th> <th>Default Value</th> </tr> </thead> <tbody> <tr> <td>Power On Sequence</td> <td>FFh</td> </tr> <tr> <td>SW Reset</td> <td>FFh</td> </tr> <tr> <td>HW Reset</td> <td>FFh</td> </tr> </tbody> </table>	Status	Default Value	Power On Sequence	FFh	SW Reset	FFh	HW Reset	FFh				
	Status	Default Value											
	Power On Sequence	FFh											
	SW Reset	FFh											
HW Reset	FFh												
Flow chart	<pre> graph TD A[WRHYSTE(57h)] --> B["1st Parameter I01[15:8] 2nd Parameter I01[7:0] . 63th Parameter D16[15:8] 64th Parameter D16[7:0]"] </pre>												
	<div style="border: 1px dashed black; padding: 5px;"> <p>Legend</p> <ul style="list-style-type: none"> Command Parameter Display Action Mode Sequential transfer </div>												

WRGAMMASET (5800h): Write Gamma Setting

5800H	WRGAMMASET																							
	DCX	RDX	WRX	D15-8	D7	D6	D5	D4	D3	D2	D1	D0	HEX											
Command	0	1	↑	x	0	1	0	1	1	0	0	0	58											
1 st parameter	1	1	↑	x	G023	G022	G021	G020	G013	G012	G011	G010	01											
2 nd parameter	1	1	↑	x	G043	G042	G041	G040	G033	G032	G031	G030	01											
:	:	:	:	:	:	:	:	:	:	:	:	:	01											
7 rd parameter	1	1	↑	x	G143	G142	G141	G140	G133	G132	G131	G130	01											
8 th parameter	1	1	↑	x	G163	G162	G161	G160	G153	G152	G151	G150	01											
Description	This command is used to define gamma setting values for each luminance level. Gamma value is defined on command "Gamma Set (2600h)".																							
	Gn[3:0]					Parameter					Curve Selected													
	01h					GC0					Gamma Curve 1 (G=2.2)													
	02h					GC1					Reserved													
	04h					GC2					Reserved													
	08h					GC3					Reserved													
Restriction	-																							
Register Availability	<table border="1"> <thead> <tr> <th>Status</th> <th>Availability</th> </tr> </thead> <tbody> <tr> <td>Normal Mode On, Idle Mode Off, Sleep Out</td> <td>Yes</td> </tr> <tr> <td>Normal Mode On, Idle Mode On, Sleep Out</td> <td>Yes</td> </tr> <tr> <td>Partial Mode On, Idle Mode Off, Sleep Out</td> <td>Yes</td> </tr> <tr> <td>Partial Mode On, Idle Mode On, Sleep Out</td> <td>Yes</td> </tr> <tr> <td>Sleep In</td> <td>Yes</td> </tr> </tbody> </table>												Status	Availability	Normal Mode On, Idle Mode Off, Sleep Out	Yes	Normal Mode On, Idle Mode On, Sleep Out	Yes	Partial Mode On, Idle Mode Off, Sleep Out	Yes	Partial Mode On, Idle Mode On, Sleep Out	Yes	Sleep In	Yes
	Status	Availability																						
	Normal Mode On, Idle Mode Off, Sleep Out	Yes																						
	Normal Mode On, Idle Mode On, Sleep Out	Yes																						
	Partial Mode On, Idle Mode Off, Sleep Out	Yes																						
	Partial Mode On, Idle Mode On, Sleep Out	Yes																						
Sleep In	Yes																							
Default	<table border="1"> <thead> <tr> <th>Status</th> <th>Default Value</th> </tr> </thead> <tbody> <tr> <td>Power On Sequence</td> <td>01h</td> </tr> <tr> <td>SW Reset</td> <td>01h</td> </tr> <tr> <td>HW Reset</td> <td>01h</td> </tr> </tbody> </table>												Status	Default Value	Power On Sequence	01h	SW Reset	01h	HW Reset	01h				
	Status	Default Value																						
	Power On Sequence	01h																						
	SW Reset	01h																						
HW Reset	01h																							

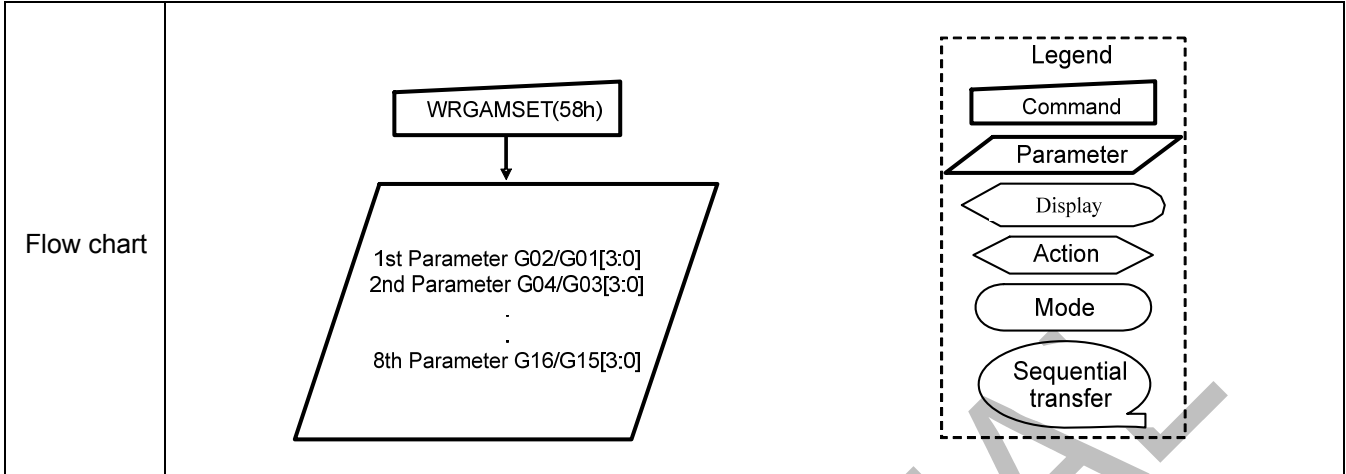

CONFIDENTIAL

RDFSVM (5A00h): Read FS Value MSBs

5A00H	RDFSVM																								
	DCX	RDX	WRX	D15-8	D7	D6	D5	D4	D3	D2	D1	D0	HEX												
Command	0	1	↑	x	0	1	0	1	1	0	1	0	5A												
1 st parameter	1	↑	1	x	x	x	x	x	x	x	x	x	X												
2 nd parameter	1	↑	1	x	FSV15	FSV14	FSV13	FSV12	FSV11	FSV10	FSV9	FSV8	FF												
Description	<p>This command returns MSBs (FSV[15:8]) of the "Front Side Ambient Light Sensor Value" after the flicker has been removed from ambient light reading.</p> <p>Another command for LSBs (FSV[7:0]). See the command "Read FS Value LSBs (5B00h)".</p> <p>When using read LSBs/MSBs command, corresponding MSBs/LSBs should be locked so that they refer to the same value when LSBs/MSBs are read. After reading both values, registers for MSBs and LSBs should be released. And that if e.g. LSBs are read and there is no MSBs read command, the next LSBs read will also update MSBs. If MSBs are read at first, the next MSBs read will update LSBs.</p> <p>If <i>any other</i> commands are received between LSBs read command and MSBs read command, the <i>registers</i> for MSBs and LSBs should be released.</p> <p>FSV[15:8] should be 00h when bit 'A' of the "Write CTRL Display (5300h)" command is "0".</p> <p><i>Note: Although FSV[15:0] is 16-bit length register, the valid value range is 0 ~ 65535 (0000h ~ FFFFh), In other words, user don't care about the parameter values over than "65535 (FFFFh)".</i></p>																								
Restriction	-																								
Register Availability	<table border="1"> <thead> <tr> <th>Status</th> <th>Availability</th> </tr> </thead> <tbody> <tr> <td>Normal Mode On, Idle Mode Off, Sleep Out</td> <td>Yes</td> </tr> <tr> <td>Normal Mode On, Idle Mode On, Sleep Out</td> <td>Yes</td> </tr> <tr> <td>Partial Mode On, Idle Mode Off, Sleep Out</td> <td>Yes</td> </tr> <tr> <td>Partial Mode On, Idle Mode On, Sleep Out</td> <td>Yes</td> </tr> <tr> <td>Sleep In</td> <td>Yes</td> </tr> </tbody> </table>													Status	Availability	Normal Mode On, Idle Mode Off, Sleep Out	Yes	Normal Mode On, Idle Mode On, Sleep Out	Yes	Partial Mode On, Idle Mode Off, Sleep Out	Yes	Partial Mode On, Idle Mode On, Sleep Out	Yes	Sleep In	Yes
Status	Availability																								
Normal Mode On, Idle Mode Off, Sleep Out	Yes																								
Normal Mode On, Idle Mode On, Sleep Out	Yes																								
Partial Mode On, Idle Mode Off, Sleep Out	Yes																								
Partial Mode On, Idle Mode On, Sleep Out	Yes																								
Sleep In	Yes																								

Default	<table border="1"> <thead> <tr> <th>Status</th> <th>Default Value</th> </tr> </thead> <tbody> <tr> <td>Power On Sequence</td> <td>00h</td> </tr> <tr> <td>SW Reset</td> <td>00h</td> </tr> <tr> <td>HW Reset</td> <td>00h</td> </tr> </tbody> </table>	Status	Default Value	Power On Sequence	00h	SW Reset	00h	HW Reset	00h
Status	Default Value								
Power On Sequence	00h								
SW Reset	00h								
HW Reset	00h								
Flow Chart	<pre> graph TD A[RDFSVM(5Ah)] --> B[/Send Parameter FSV[15:8]/] </pre> <p>Legend</p> <ul style="list-style-type: none"> Command: Rectangle Parameter: Parallelogram Display: Oval Action: Arrow Mode: Rounded Rectangle Sequential transfer: Oval with tail 								

CONFIDENTIAL

RDFSVL (5B00h): Read FS Value LSBs

5B00H	RDFSVL																								
	DCX	RDX	WRX	D15-8	D7	D6	D5	D4	D3	D2	D1	D0	HEX												
Command	0	1	↑	x	0	1	0	1	1	0	1	1	5B												
1 st parameter	1	↑	1	x	x	x	x	x	x	x	x	x	X												
2 nd parameter	1	↑	1	x	FSV7	FSV6	FSV5	FSV4	FSV3	FSV2	FSV1	FSV0	FF												
Description	<p>This command returns LSBs (FSV[7:0]) of the "Front Side Ambient Light Sensor Value" after the flicker has been removed from ambient light reading.</p> <p>Another command for MSBs (FSV[15:8]). See the command "Read FS Value MSBs (5A00h)".</p> <p>When using read LSBs/MSBs command, corresponding MSBs/LSBs should be locked so that they refer to the same value when LSBs/MSBs are read. After reading both values, registers for MSBs and LSBs should be released. And that if e.g. LSBs are read and there is no MSBs read command, the next LSBs read will also update MSBs. If MSBs are read at first, the next MSBs read will update LSBs.</p> <p>If any other commands are received between LSBs read command and MSBs read command, the registers for MSBs and LSBs should be released.</p> <p>FSV[7:0] should be 00h when bit 'A' of the "Write CTRL Display (5300h)" command is "0".</p> <p><i>Note: Although FSV[15:0] is 16-bit length register, the valid value range is 0 ~ 65535 (0000h ~ FFFFh), In other words, user don't care about the parameter values over than "65535 (FFFFh)".</i></p>																								
Restriction	-																								
Register Availability	<table border="1"> <thead> <tr> <th>Status</th> <th>Availability</th> </tr> </thead> <tbody> <tr> <td>Normal Mode On, Idle Mode Off, Sleep Out</td> <td>Yes</td> </tr> <tr> <td>Normal Mode On, Idle Mode On, Sleep Out</td> <td>Yes</td> </tr> <tr> <td>Partial Mode On, Idle Mode Off, Sleep Out</td> <td>Yes</td> </tr> <tr> <td>Partial Mode On, Idle Mode On, Sleep Out</td> <td>Yes</td> </tr> <tr> <td>Sleep In</td> <td>Yes</td> </tr> </tbody> </table>													Status	Availability	Normal Mode On, Idle Mode Off, Sleep Out	Yes	Normal Mode On, Idle Mode On, Sleep Out	Yes	Partial Mode On, Idle Mode Off, Sleep Out	Yes	Partial Mode On, Idle Mode On, Sleep Out	Yes	Sleep In	Yes
Status	Availability																								
Normal Mode On, Idle Mode Off, Sleep Out	Yes																								
Normal Mode On, Idle Mode On, Sleep Out	Yes																								
Partial Mode On, Idle Mode Off, Sleep Out	Yes																								
Partial Mode On, Idle Mode On, Sleep Out	Yes																								
Sleep In	Yes																								

<p>Default</p>	<table border="1"> <thead> <tr> <th>Status</th> <th>Default Value</th> </tr> </thead> <tbody> <tr> <td>Power On Sequence</td> <td>00h</td> </tr> <tr> <td>SW Reset</td> <td>00h</td> </tr> <tr> <td>HW Reset</td> <td>00h</td> </tr> </tbody> </table>	Status	Default Value	Power On Sequence	00h	SW Reset	00h	HW Reset	00h
Status	Default Value								
Power On Sequence	00h								
SW Reset	00h								
HW Reset	00h								
<p>Flow Chart</p>	<pre> graph TD A[RDFSVL(5Bh)] --> B[/Send Parameter FSV[7:0]/] </pre> <p>Legend</p> <ul style="list-style-type: none"> Command: Rectangle Parameter: Parallelogram Display: Oval Action: Arrowhead Mode: Rounded Rectangle Sequential transfer: Oval with tail 								

CONFIDENTIAL

RDMFFSVM (5C00h): Read Median Filter FS Value MSBs

5C00H	RDMFFSVM																								
	DCX	RDX	WRX	D15-8	D7	D6	D5	D4	D3	D2	D1	D0	HEX												
Command	0	1	↑	x	0	1	0	1	1	1	0	0	5A												
1 st parameter	1	↑	1	x	x	x	x	x	x	x	x	x	x												
2 nd parameter	1	↑	1	x	FFSV15	FFSV14	FFSV13	FFSV12	FFSV11	FFSV10	FFSV9	FFSV8	FF												
Description	<p>This command returns MSBs (FFSV[15:8]) of the "Front Side Ambient Light Sensor Value" after the median filter.</p> <p>Another command for LSBs (FFSV[7:0]). See the command "Read Median Filter FS Value LSBs (5D00h)".</p> <p>When using read LSBs/MSBs command, corresponding MSBs/LSBs should be locked so that they refer to the same value when LSBs/MSBs are read. After reading both values, registers for MSBs and LSBs should be released. And that if e.g. LSBs are read and there is no MSBs read command, the next LSBs read will also update MSBs. If MSBs are read at first, the next MSBs read will update LSBs.</p> <p>If any other commands are received between LSBs read command and MSBs read command, the registers for MSBs and LSBs should be released.</p> <p>FFSV[15:8] should be 00h when bit 'A' of the "Write CTRL Display (5300h)" command is "0".</p> <p><i>Note: Although FFSV[15:0] is 16-bit length register, the valid value range is 0 ~ 65535 (0000h ~ FFFFh), In other words, user don't care about the parameter values over than "65535 (FFFFh)".</i></p>																								
Restriction	-																								
Register Availability	<table border="1"> <thead> <tr> <th>Status</th> <th>Availability</th> </tr> </thead> <tbody> <tr> <td>Normal Mode On, Idle Mode Off, Sleep Out</td> <td>Yes</td> </tr> <tr> <td>Normal Mode On, Idle Mode On, Sleep Out</td> <td>Yes</td> </tr> <tr> <td>Partial Mode On, Idle Mode Off, Sleep Out</td> <td>Yes</td> </tr> <tr> <td>Partial Mode On, Idle Mode On, Sleep Out</td> <td>Yes</td> </tr> <tr> <td>Sleep In</td> <td>Yes</td> </tr> </tbody> </table>													Status	Availability	Normal Mode On, Idle Mode Off, Sleep Out	Yes	Normal Mode On, Idle Mode On, Sleep Out	Yes	Partial Mode On, Idle Mode Off, Sleep Out	Yes	Partial Mode On, Idle Mode On, Sleep Out	Yes	Sleep In	Yes
Status	Availability																								
Normal Mode On, Idle Mode Off, Sleep Out	Yes																								
Normal Mode On, Idle Mode On, Sleep Out	Yes																								
Partial Mode On, Idle Mode Off, Sleep Out	Yes																								
Partial Mode On, Idle Mode On, Sleep Out	Yes																								
Sleep In	Yes																								

<p>Default</p>	<table border="1"> <thead> <tr> <th>Status</th> <th>Default Value</th> </tr> </thead> <tbody> <tr> <td>Power On Sequence</td> <td>00h</td> </tr> <tr> <td>SW Reset</td> <td>00h</td> </tr> <tr> <td>HW Reset</td> <td>00h</td> </tr> </tbody> </table>	Status	Default Value	Power On Sequence	00h	SW Reset	00h	HW Reset	00h
Status	Default Value								
Power On Sequence	00h								
SW Reset	00h								
HW Reset	00h								
<p>Flow Chart</p>	<pre> graph TD A[RDMFFSVM(5Ch)] --> B[/Send Parameter FFSV[15:8]/] </pre> <p>Legend</p> <ul style="list-style-type: none"> Command: Rectangle Parameter: Parallelogram Display: Oval Action: Arrowhead Mode: Capsule Sequential transfer: Oval with tail 								

CONFIDENTIAL

RDMFFSVL (5D00h): Read Median Filter FS Value LSBs

5D00H	RDMFFSVL																								
	DCX	RDX	WRX	D15-8	D7	D6	D5	D4	D3	D2	D1	D0	HEX												
Command	0	1	↑	x	0	1	0	1	1	1	0	1	5D												
1 st parameter	1	↑	1	x	x	x	x	x	x	x	x	x	x												
2 nd parameter	1	↑	1	x	FFSV7	FFSV6	FFSV5	FFSV4	FFSV3	FFSV2	FFSV1	FFSV0	FF												
Description	<p>This command returns LSBs (FDSV[7:0]) of the "Front Side Ambient Light Sensor Value" after the median filter.</p> <p>Another command for MSBs (FFSV[15:8]). See the command "Read Median Filter FS Value MSBs (5C00h)".</p> <p>When using read LSBs/MSBs command, corresponding MSBs/LSBs should be locked so that they refer to the same value when LSBs/MSBs are read. After reading both values, registers for MSBs and LSBs should be released. And that if e.g. LSBs are read and there is no MSBs read command, the next LSBs read will also update MSBs. If MSBs are read at first, the next MSBs read will update LSBs.</p> <p>If any other commands are received between LSBs read command and MSBs read command, the registers for MSBs and LSBs should be released.</p> <p>FFSV[7:0] should be 00h when bit 'A' of the "Write CTRL Display (5300h)" command is "0".</p> <p><i>Note: Although FSV[15:0] is 16-bit length register, the valid value range is 0 ~ 65535 (0000h ~ FFFFh), In other words, user don't care about the parameter values over than "65535 (FFFFh)".</i></p>																								
Restriction	-																								
Register Availability	<table border="1"> <thead> <tr> <th>Status</th> <th>Availability</th> </tr> </thead> <tbody> <tr> <td>Normal Mode On, Idle Mode Off, Sleep Out</td> <td>Yes</td> </tr> <tr> <td>Normal Mode On, Idle Mode On, Sleep Out</td> <td>Yes</td> </tr> <tr> <td>Partial Mode On, Idle Mode Off, Sleep Out</td> <td>Yes</td> </tr> <tr> <td>Partial Mode On, Idle Mode On, Sleep Out</td> <td>Yes</td> </tr> <tr> <td>Sleep In</td> <td>Yes</td> </tr> </tbody> </table>													Status	Availability	Normal Mode On, Idle Mode Off, Sleep Out	Yes	Normal Mode On, Idle Mode On, Sleep Out	Yes	Partial Mode On, Idle Mode Off, Sleep Out	Yes	Partial Mode On, Idle Mode On, Sleep Out	Yes	Sleep In	Yes
Status	Availability																								
Normal Mode On, Idle Mode Off, Sleep Out	Yes																								
Normal Mode On, Idle Mode On, Sleep Out	Yes																								
Partial Mode On, Idle Mode Off, Sleep Out	Yes																								
Partial Mode On, Idle Mode On, Sleep Out	Yes																								
Sleep In	Yes																								

<p>Default</p>	<table border="1"> <thead> <tr> <th>Status</th> <th>Default Value</th> </tr> </thead> <tbody> <tr> <td>Power On Sequence</td> <td>00h</td> </tr> <tr> <td>SW Reset</td> <td>00h</td> </tr> <tr> <td>HW Reset</td> <td>00h</td> </tr> </tbody> </table>	Status	Default Value	Power On Sequence	00h	SW Reset	00h	HW Reset	00h
Status	Default Value								
Power On Sequence	00h								
SW Reset	00h								
HW Reset	00h								
<p>Flow Chart</p>	<pre> graph TD A[RDMFFSVL(5Dh)] --> B[/Send Parameter FFSV[7:0]/] </pre> <p>Legend</p> <ul style="list-style-type: none"> Command: Rectangle Parameter: Parallelogram Display: Oval Action: Arrow Mode: Rounded Rectangle Sequential transfer: Oval with tail 								

CONFIDENTIAL

WRCABCMB (5E00h): Write CABC Minimum Brightness

5E00H	WRCABCMB																								
	DCX	RDX	WRX	D15-8	D7	D6	D5	D4	D3	D2	D1	D0	HEX												
Command	0	1	↑	x	0	1	0	1	1	1	1	0	5E												
1 st parameter	1	1	↑	x	CMB7	CMB6	CMB5	CMB4	CMB3	CMB2	CMB1	CMB0	00												
Description	<p>This command is used to set the minimum brightness value of the display for CABC function</p> <p>In principle relationship is that 00h value means the lowest brightness for CABC and FFh value means the highest brightness for CABC.</p>																								
Restriction	-																								
Register Availability	<table border="1"> <thead> <tr> <th>Status</th> <th>Availability</th> </tr> </thead> <tbody> <tr> <td>Normal Mode On, Idle Mode Off, Sleep Out</td> <td>Yes</td> </tr> <tr> <td>Normal Mode On, Idle Mode On, Sleep Out</td> <td>Yes</td> </tr> <tr> <td>Partial Mode On, Idle Mode Off, Sleep Out</td> <td>Yes</td> </tr> <tr> <td>Partial Mode On, Idle Mode On, Sleep Out</td> <td>Yes</td> </tr> <tr> <td>Sleep In</td> <td>Yes</td> </tr> </tbody> </table>													Status	Availability	Normal Mode On, Idle Mode Off, Sleep Out	Yes	Normal Mode On, Idle Mode On, Sleep Out	Yes	Partial Mode On, Idle Mode Off, Sleep Out	Yes	Partial Mode On, Idle Mode On, Sleep Out	Yes	Sleep In	Yes
Status	Availability																								
Normal Mode On, Idle Mode Off, Sleep Out	Yes																								
Normal Mode On, Idle Mode On, Sleep Out	Yes																								
Partial Mode On, Idle Mode Off, Sleep Out	Yes																								
Partial Mode On, Idle Mode On, Sleep Out	Yes																								
Sleep In	Yes																								
Default	<table border="1"> <thead> <tr> <th>Status</th> <th>Default Value</th> </tr> </thead> <tbody> <tr> <td>Power On Sequence</td> <td>00h</td> </tr> <tr> <td>SW Reset</td> <td>00h</td> </tr> <tr> <td>HW Reset</td> <td>00h</td> </tr> </tbody> </table>													Status	Default Value	Power On Sequence	00h	SW Reset	00h	HW Reset	00h				
Status	Default Value																								
Power On Sequence	00h																								
SW Reset	00h																								
HW Reset	00h																								
Flow chart	<pre> graph TD A[WRCABCMB(5Eh)] --> B[/Parameter CMB[7:0]/] B --> C([New Display Luminance Value Loaded]) </pre> <p>Legend</p> <ul style="list-style-type: none"> Command: Rectangle Parameter: Parallelogram Display: Oval Action: Arrow Mode: Rounded Rectangle Sequential transfer: Curved Arrow 																								

RDCABCMB (5F00h): Read CABC Minimum Brightness

5F00H	RDCABCMB																								
	DCX	RDX	WRX	D15-8	D7	D6	D5	D4	D3	D2	D1	D0	HEX												
Command	0	1	↑	x	0	1	0	1	1	1	1	1	5F												
1 st parameter	1	1	↑	x	CMB7	CMB6	CMB5	CMB4	CMB3	CMB2	CMB1	CMB0	00												
Description	<p>This command return the minimum brightness value of CABC function</p> <p>In principle relationship is that 00h value means the lowest brightness for CABC and FFh value means the highest brightness for CABC.</p> <p>CMB[7:0] is minimum brightness forCABC specified with “WRCABCMB Write CABC minimum brightness (5Eh)” command.</p>																								
Restriction	-																								
Register Availability	<table border="1"> <thead> <tr> <th>Status</th> <th>Availability</th> </tr> </thead> <tbody> <tr> <td>Normal Mode On, Idle Mode Off, Sleep Out</td> <td>Yes</td> </tr> <tr> <td>Normal Mode On, Idle Mode On, Sleep Out</td> <td>Yes</td> </tr> <tr> <td>Partial Mode On, Idle Mode Off, Sleep Out</td> <td>Yes</td> </tr> <tr> <td>Partial Mode On, Idle Mode On, Sleep Out</td> <td>Yes</td> </tr> <tr> <td>Sleep In</td> <td>Yes</td> </tr> </tbody> </table>													Status	Availability	Normal Mode On, Idle Mode Off, Sleep Out	Yes	Normal Mode On, Idle Mode On, Sleep Out	Yes	Partial Mode On, Idle Mode Off, Sleep Out	Yes	Partial Mode On, Idle Mode On, Sleep Out	Yes	Sleep In	Yes
Status	Availability																								
Normal Mode On, Idle Mode Off, Sleep Out	Yes																								
Normal Mode On, Idle Mode On, Sleep Out	Yes																								
Partial Mode On, Idle Mode Off, Sleep Out	Yes																								
Partial Mode On, Idle Mode On, Sleep Out	Yes																								
Sleep In	Yes																								
Default	<table border="1"> <thead> <tr> <th>Status</th> <th>Default Value</th> </tr> </thead> <tbody> <tr> <td>Power On Sequence</td> <td>00h</td> </tr> <tr> <td>SW Reset</td> <td>00h</td> </tr> <tr> <td>HW Reset</td> <td>00h</td> </tr> </tbody> </table>													Status	Default Value	Power On Sequence	00h	SW Reset	00h	HW Reset	00h				
Status	Default Value																								
Power On Sequence	00h																								
SW Reset	00h																								
HW Reset	00h																								
Flow chart	<pre> graph TD A[RDCABCMB(5Fh)] --> B[/Send Parameter CMB[7:0]/] </pre> <p>Legend</p> <ul style="list-style-type: none"> Command: Rectangle Parameter: Parallelogram Display: Oval Action: Arrowhead Mode: Rounded rectangle Sequential transfer: Dashed line 																								

WRLSCC (6500h): Write Light Sensor Compensation Coefficient Value

6500H	WRLSCC												
	DCX	RDX	WRX	D15-8	D7	D6	D5	D4	D3	D2	D1	D0	HEX
Command	0	1	↑	x	0	1	1	0	0	1	0	1	65
1 st parameter	1	1	↑	x	CC15	CC14	CC13	CC12	CC11	CC10	CC9	CC8	80
2 nd parameter	1	1	↑	x	CC7	CC6	CC5	CC4	CC3	CC2	CC1	CC0	00

Description This command is used to send the compensation coefficient value (CC[15 : 0]).
Default value for compensation coefficient is 1.0 (1000 0000 0000 0000 in binary).

Restriction The display supplier cannot use this command for tuning (e.g. factory tuning, etc.).

Register Availability

Status	Availability
Normal Mode On, Idle Mode Off, Sleep Out	Yes
Normal Mode On, Idle Mode On, Sleep Out	Yes
Partial Mode On, Idle Mode Off, Sleep Out	Yes
Partial Mode On, Idle Mode On, Sleep Out	Yes
Sleep In	Yes

Default

Status	Default Value
Power On Sequence	8000h
SW Reset	8000h
HW Reset	8000h

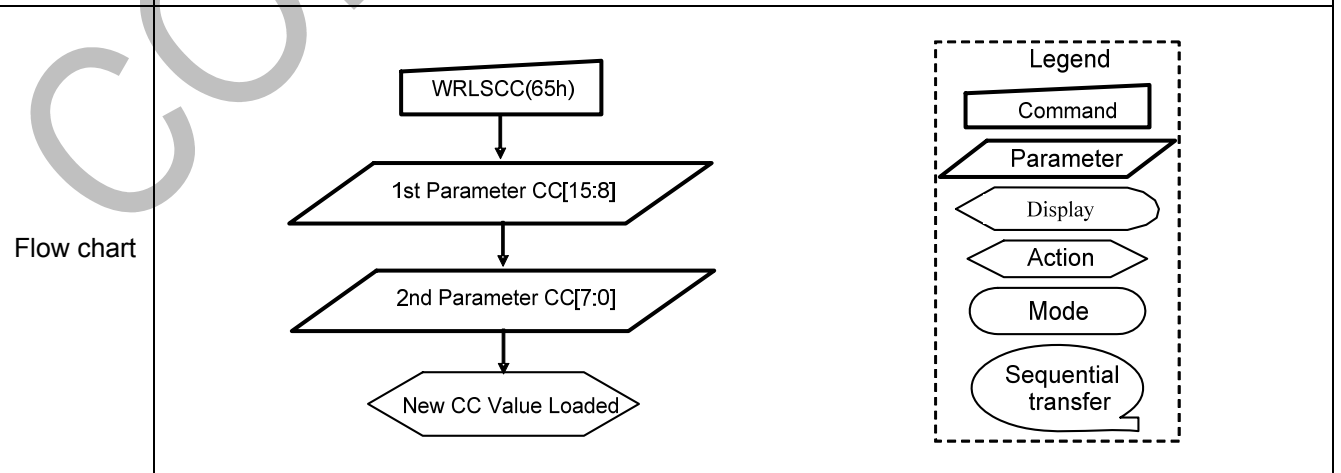

RDLSCCM (6600h): Read Light Sensor Compensation Coefficient Value MSBs

6600H	RDLSCCM																								
	DCX	RDX	WRX	D15-8	D7	D6	D5	D4	D3	D2	D1	D0	HEX												
Command	0	1	↑	x	0	1	1	0	0	1	1	0	66												
1 st parameter	1	↑	1	x	x	x	x	x	x	x	x	x	x												
2 nd parameter	1	↑	1	x	CC15	CC14	CC13	CC12	CC11	CC10	CC9	CC8	80												
Description	<p>This command returns MSBs of the compensation coefficient value (CC[15:8]) which is stored by "Write Light Sensor Compensation Coefficient Value (6500h)" command.</p> <p>It can read MSBs/LSBs of "Light Sensor Compensation Coefficient value" with any order.</p> <p>Default value for compensation coefficient is 1.0 (1000 0000 0000 0000 in binary). MSBs are "1000 000".</p>																								
Restriction	The display supplier cannot use this command for tuning (e.g. factory tuning, etc.).																								
Register Availability	<table border="1"> <thead> <tr> <th>Status</th> <th>Availability</th> </tr> </thead> <tbody> <tr> <td>Normal Mode On, Idle Mode Off, Sleep Out</td> <td>Yes</td> </tr> <tr> <td>Normal Mode On, Idle Mode On, Sleep Out</td> <td>Yes</td> </tr> <tr> <td>Partial Mode On, Idle Mode Off, Sleep Out</td> <td>Yes</td> </tr> <tr> <td>Partial Mode On, Idle Mode On, Sleep Out</td> <td>Yes</td> </tr> <tr> <td>Sleep In</td> <td>Yes</td> </tr> </tbody> </table>													Status	Availability	Normal Mode On, Idle Mode Off, Sleep Out	Yes	Normal Mode On, Idle Mode On, Sleep Out	Yes	Partial Mode On, Idle Mode Off, Sleep Out	Yes	Partial Mode On, Idle Mode On, Sleep Out	Yes	Sleep In	Yes
Status	Availability																								
Normal Mode On, Idle Mode Off, Sleep Out	Yes																								
Normal Mode On, Idle Mode On, Sleep Out	Yes																								
Partial Mode On, Idle Mode Off, Sleep Out	Yes																								
Partial Mode On, Idle Mode On, Sleep Out	Yes																								
Sleep In	Yes																								
Default	<table border="1"> <thead> <tr> <th>Status</th> <th>Default Value</th> </tr> </thead> <tbody> <tr> <td>Power On Sequence</td> <td>80h</td> </tr> <tr> <td>SW Reset</td> <td>80h</td> </tr> <tr> <td>HW Reset</td> <td>80h</td> </tr> </tbody> </table>													Status	Default Value	Power On Sequence	80h	SW Reset	80h	HW Reset	80h				
Status	Default Value																								
Power On Sequence	80h																								
SW Reset	80h																								
HW Reset	80h																								

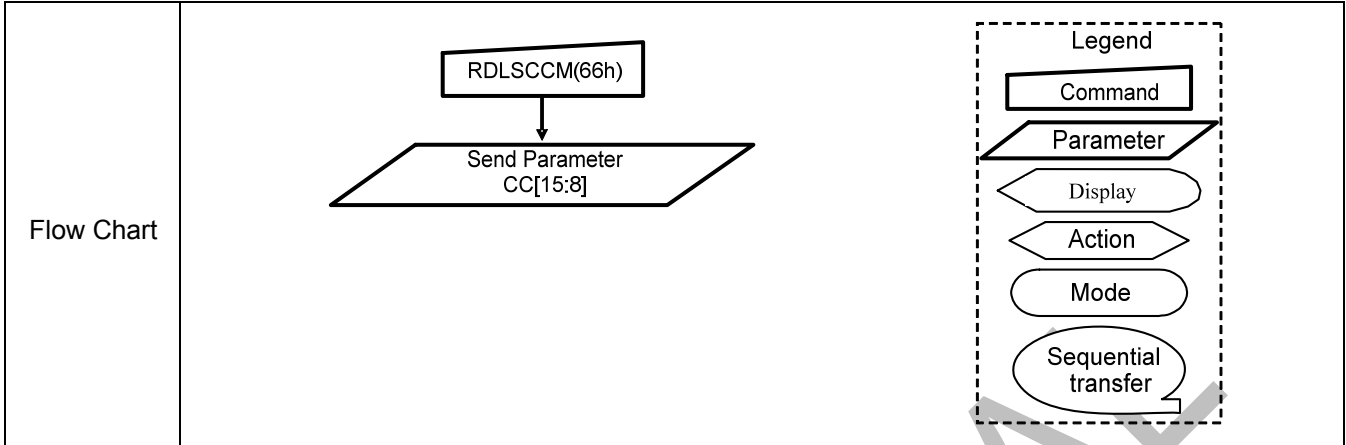

CONFIDENTIAL

RDLSCCL (6700h): Read Light Sensor Compensation Coefficient Value LSBs

6700H	RDLSCCL												
	DCX	RDX	WRX	D15-8	D7	D6	D5	D4	D3	D2	D1	D0	HEX
Command	0	1	↑	x	0	1	1	0	0	1	1	1	67
1 st parameter	1	↑	1	x	x	x	x	x	x	x	x	x	x
2 nd parameter	1	↑	1	x	CC7	CC6	CC5	CC4	CC3	CC2	CC1	CC0	00
Description	<p>This command returns LSBs of the compensation coefficient value (CC[7:0]) which is stored by "Write Light Sensor Compensation Coefficient Value (6501h)" command.</p> <p>It can read MSBs/LSBs of "Light Sensor Compensation Coefficient value" with any order.</p> <p>Default value for compensation coefficient is 1.0 (1000 0000 0000 0000 in binary). MSBs are "0000 000".</p>												
Restriction	The display supplier cannot use this command for tuning (e.g. factory tuning, etc.).												
Register Availability	Status						Availability						
	Normal Mode On, Idle Mode Off, Sleep Out						Yes						
	Normal Mode On, Idle Mode On, Sleep Out						Yes						
	Partial Mode On, Idle Mode Off, Sleep Out						Yes						
	Partial Mode On, Idle Mode On, Sleep Out						Yes						
	Sleep In						Yes						
Default	Status						Default Value						
	Power On Sequence						00h						
	SW Reset						00h						
	HW Reset						00h						

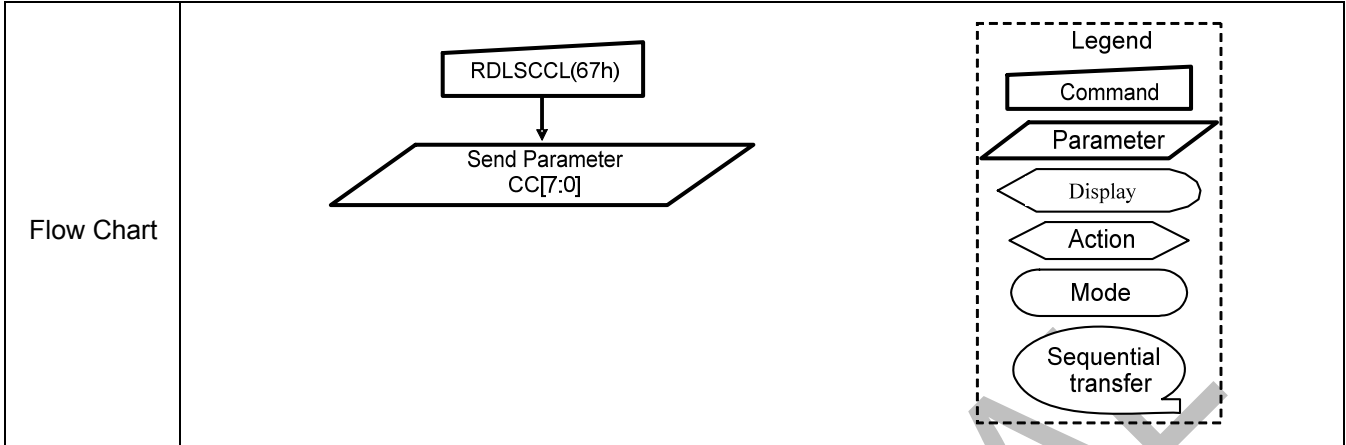

CONFIDENTIAL

RDBWLB (7000h): Read Black/White Low Bits

7000H	RDBWLB												
	DCX	RDX	WRX	D15-8	D7	D6	D5	D4	D3	D2	D1	D0	HEX
Command	0	1	↑	x	0	1	1	1	0	0	0	0	70
1 st parameter	1	↑	1	x	x	x	x	x	x	x	x	x	x
2 nd parameter	1	↑	1	x	Bkx1	Bkx0	Bky1	Bky0	Wx1	Wx0	Wy1	Wy0	00
Description	This command returns the lowest bits of black and white color characteristic. Black: Bkx and Bky White: Wx and Wy												
Restriction	-												
Register Availability	Status						Availability						
	Normal Mode On, Idle Mode Off, Sleep Out						Yes						
	Normal Mode On, Idle Mode On, Sleep Out						Yes						
	Partial Mode On, Idle Mode Off, Sleep Out						Yes						
	Partial Mode On, Idle Mode On, Sleep Out						Yes						
	Sleep In						Yes						
Default	Status						Default Value						
							After MTP	Before MTP					
	Power On Sequence						MTP Value	00h					
	SW Reset						MTP Value	00h					
HW Reset						MTP Value	00h						
Flow Chart	<pre> graph TD A[RDBWLB(70h)] --> B[/Send Parameter Bkx[1:0], Bky[1:0], Wx[1:0], Wy[1:0]/] </pre>												
	<div style="border: 1px dashed black; padding: 5px;"> <p>Legend</p> <ul style="list-style-type: none"> Command Parameter Display Action Mode Sequential transfer </div>												

RDBkx (7100h): Read Bkx

7100H	RDBkx												
	DCX	RDX	WRX	D15-8	D7	D6	D5	D4	D3	D2	D1	D0	HEX
Command	0	1	↑	x	0	1	1	1	0	0	0	1	71
1 st parameter	1	↑	1	x	x	x	x	x	x	x	x	x	x
2 nd parameter	1	↑	1	x	Bkx9	Bkx8	Bkx7	Bkx6	Bkx5	Bkx4	Bkx3	Bkx2	00
Description	This command returns the Bkx bit (Bkx[9:2]) of black color characteristic.												
Restriction	-												
Register Availability	Status						Availability						
	Normal Mode On, Idle Mode Off, Sleep Out						Yes						
	Normal Mode On, Idle Mode On, Sleep Out						Yes						
	Partial Mode On, Idle Mode Off, Sleep Out						Yes						
	Partial Mode On, Idle Mode On, Sleep Out						Yes						
	Sleep In						Yes						
Default	Status						Default Value						
							After MTP			Before MTP			
	Power On Sequence						MTP Value			00h			
	SW Reset						MTP Value			00h			
HW Reset						MTP Value			00h				
Flow Chart	<pre> graph TD A[RDBkx(71h)] --> B[/Send Parameter Bkx[9:2]/] </pre> <p>Legend</p> <ul style="list-style-type: none"> Command: Rectangle Parameter: Parallelogram Display: Pointed rectangle (left) Action: Pointed rectangle (right) Mode: Rounded rectangle Sequential transfer: Oval with tail 												

RDBky (7200h): Read Bky

7200H	RDBky												
	DCX	RDX	WRX	D15-8	D7	D6	D5	D4	D3	D2	D1	D0	HEX
Command	0	1	↑	x	0	1	1	1	0	0	0	1	71
1 st parameter	1	↑	1	x	x	x	x	x	x	x	x	x	x
2 nd parameter	1	↑	1	x	Bky9	Bky8	Bky7	Bky6	Bky5	Bky4	Bky3	Bky2	00
Description	This command returns the Bky bit (Bky[9:2]) of black color characteristic.												
Restriction	-												
Register Availability	Status						Availability						
	Normal Mode On, Idle Mode Off, Sleep Out						Yes						
	Normal Mode On, Idle Mode On, Sleep Out						Yes						
	Partial Mode On, Idle Mode Off, Sleep Out						Yes						
	Partial Mode On, Idle Mode On, Sleep Out						Yes						
	Sleep In						Yes						
Default	Status						Default Value						
							After MTP	Before MTP					
	Power On Sequence						MTP Value	00h					
	SW Reset						MTP Value	00h					
HW Reset						MTP Value	00h						
Flow Chart	<pre> graph TD A[RDBky(72h)] --> B[/Send Parameter Bky[9:2]/] </pre> <p>Legend</p> <ul style="list-style-type: none"> Command: Rectangle Parameter: Parallelogram Display: Pointed rectangle (top-left) Action: Pointed rectangle (top-right) Mode: Rounded rectangle Sequential transfer: Oval with tail 												

RDWx (7300h): Read Wx

7300H	RDWx												
	DCX	RDX	WRX	D15-8	D7	D6	D5	D4	D3	D2	D1	D0	HEX
Command	0	1	↑	x	0	1	1	1	0	0	1	1	73
1 st parameter	1	↑	1	x	x	x	x	x	x	x	x	x	x
2 nd parameter	1	↑	1	x	Wx9	Wx8	Wx7	Wx6	Wx5	Wx4	Wx3	Wx2	00
Description	This command returns the Wx bit (Wx[9:2]) of black color characteristic.												
Restriction	-												
Register Availability	Status						Availability						
	Normal Mode On, Idle Mode Off, Sleep Out						Yes						
	Normal Mode On, Idle Mode On, Sleep Out						Yes						
	Partial Mode On, Idle Mode Off, Sleep Out						Yes						
	Partial Mode On, Idle Mode On, Sleep Out						Yes						
	Sleep In						Yes						
Default	Status						Default Value						
							After MTP	Before MTP					
	Power On Sequence						MTP Value	00h					
	SW Reset						MTP Value	00h					
	HW Reset						MTP Value	00h					
Flow Chart	<pre> graph TD A[RDWx(73h)] --> B[/Send Parameter Wx[9:2]/] </pre> <p>Legend</p> <ul style="list-style-type: none"> Command: Rectangle Parameter: Parallelogram Display: Pointed rectangle (left) Action: Pointed rectangle (right) Mode: Rounded rectangle Sequential transfer: Oval with tail 												

RDWy (7400h): Read Wy

7400H	RDWy												
	DCX	RDX	WRX	D15-8	D7	D6	D5	D4	D3	D2	D1	D0	HEX
Command	0	1	↑	x	0	1	1	1	0	1	0	0	74
1 st parameter	1	↑	1	x	x	x	x	x	x	x	x	x	x
2 nd parameter	1	↑	1	x	Wy9	Wy8	Wy7	Wy6	Wy5	Wy4	Wy3	Wy2	00
Description	This command returns the Bky bit (Bky[9:2]) of black color characteristic.												
Restriction	-												
Register Availability	Status						Availability						
	Normal Mode On, Idle Mode Off, Sleep Out						Yes						
	Normal Mode On, Idle Mode On, Sleep Out						Yes						
	Partial Mode On, Idle Mode Off, Sleep Out						Yes						
	Partial Mode On, Idle Mode On, Sleep Out						Yes						
	Sleep In						Yes						
Default	Status						Default Value						
							After MTP			Before MTP			
	Power On Sequence						MTP Value			00h			
	SW Reset						MTP Value			00h			
HW Reset						MTP Value			00h				
Flow Chart	<pre> graph TD A[RDWy(74h)] --> B[/Send Parameter Wy[9:2]/] </pre> <p>Legend</p> <ul style="list-style-type: none"> Command Parameter Display Action Mode Sequential transfer 												

RDRGLB (7500h): Read Red/Green Low Bits

7500H	RDRGLB												
	DCX	RDX	WRX	D15-8	D7	D6	D5	D4	D3	D2	D1	D0	HEX
Command	0	1	↑	x	0	1	1	1	0	1	0	1	75
1 st parameter	1	↑	1	x	x	x	x	x	x	x	x	x	x
2 nd parameter	1	↑	1	x	Rx1	Rx0	Ry1	Ry0	Gx1	Gx0	Gy1	Gy0	00
Description	This command returns the lowest bits of red and green color characteristic. Red: Rx and Ry Green: Gx and Gy												
Restriction	-												
Register Availability	Status						Availability						
	Normal Mode On, Idle Mode Off, Sleep Out						Yes						
	Normal Mode On, Idle Mode On, Sleep Out						Yes						
	Partial Mode On, Idle Mode Off, Sleep Out						Yes						
	Partial Mode On, Idle Mode On, Sleep Out						Yes						
	Sleep In						Yes						
Default	Status						Default Value						
							After MTP	Before MTP					
	Power On Sequence						MTP Value	00h					
	SW Reset						MTP Value	00h					
HW Reset						MTP Value	00h						
Flow Chart	<pre> graph TD A[RDRGLB(75h)] --> B[/Send Parameter Rx[1:0], Ry[1:0], Gx[1:0], Gy[1:0]/] </pre>												
	<div style="border: 1px dashed black; padding: 5px;"> <p>Legend</p> <ul style="list-style-type: none"> Command Parameter Display Action Mode Sequential transfer </div>												

RDRx (7600h): Read Rx

7600H	RDRx												
	DCX	RDX	WRX	D15-8	D7	D6	D5	D4	D3	D2	D1	D0	HEX
Command	0	1	↑	x	0	1	1	1	0	1	1	0	76
1 st parameter	1	↑	1	x	x	x	x	x	x	x	x	x	x
2 nd parameter	1	↑	1	x	Rx9	Rx8	Rx7	Rx6	Rx5	Rx4	Rx3	Rx2	00
Description	This command returns the Rx bit (Rx[9:2]) of red color characteristic.												
Restriction	-												
Register Availability	Status						Availability						
	Normal Mode On, Idle Mode Off, Sleep Out						Yes						
	Normal Mode On, Idle Mode On, Sleep Out						Yes						
	Partial Mode On, Idle Mode Off, Sleep Out						Yes						
	Partial Mode On, Idle Mode On, Sleep Out						Yes						
	Sleep In						Yes						
Default	Status						Default Value						
							After MTP			Before MTP			
	Power On Sequence						MTP Value			00h			
	SW Reset						MTP Value			00h			
	HW Reset						MTP Value			00h			
Flow Chart	<pre> graph TD A[RDRx(76h)] --> B[/Send Parameter Rx[9:2]/] </pre> <p>Legend</p> <ul style="list-style-type: none"> Command: Rectangle Parameter: Parallelogram Display: Oval with tail Action: Oval with tail Mode: Oval Sequential transfer: Oval with tail and arrow 												

RDRy (7700h): Read Ry

7700H	RDRy												
	DCX	RDX	WRX	D15-8	D7	D6	D5	D4	D3	D2	D1	D0	HEX
Command	0	1	↑	x	0	1	1	1	0	1	1	1	77
1 st parameter	1	↑	1	x	x	x	x	x	x	x	x	x	x
2 nd parameter	1	↑	1	x	Wy9	Wy8	Wy7	Wy6	Wy5	Wy4	Wy3	Wy2	00
Description	This command returns the Ry bit (Ry[9:2]) of red color characteristic.												
Restriction	-												
Register Availability	Status						Availability						
	Normal Mode On, Idle Mode Off, Sleep Out						Yes						
	Normal Mode On, Idle Mode On, Sleep Out						Yes						
	Partial Mode On, Idle Mode Off, Sleep Out						Yes						
	Partial Mode On, Idle Mode On, Sleep Out						Yes						
	Sleep In						Yes						
Default	Status						Default Value						
							After MTP	Before MTP					
	Power On Sequence						MTP Value	00h					
	SW Reset						MTP Value	00h					
HW Reset						MTP Value	00h						
Flow Chart	<pre> graph TD A[RDRy(77h)] --> B[/Send Parameter Ry[9:2]/] </pre> <p>Legend</p> <ul style="list-style-type: none"> Command: Rectangle Parameter: Parallelogram Display: Pointed rectangle (top-left) Action: Pointed rectangle (top-right) Mode: Rounded rectangle Sequential transfer: Oval with tail 												

RDGx (7800h): Read Gx

7800H	RDGx												
	DCX	RDX	WRX	D15-8	D7	D6	D5	D4	D3	D2	D1	D0	HEX
Command	0	1	↑	x	0	1	1	1	1	0	0	0	78
1 st parameter	1	↑	1	x	x	x	x	x	x	x	x	x	x
2 nd parameter	1	↑	1	x	Gx9	Gx8	Gx7	Gx6	Gx5	Gx4	Gx3	Gx2	00
Description	This command returns the Gx bit (Gx[9:2]) of green color characteristic.												
Restriction	-												
Register Availability	Status						Availability						
	Normal Mode On, Idle Mode Off, Sleep Out						Yes						
	Normal Mode On, Idle Mode On, Sleep Out						Yes						
	Partial Mode On, Idle Mode Off, Sleep Out						Yes						
	Partial Mode On, Idle Mode On, Sleep Out						Yes						
	Sleep In						Yes						
Default	Status						Default Value						
							After MTP	Before MTP					
	Power On Sequence						MTP Value	00h					
	SW Reset						MTP Value	00h					
HW Reset						MTP Value	00h						
Flow Chart	<pre> graph TD A[RDGx(78h)] --> B[/Send Parameter Gx[9:2]/] </pre> <p>Legend</p> <ul style="list-style-type: none"> Command: Rectangle Parameter: Parallelogram Display: Oval Action: Arrowhead Mode: Rounded Rectangle Sequential transfer: Oval with tail 												

RDGy (7900h): Read Gy

7900H	RDGy												
	DCX	RDX	WRX	D15-8	D7	D6	D5	D4	D3	D2	D1	D0	HEX
Command	0	1	↑	x	0	1	1	1	1	0	0	1	79
1 st parameter	1	↑	1	x	x	x	x	x	x	x	x	x	x
2 nd parameter	1	↑	1	x	Gy9	Gy8	Gy7	Gy6	Gy5	Gy4	Gy3	Gy2	00
Description	This command returns the Gy bit (Gy[9:2]) of green color characteristic.												
Restriction	-												
Register Availability	Status						Availability						
	Normal Mode On, Idle Mode Off, Sleep Out						Yes						
	Normal Mode On, Idle Mode On, Sleep Out						Yes						
	Partial Mode On, Idle Mode Off, Sleep Out						Yes						
	Partial Mode On, Idle Mode On, Sleep Out						Yes						
	Sleep In						Yes						
Default	Status						Default Value						
							After MTP			Before MTP			
	Power On Sequence						MTP Value			00h			
	SW Reset						MTP Value			00h			
	HW Reset						MTP Value			00h			
Flow Chart	<pre> graph TD A[RDGy(79h)] --> B[/Send Parameter Gy[9:2]/] </pre> <p>Legend</p> <ul style="list-style-type: none"> Command: Rectangle Parameter: Parallelogram Display: Oval Action: Arrowhead Mode: Rounded Rectangle Sequential transfer: Oval with tail 												

RDBALB (7A00h): Read Red/Green Low Bits

7A00H	RDBALB												
	DCX	RDX	WRX	D15-8	D7	D6	D5	D4	D3	D2	D1	D0	HEX
Command	0	1	↑	x	0	1	1	1	1	0	1	0	7A
1 st parameter	1	↑	1	x	x	x	x	x	x	x	x	x	x
2 nd parameter	1	↑	1	x	Bx1	Bx0	By1	By0	Ax1	Ax0	Ay1	Ay0	00
Description	This command returns the lowest bits of blue and A color characteristic. Blue: Bx and By A: Ax and Ay												
Restriction	-												
Register Availability	Status						Availability						
	Normal Mode On, Idle Mode Off, Sleep Out						Yes						
	Normal Mode On, Idle Mode On, Sleep Out						Yes						
	Partial Mode On, Idle Mode Off, Sleep Out						Yes						
	Partial Mode On, Idle Mode On, Sleep Out						Yes						
	Sleep In						Yes						
Default	Status						Default Value						
							After MTP	Before MTP					
	Power On Sequence						MTP Value	00h					
	SW Reset						MTP Value	00h					
HW Reset						MTP Value	00h						
Flow Chart	<pre> graph TD A[RDBALB(7Ah)] --> B[/Send Parameter Bx[1:0], By[1:0], Ax[1:0], Ay[1:0]/] </pre> <p>Legend</p> <ul style="list-style-type: none"> Command: Rectangle Parameter: Parallelogram Display: Oval Action: Arrowhead Mode: Oval Sequential transfer: Oval with tail 												

RDBx (7B00h): Read Rx

7B00H	RDBx												
	DCX	RDX	WRX	D15-8	D7	D6	D5	D4	D3	D2	D1	D0	HEX
Command	0	1	↑	x	0	1	1	1	1	0	1	1	7B
1 st parameter	1	↑	1	x	x	x	x	x	x	x	x	x	x
2 nd parameter	1	↑	1	x	Bx9	Bx8	Bx7	Bx6	Bx5	Bx4	Bx3	Bx2	00
Description	This command returns the Bx bit (Bx[9:2]) of blue color characteristic.												
Restriction	-												
Register Availability	Status						Availability						
	Normal Mode On, Idle Mode Off, Sleep Out						Yes						
	Normal Mode On, Idle Mode On, Sleep Out						Yes						
	Partial Mode On, Idle Mode Off, Sleep Out						Yes						
	Partial Mode On, Idle Mode On, Sleep Out						Yes						
	Sleep In						Yes						
Default	Status						Default Value						
							After MTP	Before MTP					
	Power On Sequence						MTP Value	00h					
	SW Reset						MTP Value	00h					
	HW Reset						MTP Value	00h					
Flow Chart	<pre> graph TD A[RDBx(7Bh)] --> B[/Send Parameter Bx[9:2]/] </pre> <p>Legend</p> <ul style="list-style-type: none"> Command: Rectangle Parameter: Parallelogram Display: Oval Action: Arrow Mode: Rounded Rectangle Sequential transfer: Oval with tail 												

RDBy (7C00h): Read By

7C00H	RDBy												HEX
	DCX	RDX	WRX	D15-8	D7	D6	D5	D4	D3	D2	D1	D0	
Command	0	1	↑	x	0	1	1	1	1	1	0	0	7C
1 st parameter	1	↑	1	x	x	x	x	x	x	x	x	x	x
2 nd parameter	1	↑	1	x	By9	By8	By7	By6	By5	By4	By3	By2	00
Description	This command returns the By bit (By[9:2]) of blue color characteristic.												
Restriction	-												
Register Availability	Status						Availability						
	Normal Mode On, Idle Mode Off, Sleep Out						Yes						
	Normal Mode On, Idle Mode On, Sleep Out						Yes						
	Partial Mode On, Idle Mode Off, Sleep Out						Yes						
	Partial Mode On, Idle Mode On, Sleep Out						Yes						
	Sleep In						Yes						
Default	Status						Default Value						
							After MTP			Before MTP			
	Power On Sequence						MTP Value			00h			
	SW Reset						MTP Value			00h			
HW Reset						MTP Value			00h				
Flow Chart	<pre> graph TD A[RDBy(7Ch)] --> B[/Send Parameter By[9:2]/] </pre> <p>Legend</p> <ul style="list-style-type: none"> Command: Rectangle Parameter: Parallelogram Display: Oval Action: Arrow Mode: Rounded Rectangle Sequential transfer: Oval with tail 												

RDAx (7D00h): Read Ax

7D00H	RDAx												
	DCX	RDX	WRX	D15-8	D7	D6	D5	D4	D3	D2	D1	D0	HEX
Command	0	1	↑	x	0	1	1	1	1	1	0	1	7D
1 st parameter	1	↑	1	x	x	x	x	x	x	x	x	x	x
2 nd parameter	1	↑	1	x	Ax9	Ax8	Ax7	Ax6	Ax5	Ax4	Ax3	Ax2	00
Description	This command returns the Ax bit (Ax[9:2]) of A color characteristic.												
Restriction	-												
Register Availability	Status						Availability						
	Normal Mode On, Idle Mode Off, Sleep Out						Yes						
	Normal Mode On, Idle Mode On, Sleep Out						Yes						
	Partial Mode On, Idle Mode Off, Sleep Out						Yes						
	Partial Mode On, Idle Mode On, Sleep Out						Yes						
	Sleep In						Yes						
Default	Status						Default Value						
							After MTP	Before MTP					
	Power On Sequence						MTP Value	00h					
	SW Reset						MTP Value	00h					
	HW Reset						MTP Value	00h					
Flow Chart	<pre> graph TD A[RDAx(7Dh)] --> B[/Send Parameter Ax[9:2]/] </pre> <p>Legend</p> <ul style="list-style-type: none"> Command: Rectangle Parameter: Parallelogram Display: Oval Action: Arrowhead Mode: Rounded Rectangle Sequential transfer: Oval with tail 												

RDAy (7E00h): Read Ay

7E00H	RDAy												
	DCX	RDX	WRX	D15-8	D7	D6	D5	D4	D3	D2	D1	D0	HEX
Command	0	1	↑	x	0	1	1	1	1	1	1	0	7E
1 st parameter	1	↑	1	x	x	x	x	x	x	x	x	x	x
2 nd parameter	1	↑	1	x	Ay9	Ay8	Ay7	Ay6	Ay5	Ay4	Ay3	Ay2	00
Description	This command returns the Ay bit (Ay[9:2]) of A color characteristic.												
Restriction	-												
Register Availability	Status						Availability						
	Normal Mode On, Idle Mode Off, Sleep Out						Yes						
	Normal Mode On, Idle Mode On, Sleep Out						Yes						
	Partial Mode On, Idle Mode Off, Sleep Out						Yes						
	Partial Mode On, Idle Mode On, Sleep Out						Yes						
	Sleep In						Yes						
Default	Status						Default Value						
							After MTP			Before MTP			
	Power On Sequence						MTP Value			00h			
	SW Reset						MTP Value			00h			
	HW Reset						MTP Value			00h			
Flow Chart	<pre> graph TD A[RDAy(7Eh)] --> B[/Send Parameter Ay[9:2]/] </pre> <p>Legend</p> <ul style="list-style-type: none"> Command: Rectangle Parameter: Parallelogram Display: Oval Action: Arrowhead Mode: Rounded Rectangle Sequential transfer: Oval with tail 												

RDDDBS(A1h) : Read_DDB_Start (A1h)

A1H	RDDDBS(Read_DDB_Start)																								
	DCX	RDX	WRX	D15-8	D7	D6	D5	D4	D3	D2	D1	D0	HEX												
Command	0	1	↑	x	1	0	1	0	0	0	0	1	A1												
1 st parameter	1	↑	1	x	x	x	x	x	x	x	x	x	x												
2 nd parameter	1	↑	1	xx	ID1[15]	ID1[14]	ID1[13]	ID1[12]	ID1[11]	ID1[10]	ID1[9]	ID1[8]	00												
3 rd parameter	1	↑	1	xx	ID1[7]	ID1[6]	ID1[5]	ID1[4]	ID1[3]	ID1[2]	ID1[1]	ID1[0]	00												
4 th parameter	1	↑	1	xx	ID2[15]	ID2[14]	ID2[13]	ID2[12]	ID2[11]	ID2[10]	ID2[9]	ID2[8]	00												
5 th parameter	1	↑	1	xx	ID2[7]	ID2[6]	ID2[5]	ID2[4]	ID2[3]	ID2[2]	ID2[1]	ID2[0]	00												
6 th parameter	1	↑	1	xx	1	1	1	1	1	1	1	1	FF												
Description	1 st parameter: Dummy read 2 nd parameter: Supplier ID code 3 rd parameter: Supplier ID code 4 th parameter: Module ID 5 th parameter: Module ID																								
Restriction																									
Register Availability	<table border="1"> <thead> <tr> <th>Status</th> <th>Availability</th> </tr> </thead> <tbody> <tr> <td>Normal Mode On, Idle Mode Off, Sleep Out</td> <td>Yes</td> </tr> <tr> <td>Normal Mode On, Idle Mode On, Sleep Out</td> <td>Yes</td> </tr> <tr> <td>Partial Mode On, Idle Mode Off, Sleep Out</td> <td>Yes</td> </tr> <tr> <td>Partial Mode On, Idle Mode On, Sleep Out</td> <td>Yes</td> </tr> <tr> <td>Sleep In</td> <td>Yes</td> </tr> </tbody> </table>													Status	Availability	Normal Mode On, Idle Mode Off, Sleep Out	Yes	Normal Mode On, Idle Mode On, Sleep Out	Yes	Partial Mode On, Idle Mode Off, Sleep Out	Yes	Partial Mode On, Idle Mode On, Sleep Out	Yes	Sleep In	Yes
Status	Availability																								
Normal Mode On, Idle Mode Off, Sleep Out	Yes																								
Normal Mode On, Idle Mode On, Sleep Out	Yes																								
Partial Mode On, Idle Mode Off, Sleep Out	Yes																								
Partial Mode On, Idle Mode On, Sleep Out	Yes																								
Sleep In	Yes																								

Default	Status		Default Value	
			After MTP	Before MTP
	Power On Sequence		MTP Value	00h
	SW Reset		MTP Value	00h
HW Reset		MTP Value	00h	

Flow Chart	Serial I/F Mode		Parallel I/F Mode		<p style="text-align: center;">Host Driver</p> <div style="border: 1px dashed black; padding: 5px;"> <p style="text-align: center;">Legend</p> <div style="display: flex; flex-direction: column; align-items: center;"> <div style="border: 1px solid black; width: 40px; height: 15px; margin-bottom: 5px;"></div> <div style="margin-bottom: 5px;">Command</div> <div style="border: 1px solid black; width: 40px; height: 15px; transform: rotate(-15deg); margin-bottom: 5px;"></div> <div style="margin-bottom: 5px;">Parameter</div> <div style="border: 1px solid black; width: 40px; height: 15px; border-radius: 5px; margin-bottom: 5px;"></div> <div style="margin-bottom: 5px;">Display</div> <div style="border: 1px solid black; width: 40px; height: 15px; border-radius: 5px; margin-bottom: 5px;"></div> <div style="margin-bottom: 5px;">Action</div> <div style="border: 1px solid black; width: 40px; height: 15px; border-radius: 5px; margin-bottom: 5px;"></div> <div style="margin-bottom: 5px;">Mode</div> <div style="border: 1px solid black; width: 40px; height: 15px; border-radius: 5px; margin-bottom: 5px;"></div> <div style="margin-bottom: 5px;">Sequential transfer</div> </div> </div>
	RDDDBS (A1h)		RDDDBS (A1h)		
	↓		↓		
	Dummy Clock		Dummy Read		
	↓		↓		
	Send ID1[15:8]		Send ID1[15:8]		
	↓		↓		
	Send ID1[7:0]		Send ID1[7:0]		
	↓		↓		
	Send ID2[15:8]		Send ID2[15:8]		
	↓		↓		
	Send ID2[7:0]		Send ID2[7:0]		
↓		↓			
Send FFh		Send FFh			

RDDDBC(A800h) : Read DDB Contin

A800H	RDDDBC																								
	DCX	RDX	WRX	D15-8	D7	D6	D5	D4	D3	D2	D1	D0	HEX												
Command	0	1	↑	x	1	0	1	0	1	0	0	0	A8												
1 st parameter	1	↑	1	x	x	x	x	x	x	x	x	x	x												
2 nd parameter	1	↑	1	xx	ID1[15]	ID1[14]	ID1[13]	ID1[12]	ID1[11]	ID1[10]	ID1[9]	ID1[8]	00												
3 rd parameter	1	↑	1	xx	ID1[7]	ID1[6]	ID1[5]	ID1[4]	ID1[3]	ID1[2]	ID1[1]	ID1[0]	00												
4 th parameter	1	↑	1	xx	ID2[15]	ID2[14]	ID2[13]	ID2[12]	ID2[11]	ID2[10]	ID2[9]	ID2[8]	00												
5 th parameter	1	↑	1	xx	ID2[7]	ID2[6]	ID2[5]	ID2[4]	ID2[3]	ID2[2]	ID2[1]	ID2[0]	00												
6 th parameter	1	↑	1	xx	1	1	1	1	1	1	1	1	FF												
Description	<p>This command returns the supplier identification and display module mode/revision information from the point where RDDDBS command was interrupted by an other command.</p> <p><i>Note: Parameter 0xFF is an "Exit Code", this means that there is no more data in the DDB block.</i></p> <p><i>Note: For use example,</i></p> <ol style="list-style-type: none"> 1. Set maximum return packet size=3 2. Read 0xA1, return 3 bytes SID[7:0], SID[15:8], MID[7:0] 3. Read 0xA8, return 2 bytes MID[15:8] and 0xFF 																								
Restriction	<p>A Read DDB Start command (RDDDBS) should be executed at least once before a Read DDB Continue command (RDDDBC) to define the read location. Otherwise, data read with a Read DDB Continue command is undefined.</p>																								
Register Availability	<table border="1"> <thead> <tr> <th>Status</th> <th>Availability</th> </tr> </thead> <tbody> <tr> <td>Normal Mode On, Idle Mode Off, Sleep Out</td> <td>Yes</td> </tr> <tr> <td>Normal Mode On, Idle Mode On, Sleep Out</td> <td>Yes</td> </tr> <tr> <td>Partial Mode On, Idle Mode Off, Sleep Out</td> <td>Yes</td> </tr> <tr> <td>Partial Mode On, Idle Mode On, Sleep Out</td> <td>Yes</td> </tr> <tr> <td>Sleep In</td> <td>Yes</td> </tr> </tbody> </table>													Status	Availability	Normal Mode On, Idle Mode Off, Sleep Out	Yes	Normal Mode On, Idle Mode On, Sleep Out	Yes	Partial Mode On, Idle Mode Off, Sleep Out	Yes	Partial Mode On, Idle Mode On, Sleep Out	Yes	Sleep In	Yes
Status	Availability																								
Normal Mode On, Idle Mode Off, Sleep Out	Yes																								
Normal Mode On, Idle Mode On, Sleep Out	Yes																								
Partial Mode On, Idle Mode Off, Sleep Out	Yes																								
Partial Mode On, Idle Mode On, Sleep Out	Yes																								
Sleep In	Yes																								

Default	Status		Default Value		
			After MTP	Before MTP	
	Power On Sequence		MTP Value	00h	
	SW Reset		MTP Value	00h	
		HW Reset		MTP Value	00h

Flow Chart		
	<p style="text-align: center;">RDDDBC(A8h)</p> <p style="text-align: center;">↓</p> <p style="text-align: center;">RDDDBS Data D1[7:0], D2[7:0], ..., Dn[7:0]</p>	

RDFCS(AA00h) : Read First Checksum

AA00H	RDFCS												
	DCX	RDX	WRX	D15-8	D7	D6	D5	D4	D3	D2	D1	D0	HEX
Command	0	1	↑	x	1	0	1	0	1	0	1	0	AA
1 st parameter	1	↑	1	x	x	x	x	x	x	x	x	x	x
2 nd parameter	1	↑	1	xx	FCS7	FCS6	FCS5	FCS4	FCS3	FCS2	FCS1	FCS0	00
Description	This command returns the first checksum what has been calculated from “User Command Set” area registers (not include “Manufacture Command Set) and the frame memory after the write access to those registers and/or frame memory has been done.												
Restriction	It will be necessary to wait 150ms after there is the last write access on “User Command Set” area registers before there can read this checksum value.												
Register Availability	Status						Availability						
	Normal Mode On, Idle Mode Off, Sleep Out						Yes						
	Normal Mode On, Idle Mode On, Sleep Out						Yes						
	Partial Mode On, Idle Mode Off, Sleep Out						Yes						
	Partial Mode On, Idle Mode On, Sleep Out						Yes						
	Sleep In						Yes						
Default	Status						Default Value						
	Power On Sequence						00h						
	S/W Reset						00h						
	H/W Reset						00h						

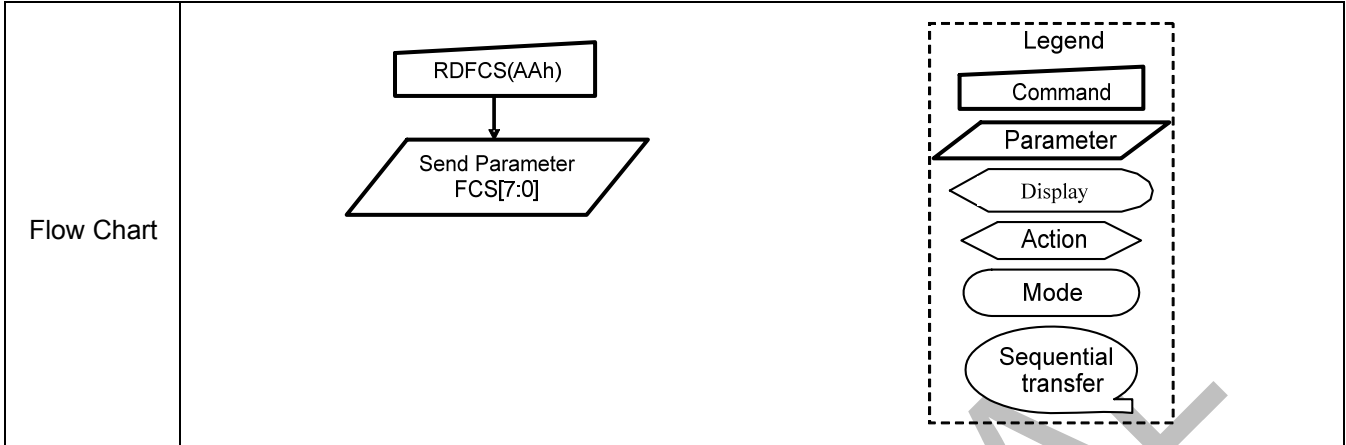

CONFIDENTIAL

RDCCS(AF00h) : Read Continue Checksum

AF00H	RDCCS												
	DCX	RDX	WRX	D15-8	D7	D6	D5	D4	D3	D2	D1	D0	HEX
Command	0	1	↑	x	1	0	1	0	1	1	1	1	AF
1 st parameter	1	↑	1	x	x	x	x	x	x	x	x	x	x
2 nd parameter	1	↑	1	xx	CCS7	CCS6	CCS5	CCS4	CCS3	CCS2	CCS1	CCS0	00
Description	This command returns the continue checksum what has been calculated continuously after the first checksum has calculated from "User Command Set" area registers and the frame memory after the write access to those registers and/or frame memory has been done.												
Restriction	It will be necessary to wait 300ms after there is the last write access on "User Command Set" area registers before there can read this checksum value in the first time.												
Register Availability	Status						Availability						
	Normal Mode On, Idle Mode Off, Sleep Out						Yes						
	Normal Mode On, Idle Mode On, Sleep Out						Yes						
	Partial Mode On, Idle Mode Off, Sleep Out						Yes						
	Partial Mode On, Idle Mode On, Sleep Out						Yes						
	Sleep In						Yes						
Default	Status						Default Value						
	Power On Sequence						00h						
	S/W Reset						00h						
	H/W Reset						00h						

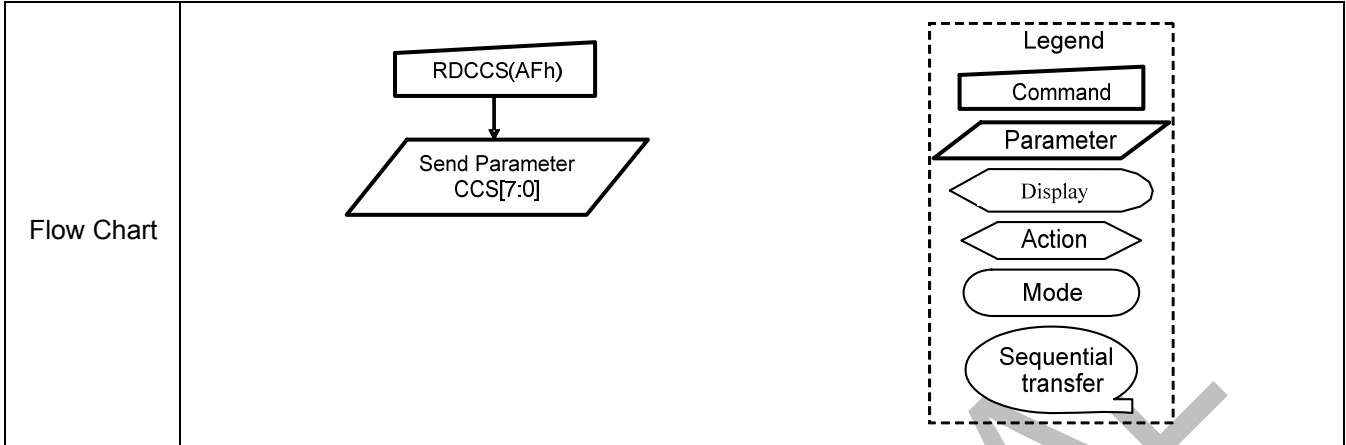

CONFIDENTIAL

RDID1(DA00h) : Read ID1

DA00H	RDID1												
	DCX	RDX	WRX	D15-8	D7	D6	D5	D4	D3	D2	D1	D0	HEX
Command	0	1	↑	x	1	1	0	1	1	0	1	0	DA
1 st parameter	1	↑	1	x	x	x	x	x	x	x	x	x	x
2 nd parameter	1	↑	1	xx	ID17	ID16	ID15	ID14	ID13	ID12	ID11	ID10	00
Description	This read byte identifies the TFT LCD module's manufacture ID.												
Restriction	-												
Register Availability	Status						Availability						
	Normal Mode On, Idle Mode Off, Sleep Out						Yes						
	Normal Mode On, Idle Mode On, Sleep Out						Yes						
	Partial Mode On, Idle Mode Off, Sleep Out						Yes						
	Partial Mode On, Idle Mode On, Sleep Out						Yes						
	Sleep In						Yes						
Default	Status						Default Value						
	Power On Sequence						00h						
	SW Reset						00h						
	HW Reset						00h						
Flow Chart	<pre> graph TD A[RDID1(DAh)] --> B[/Send Parameter ID1[7:0]/] </pre> <p>Legend</p> <ul style="list-style-type: none"> Command: Rectangle Parameter: Parallelogram Display: Oval Action: Arrowhead Mode: Rounded rectangle Sequential transfer: Oval with tail 												

RDID2(DB00h) : Read ID2

DB00H	RDID2												
	DCX	RDX	WRX	D15-8	D7	D6	D5	D4	D3	D2	D1	D0	HEX
Command	0	1	↑	x	1	1	0	1	1	0	1	1	DB
1 st parameter	1	↑	1	x	x	x	x	x	x	x	x	x	x
2 nd parameter	1	↑	1	xx	ID27	ID26	ID25	ID24	ID23	ID22	ID21	ID20	00
Description	This read byte is used to track the TFT LCD module/driver version. It is changed each time a version is made to the display, material or construction specifications. Parameter Range: ID2 = 80h to FFh												
Restriction	-												
Register Availability	Status						Availability						
	Normal Mode On, Idle Mode Off, Sleep Out						Yes						
	Normal Mode On, Idle Mode On, Sleep Out						Yes						
	Partial Mode On, Idle Mode Off, Sleep Out						Yes						
	Partial Mode On, Idle Mode On, Sleep Out						Yes						
	Sleep In						Yes						
Default	Status						Default Value						
							After MTP	Before MTP					
	Power On Sequence						MTP Value	80h					
	SW Reset						MTP Value	80h					
HW Reset						MTP Value	80h						

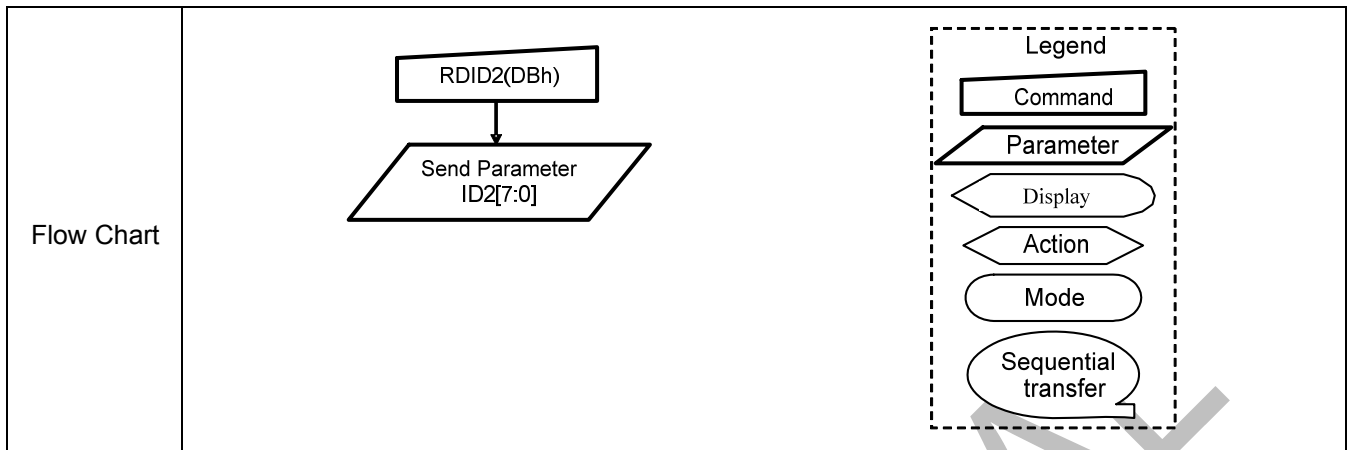

CONFIDENTIAL

RDID3(DC00h) : Read ID3

DC00H	RDID3												
	DCX	RDX	WRX	D15-8	D7	D6	D5	D4	D3	D2	D1	D0	HEX
Command	0	1	↑	x	1	1	0	1	1	1	0	0	DC
1 st parameter	1	↑	1	x	x	x	x	x	x	x	x	x	x
2 nd parameter	1	↑	1	xx	ID37	ID36	ID35	ID34	ID33	ID32	ID31	ID30	00
Description	This parameter read byte identifies the TFT LCD module/driver.												
Restriction	-												
Register Availability	Status						Availability						
	Normal Mode On, Idle Mode Off, Sleep Out						Yes						
	Normal Mode On, Idle Mode On, Sleep Out						Yes						
	Partial Mode On, Idle Mode Off, Sleep Out						Yes						
	Partial Mode On, Idle Mode On, Sleep Out						Yes						
	Sleep In						Yes						
Default	Status						Default Value						
							After MTP	Before MTP					
	Power On Sequence						MTP Value	00h					
	SW Reset						MTP Value	00h					
HW Reset						MTP Value	00h						

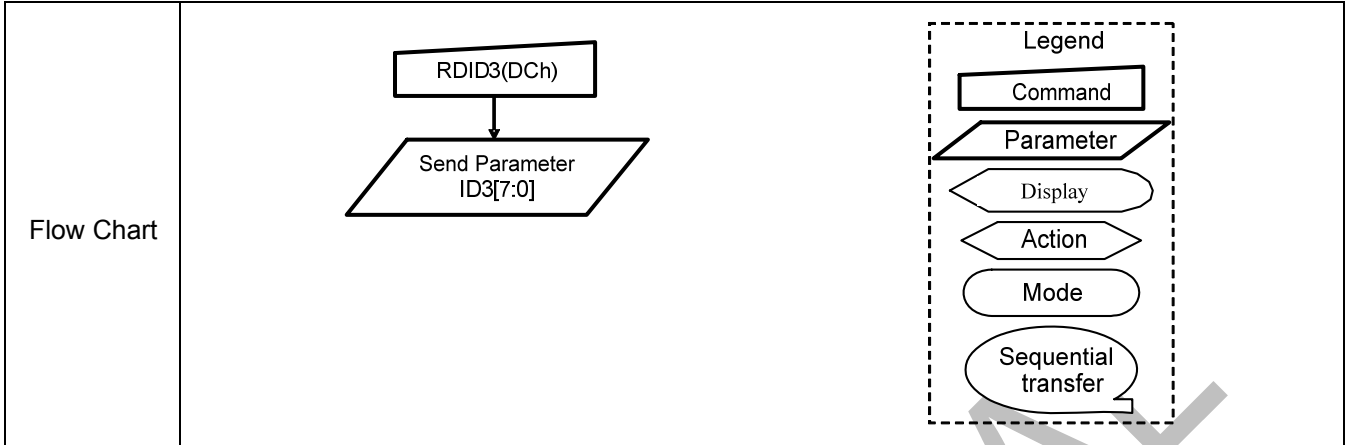

CONFIDENTIAL

9. Electrical Characteristics

9.1 Absolute Maximum Ratings

The absolute maximum rating is listed on following table. When RM68120 is used out of the absolute maximum ratings, the RM68120 may be permanently damaged. To use the RM68120 within the following electrical characteristics limit is strongly recommended for normal operation. If these electrical characteristic conditions are exceeded during normal operation, the RM68120 will malfunction and cause poor reliability.

item	Symbol	Value	Unit
Power supply voltage	VDDI	-0.3 ~ + 5.5	V
Power supply voltage	VDDA, VDDDB, VDDR, VDDAM	-0.3 ~ + 5.5	V
Supply voltage (Digital)	DVDD, DIOPWR	-0.3 ~ + 2.0	V
Supply voltage (MV)	AVDD-AVSS	-0.3 ~ + 6.6	V
	AVEE-AVSS	-0.3 ~ + 6.6	V
Supply voltage (HV)	VGH - VGLX	-0.3 ~ + 33	V
Input voltage	VIN	-0.3 ~ VDDI+ 0.3	V
Output voltage	VO	-0.3 ~ VDDI+ 0.3	V
Differential input voltage	HSSI_CLK_P/N	-0.3 ~ +1.8	V
	HSSI_DATA0_P/N		
	HSSI_DATA1_P/N		
Operating temperature	Topr	-40 ~ + 85	°C
Storage temperature	Tstg	-55 ~ + 125	°C
Notes: If one of the above items is exceeded its maximum limitation momentarily, the quality of the product may be degraded. Absolute maximum limitation. Therefore, specify the values exceeding which the product may be physically damaged. Be sure to use the product within the recommend range.			

9.2 ESD Protection Level

Model	Test Condition	Level
Human Body Mode	R = 1.5 kohm / C = 100 pF	> 2.5KV
Machine Mode	R = 0 ohm / C = 200 pF	> 250V

9.3 Latch-Up Protection Level

The device will not latch up at trigger current levels less than ± 200 mA.

9.4 Light Sensitivity

The operation of the IC will not be materially altered by incident light.

9.5 DC Characteristics

9.5.1 Basic Characteristics

Parameter	Symbol	Condition	Min.	Typ.	Max.	Unit	Related Pins
Analog Power Supply Voltage	VCI	Operation Voltage	2.3	3.7	4.8	V	Note 1
I/O pin Power Supply Voltage	VDDI	I/O supply voltage	1.65	2.8	3.3	V	Note 1
	VDDIL	I/O supply voltage	1.1	1.2	1.3	V	Note 1
Logic High level input voltage	VIH	VDDI = 1.65V ~ 3.3V	0.7* VDDI	-	VDDI	V	Note 2
Logic Low level input voltage	VIL	VDDI = 1.65V ~ 3.3V	0.0	-	0.3* VDDI	V	Note 2
Logic High level Output voltage	VOH	Iout = -1 mA	0.8* VDDI	-	VDDI	V	Note 2
Logic Low level Output voltage	VOL	Iout = +1 mA	0.0	-	0.2* VDDI	V	Note 2
Logic High level input current (Except MIPI/MDDI)	IIHD	Vin=0~VDDI			1	uA	Note 2
Logic Low level input current (Except MIPI/MDDI)	IILD	Vin=0~VDDI	-1			uA	Note 2
Logic High level input current (MIPI/MDDI)	IIHD	Vin=0~VDDAM			1	uA	Note 2
Logic Low level input current (MIPI/MDDI)	IILD	Vin=0~VDDAM	-1			uA	Note 2
AVDD booster voltage	AVDD		4.5		6.5	V	
AVEE booster voltage	AVEE		-6.5		-4.5	V	
VCL booster voltage	VCL		-2.5		-4	V	
VGH booster voltage	VGH		AVDD +VDDDB		2AVDD -AVEE	V	
VGLX booster voltage	VGLX		AVEE +VCL		2AVEE -AVDD	V	
Voltage difference between VGH and VGLX	VGHL	VGH-VGLX			30	V	
VCOM Amplitude voltage	VCOM		-3.5		0.0	V	
Gamma reference voltage	VGMP		3.0		6.3	V	Note 3
	VGSP		0.0		3.7	V	Note 3
	VGMN		-6.3		-3.0	V	Note 3
	VGSN		-3.7		0.0	V	Note 3
Output offset voltage	V _{OFFSET}				45	mV	Note 3
Output deviation voltage	V _{DEV}	Sout≥4.0V, Sout≤1.0V			20	mV	Note 3
		1.0V<Sout<4.0V			10	mV	Note 3

Notes: 1. VDDI=1.65 to 3.3V, VDD=2.3 to 4.8V, VSSI=VSS=DVSS=0V, VDD means VDDA, VDDR, VDDDB, VDDIM, VDDAM and VSS means VSSA, VSSR, VSSB, AVSS, VSSIM, VSSAM. VDDDB, VDDA and VDDR should be the same input voltage level.

2. TA = -30 to 85 °C.

3. Source channel loading =5KΩ+55pF/channel.

9.5.2 MIPI Characteristics

High-Speed Receiver Specification

DC Specifications

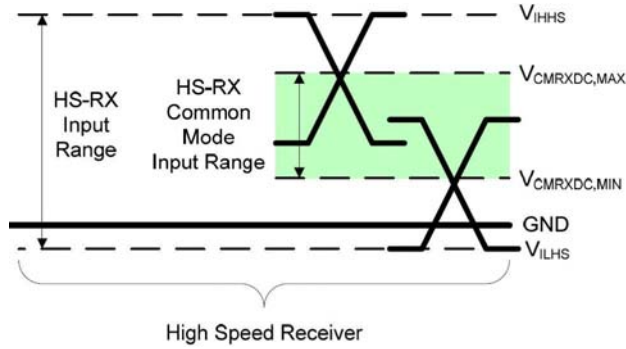

Parameter	Description	Min	Nom	Max	Units	Note
VCMRX(DC)	Common-mode voltage HS receive mode	70		330	mV	1,2
VIDTH	Differential input high threshold			70	mV	
VIDTL	Differential input low threshold	-70			mV	
VIHHS	Single-ended input high voltage			460	mV	1
VILHS	Single-ended input low voltage	-40			mV	1
ZID	Differential input impedance	80	100	125	Ω	

Notes:

1. Excluding possible additional RF interference of 100mV peak sine wave beyond 450MHz.
2. This table value includes a ground difference of 50mV between the transmitter and the receiver, the static common-mode level tolerance and variations below 450MHz

Forward high speed transmissions

DDR Clock Definition

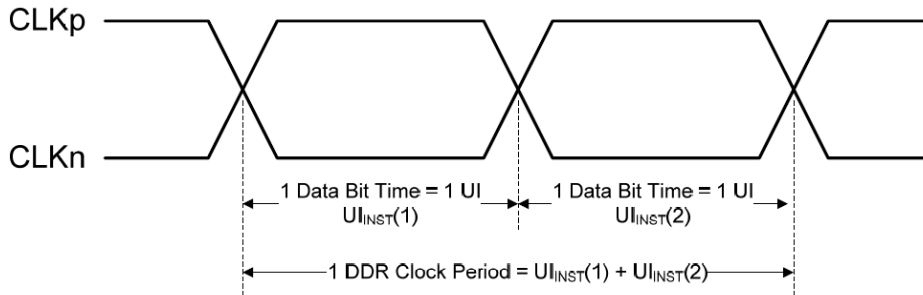

Clock Parameter	Symbol	Min	Typ	Max	Units	Notes
UI instantaneous	UI_{INST}			12.5	ns	1,2

Notes:

1. This value corresponds to a minimum 80 Mbps data rate.
2. The minimum UI shall not be violated for any single bit period, i.e., any DDR half cycle within a data burst.

Data-Clock Timing Specifications

Parameter	Symbol	Min	Typ	Max	Units	Notes
Data to Clock Skew [measured at transmitter]	$T_{SKEW[TX]}$	-0.15		0.15	UI_{INST}	1
Data to Clock Setup Time [receiver]	$T_{SETUP[RX]}$	0.15			UI_{INST}	2
Clock to Data Hold Time [receiver]	$T_{HOLD[RX]}$	0.15			UI_{INST}	2

Notes:

1. Total silicon and package delay budget of $0.3 * UI_{INST}$
2. Total setup and hold window for receiver of $0.3 * UI_{INST}$

Data to Clock Timing Definitions

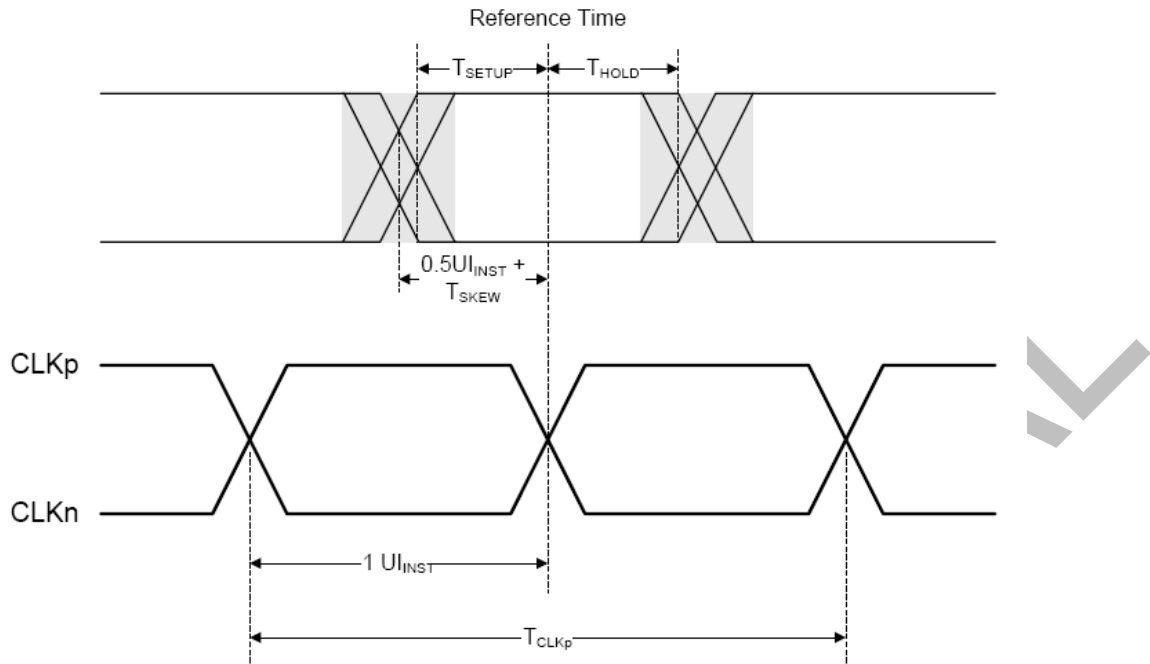

CONFIDENTIAL

Low power transceiver specifications

Parameters	Symbol	Condition	Min	Typ	Max	Unit
Logic high level input voltage	VIHCD	Contention Detection (Lane_D0)	450		1350	mV
Logic low level input voltage	VILCD	Contention Detection (Lane_D0)	0		200	mV
Logic high level input voltage	VIH-LPRX	LP-Rx (Lane_CK, Lane_D0, Lane_D1)	880	-	1350	mV
Logic low level input voltage	VIL-LPRX	LP-Rx (Lane_CK, Lane_D0, Lane_D1)	0		550	mV
Logic low level input voltage	VIL-ULPS	LP-Rx ULPS (Lane_CK, Lane_D0, Lane_D1)	0		300	mV
Logic high level input voltage	VOH-LPTX	Contention Detection (Lane_D0)	1.1	1.2	1.3	V
Logic low level input voltage	VOL-LPTX	Contention Detection (Lane_D0)	-50	0	50	mV
eSPIKE ^(1,2,3)	Fig. 2	Input pulse rejection			300	V.ps

Notes:

- Time-voltage integration of a spike above VIL when being in LP-0 state or below VIH when being in LP-1 State.
- An impulse less than this will not change the receiver state.
- In addition to the required glitch rejection, implementers shall ensure rejection of known RF-interferers.

Input Glitch Rejection of Low Power Receivers as follow.

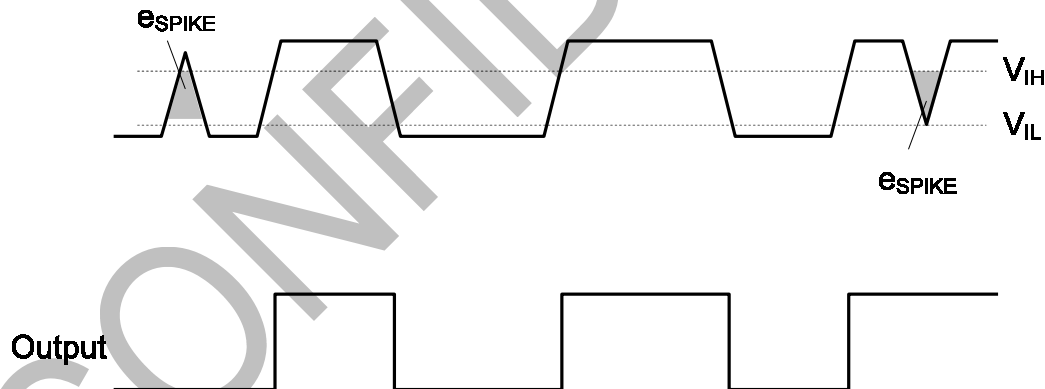

9.5.3 MDDI Characteristics

Characteristics

Parameter	Symbol	Conditions	Specification			UNIT
			MIN	TYP	MAX	
Differential input "High" level voltage (hibernation wake-up)	$V_{IT+offset}$	VT=125mv (MDDI_DATA_P/M)	-	100	125	mv
Differential input "Low" level voltage (hibernation wake-up)	$V_{IT-offset}$	VT=125mv (MDDI_DATA_P/M)	75	100	-	mv
Differential input "High" level voltage	V_{IT+}	VT=0mv (MDDI_STB_P/M ,MDDI_DATA_P/M)	-	0	50	mv
Differential input "Low" level voltage	V_{IT-}	VT=0mv (MDDI_STB_P/M ,MDDI_DATA_P/M)	-50	0	-	mv
Terminal impedance	Zt	-	80	-	125	ohm

Note 1) VDDI= 1.65~3.3V, VDD=2.3 to 4.8V, VSSI=VSS=VSSAM=0V, Ta=-30 to 70 °C (to +85 °C no damage). VDD means VDDAM, VDDA, VDDR, Vddb and VSS means VSSAM, VSSA, VSSR, VSSB, AVSS.

9.6 AC Characteristics

9.6.1 Parallel Interface Characteristics (80-Series MCU)

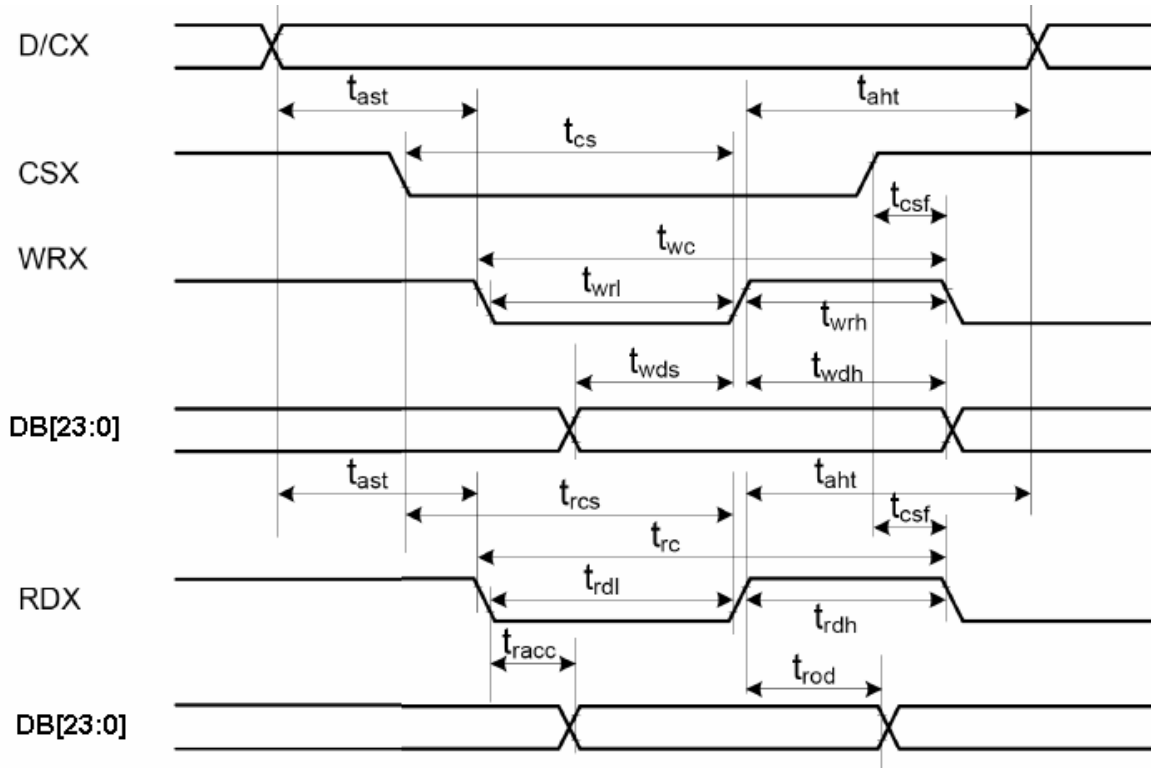

Signal	Symbol	Parameter	min	max	Unit	Description
DCX	T_{ast}	Address setup time	10	-	ns	
	T_{aht}	Address hold time (Write/Read)	2	-	ns	
CSX	T_{cs}	Chip Select setup time (Write)	20	-	ns	
	T_{RCS}	Chip Select setup time (Read)	20	-	ns	
	T_{csf}	Chip Select Wait time (Write/Read)	20	-	ns	
WRX	T_{wc}	Write cycle	33	-	ns	
	T_{wrh}	Write Control pulse H duration	15	-	ns	
	T_{wrl}	Write Control pulse L duration	15	-	ns	
RDX	T_{rc}	Read cycle	400	-	ns	Read from frame memory
	T_{rdh}	Read Control pulse H duration	250	-	ns	
	T_{rdl}	Read Control pulse L duration	150	-	ns	
DB[23:0]	T_{wds}	Write data setup time	15	-	ns	
	T_{wdh}	Write data hold time	10	-	ns	
	T_{racc}	Read access time		150	ns	
	T_{rdh}	Read output disable time	5	-	ns	

Note: Logic high and low levels are specified as 20% and 80% of IOVCC for Input signals.

Note: $T_a = -30$ to 70 °C, IOVCC=1.65V to 3.3V, VCI=2.5V to 4.8V, GND=0V

9.6.2 Serial Interface Characteristics

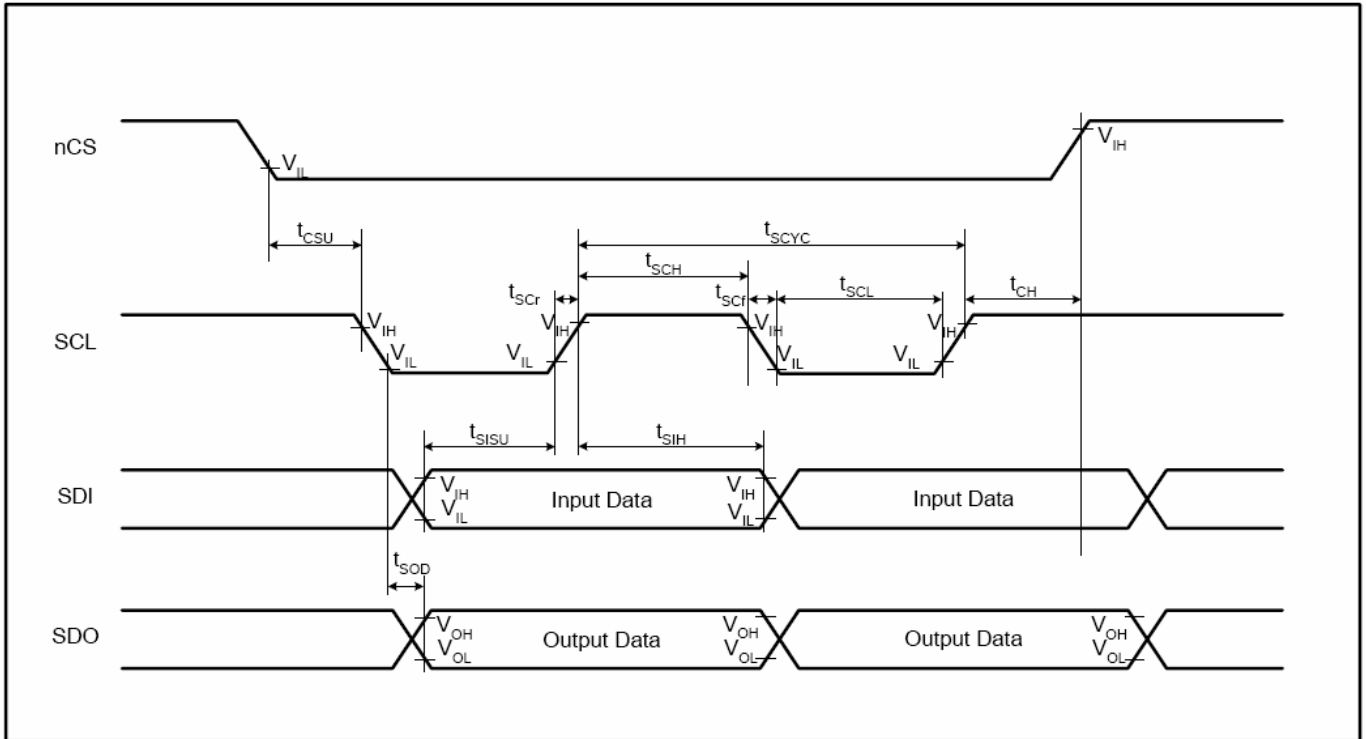

Signal	Symbol	Parameter	MIN	MAX	Unit	Description
SCL	T _{SCYC}	Clock cycle (Write)	100		ns	-
	T _{SCYC}	Clock cycle (Read)	300		ns	
	T _{SCH}	Clock "H" pulse width (Write)	40		ns	
	T _{SCH}	Clock "H" pulse width (Read)	140		ns	
	T _{SCL}	Clock "L" pulse width (Write)	40		ns	
	T _{SCL}	Clock "L" pulse width (Read)	140		ns	
	T _{SCR}	Clock rise time		5	ns	
	T _{SCF}	Clock fall time		5	ns	
nCS	T _{CSU}	Chip select setup time	20		ns	-
	T _{CH}	Chip select hold time	50		ns	
SDI	T _{SISU}	Data input setup time	20		ns	-
	T _{SIH}	Data input hold time	20		ns	
SDO	T _{SOD}	Data output setup time		120	ns	-
	T _{SOH}	Data output hold time	5		ns	

Note: Logic high and low levels are specified as 20% and 80% of IOVCC for Input signals.

Note: Ta = -30 to 70 °C, IOVCC=1.65V to 3.3V, VCI=2.5V to 4.8V, GND=0V

9.6.3 I2C Bus Timing Characteristics

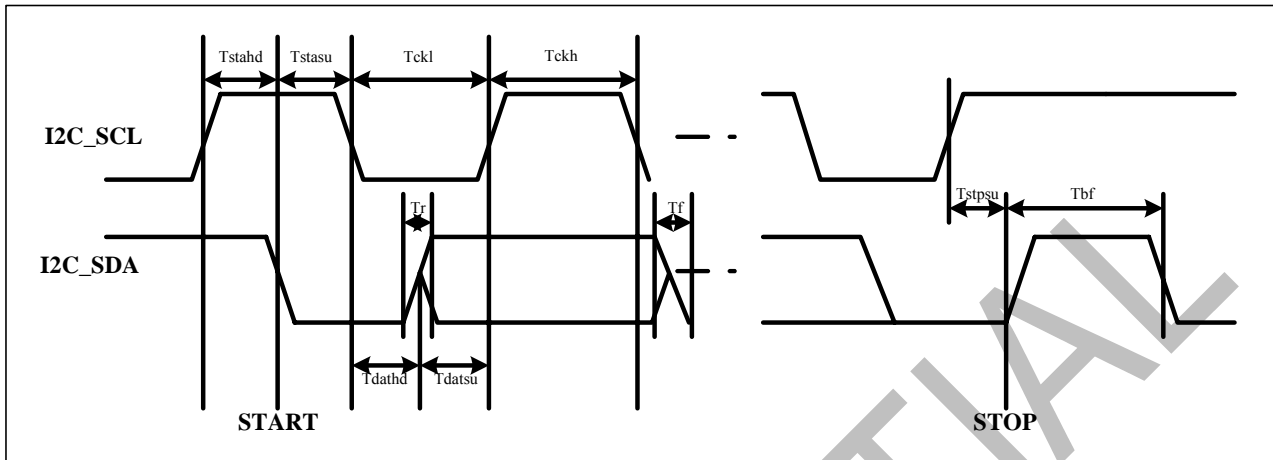

Signal	Symbol	Parameter	MIN	MAX	Unit
I2C_SCL	$T_{ckl} + T_{ckh}$	Operate frequency	-	400	KHz
	T_{ckl}	CLK low	1300	-	ns
	T_{ckh}	CLK high	600	-	ns
I2C_SDA	T_r	Data rising time	-	300	ns
	T_f	Data falling time	-	300	ns
	T_{dathd}	Data hold time	0	900	ns
	T_{datsu}	Data setup time	100	-	ns
	T_{stahd}	Start hold time	600	-	ns
	T_{stasu}	Start setup time	600	-	ns
	T_{stpsu}	Stop setup time	600	-	ns
	T_{bf}	Bus free time	1300	-	ns

Note: Logic high and low levels are specified as 20% and 80% of IOVCC for Input signals.

Note: $T_a = -30$ to 70 °C, IOVCC=1.65V to 3.3V, VCI=2.5V to 4.8V, GND=0V

9.6.4 RGB Interface Characteristics

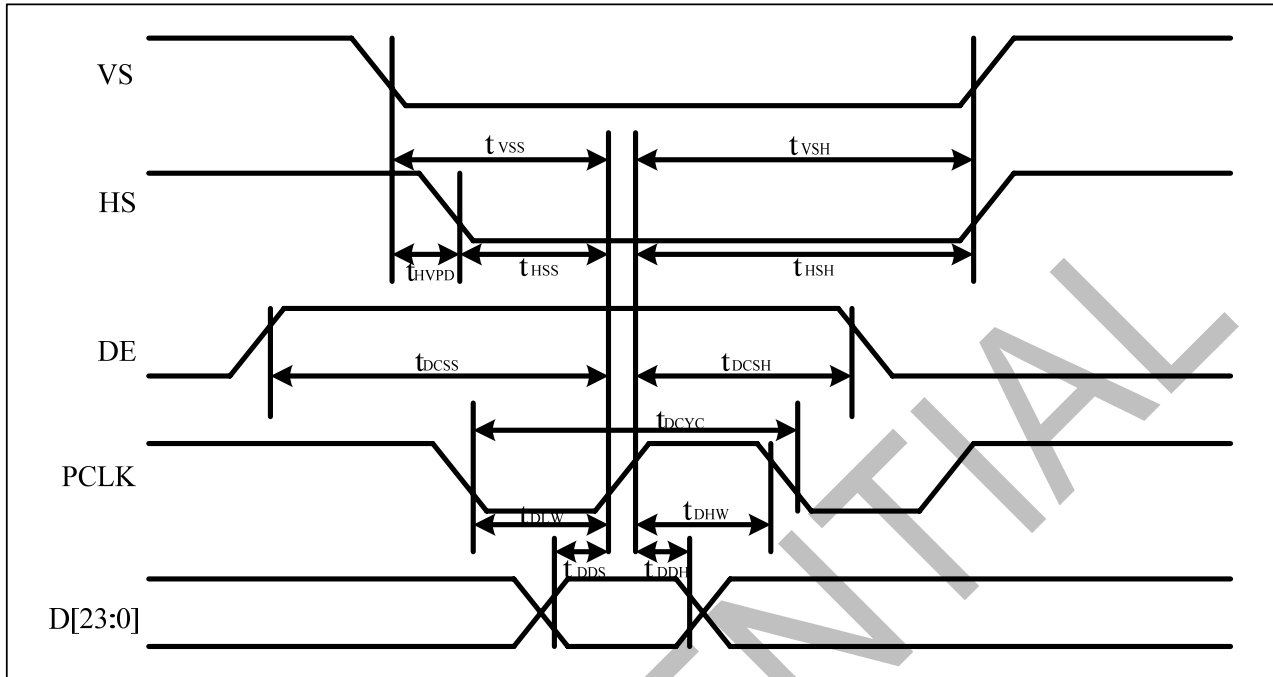

Signal	Symbol	Parameter	MIN	TYP	MAX	Unit
VS	t_{VSS}	VS setup time	10	-	-	ns
	t_{VSH}	VS hold time	10	-	-	ns
HS	t_{HSS}	HS setup time	10	-	-	ns
	t_{HSH}	HS hold time	10	-	-	ns
	t_{HVPD}	HS to VS falling edge	400	-	-	ns
PCLK	t_{DCYC}	PCLK cycle time	33	-	125	ns
	t_{DLW}	PCLK low pulse width	11	-	-	ns
	t_{DHW}	PCLK high pulse width	11	-	-	ns
	f_{DFREQ}	PCLK frequency	8	-	30	MHz
DE	t_{DCSS}	DE setup time	10	-	-	ns
	t_{DCSH}	DE hold time	10	-	-	ns
D[23:0]	t_{DDS}	Data setup time	10	-	-	ns
	t_{DDH}	Data hold time	10	-	-	ns

Note: Logic high and low levels are specified as 20% and 80% of IOVCC for Input signals.

Note: $T_a = -30$ to 70 °C, IOVCC=1.65V to 3.3V, VCI=2.5V to 4.8V, GND=0V

9.6.5 DSI Timing Characteristics

HS Data Transmission Burst

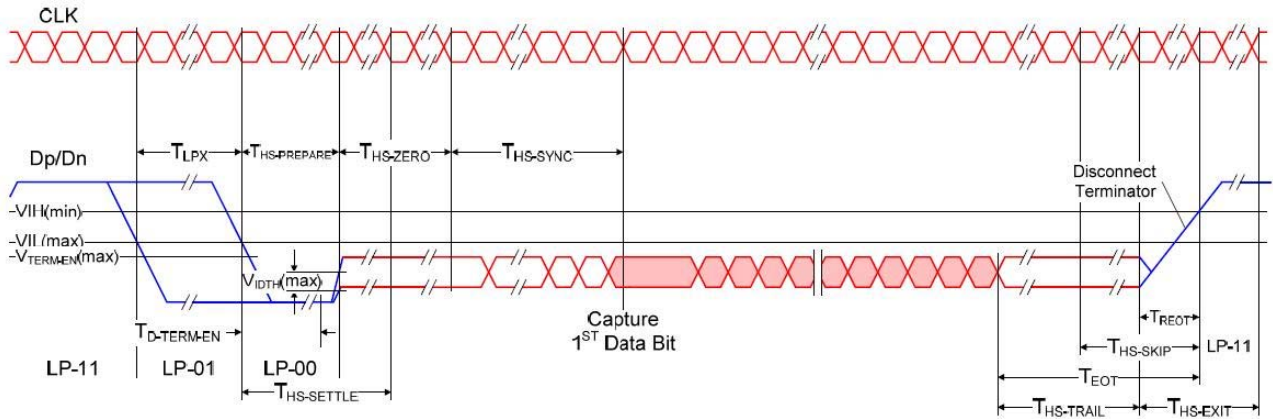

➤ HS clock transmission

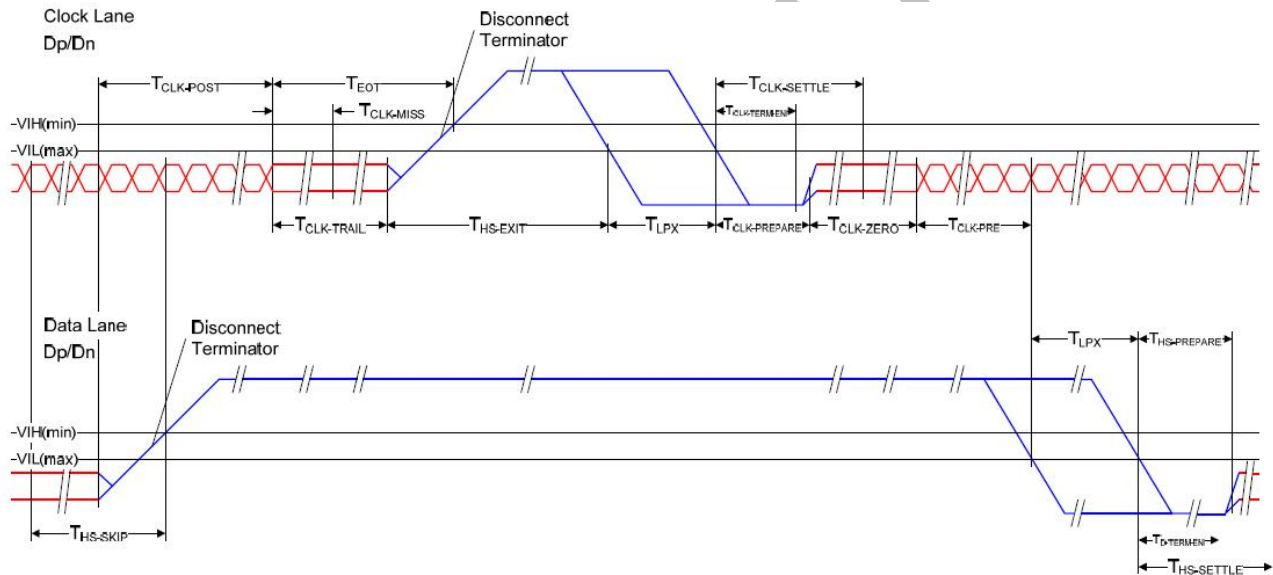

➤ Turnaround Procedure

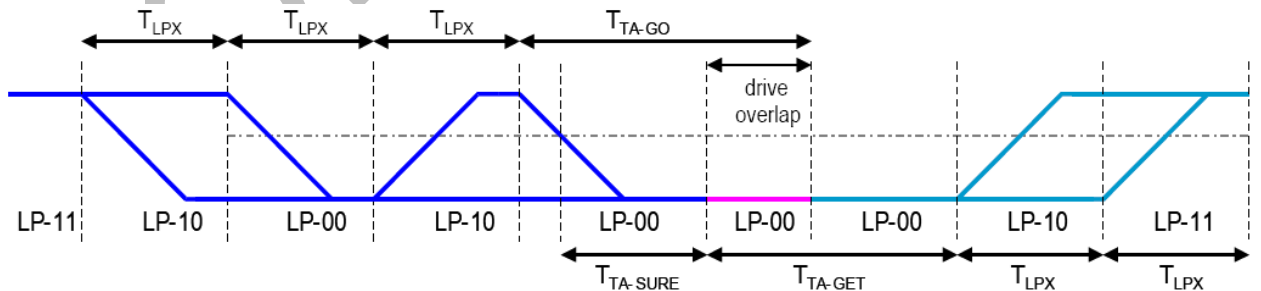

Timing Parameters:

Parameter	Description	Min	Typ	Max	Unit	Notes
$T_{HS-PREPARE}$	Time that the transmitter drives the Data Lane LP-00 Line state immediately before the HS-0 Line state starting the HS transmission	$40\text{ ns} + 4*UI$		$85\text{ ns} + 6*UI$	ns	5
$T_{HS-PREPARE} + T_{HS-ZERO}$	$T_{HS-PREPARE}$ + time that the transmitter drives the HS-0 state prior to transmitting the Sync sequence.	$145\text{ ns} + 10*UI$			ns	5
$T_{HS-SETTLE}$	Time interval during which the HS receiver shall ignore any Data Lane HS transitions, starting from the beginning of $T_{HS-PREPARE}$.	$85\text{ ns} + 6*UI$		$145\text{ ns} + 10*UI$	ns	6
$T_{HS-SKIP}$	Time interval during which the HS-RX should ignore any transitions on the Data Lane, following a HS burst. The end point of the interval is defined as the beginning of the LP-11 state following the HS burst.	40		$55\text{ ns} + 4*UI$	ns	6
$T_{HS-TRAIL}$	Time that the transmitter drives the flipped differential state after last payload data bit of a HS transmission burst	$\max(n*8*UI, 60\text{ ns} + n*4*UI)$			ns	2, 3, 5
T_{DNT}	See section 5.11.	100			μs	5
T_{LPX}	Transmitted length of any Low-Power state period	50			ns	4, 5
Ratio T_{LPX}	Ratio of $T_{LPX(MASTER)}/T_{LPX(SLAVE)}$ between Master and Slave side	2/3		3/2		
T_{TA-GET}	Time that the new transmitter drives the Bridge state (LP-00) after accepting control during a Link Turnaround.	$5*T_{LPX}$			ns	5
T_{TA-GO}	Time that the transmitter drives the Bridge state (LP-00) before releasing control during a Link Turnaround.	$4*T_{LPX}$			ns	5
$T_{TA-SURE}$	Time that the new transmitter waits after the LP-10 state before transmitting the Bridge state (LP-00) during a Link Turnaround.	T_{LPX}		$2*T_{LPX}$	ns	5
T_{WAKEUP}	Time that a transmitter drives a Mark-1 state prior to a Stop state in order to initiate an exit from ULPS.	1			ms	5

Parameter	Description	Min	Typ	Max	Unit	Notes
$T_{CLK-MISS}$	Timeout for receiver to detect absence of Clock transitions and disable the Clock Lane HS-RX.			60	ns	1, 6
$T_{CLK-POST}$	Time that the transmitter continues to send HS clock after the last associated Data Lane has transitioned to LP Mode. Interval is defined as the period from the end of $T_{HS-TRAIL}$ to the beginning of $T_{CLK-TRAIL}$.	$60\text{ ns} + 52*UI$			ns	5
$T_{CLK-PRE}$	Time that the HS clock shall be driven by the transmitter prior to any associated Data Lane beginning the transition from LP to HS mode.	8			UI	5
$T_{CLK-PREPARE}$	Time that the transmitter drives the Clock Lane LP-00 Line state immediately before the HS-0 Line state starting the HS transmission.	38		95	ns	5
$T_{CLK-SETTLE}$	Time interval during which the HS receiver shall ignore any Clock Lane HS transitions, starting from the beginning of $T_{CLK-PREPARE}$.	95		300	ns	6
$T_{CLK-TERM-EN}$	Time for the Clock Lane receiver to enable the HS line termination, starting from the time point when Dn crosses $V_{IL,MAX}$.			38	ns	6
$T_{CLK-TRAIL}$	Time that the transmitter drives the HS-0 state after the last payload clock bit of a HS transmission burst.	60			ns	5
$T_{CLK-PREPARE} + T_{CLK-ZERO}$	$T_{CLK-PREPARE}$ + time that the transmitter drives the HS-0 state prior to starting the Clock.	300			ns	5
$T_{D-TERM-EN}$	Time for the Data Lane receiver to enable the HS line termination, starting from the time point when Dn crosses $V_{IL,MAX}$.			$35\text{ ns} + 4*UI$		6
T_{EOT}	Transmitted time interval from the start of $T_{HS-TRAIL}$ or $T_{CLK-TRAIL}$, to the start of the LP-11 state following a HS burst.			$105\text{ ns} + n*12*UI$		3, 5
$T_{HS-EXIT}$	Time that the transmitter drives LP-11 following a HS burst.	100			ns	5

NOTE:

1. The minimum value depends on the bit rate. Implementations should ensure proper operation for all the supported bit rates.
2. If $a > b$ then $\max(a, b) = a$ otherwise $\max(a, b) = b$
3. Where $n = 1$ for Forward-direction HS mode and $n = 4$ for Reverse-direction HS mode
4. TLPX is an internal state machine timing reference. Externally measured values may differ slightly from the specified values due to asymmetrical rise and fall times.
5. Transmitter-specific parameter
6. Receiver-specific parameter

CONFIDENTIAL

Parameter	Description		Min	Nom	Max	Units	Notes
T _{RLP} /T _{FLP}	15%-85% rise time and fall time				25	ns	1
T _{REOT}	30%-85% rise time and fall time				35	ns	1, 5, 6
T _{LP-PULSE-TX}	Pulse width of the LP exclusive-OR clock	First LP exclusive-OR clock pulse after Stop state or last pulse before Stop state	40			ns	4
		All other pulses	20			ns	4
T _{LP-PER-TX}	Period of the LP exclusive-OR clock		90			ns	
δV/δt _{SR}	Slew rate @ C _{LOAD} = 0pF				500	mV/ns	1, 3, 7, 8
	Slew rate @ C _{LOAD} = 5pF				300	mV/ns	1, 3, 7, 8
	Slew rate @ C _{LOAD} = 20pF				250	mV/ns	1, 3, 7, 8
	Slew rate @ C _{LOAD} = 70pF				150	mV/ns	1, 3, 7, 8
	Slew rate @ C _{LOAD} = 0 to 70pF (Falling Edge Only)		30			mV/ns	1, 2, 3
	Slew rate @ C _{LOAD} = 0 to 70pF (Rising Edge Only)		30			mV/ns	1, 3, 9
	Slew rate @ C _{LOAD} = 0 to 70pF (Rising Edge Only)		30 – 0.075 * (V _{O,INST} – 700)			mV/ns	1, 10, 11
C _{LOAD}	Load capacitance		0		70	pF	1

NOTE:

- CLOAD includes the low-frequency equivalent transmission line capacitance. The capacitance of TX and RX are assumed to always be <10pF. The distributed line capacitance can be up to 50pF for a transmission line with 2ns delay.
- When the output voltage is between 400 mV and 930 mV.
- Measured as average across any 50 mV segment of the output signal transition.
- This parameter value can be lower than TLPX due to differences in rise vs. fall signal slopes and trip levels and mismatches between Dp and Dn LP transmitters. Any LP exclusive-OR pulse observed during HS EoT (transition from HS level to LP-11) is glitch behavior as described in section 8.2.2.
- The rise-time of TREOT starts from the HS common-level at the moment the differential amplitude drops below 70mV, due to stopping the differential drive.
- With an additional load capacitance CCM between 0 and 60pF on the termination center tap at RX side of the Lane.

7. This value represents a corner point in a piecewise linear curve.
8. When the output voltage is in the range specified by VPIN(absmax).
9. When the output voltage is between 400 mV and 700 mV.
10. Where $V_{O,INST}$ is the instantaneous output voltage, VDP or VDN, in millivolts.
11. When the output voltage is between 700 mV and 930 mV.

CONFIDENTIAL

9.6.6 MDDI Timing Characteristics

(VSS=VSSI=DVSS=0V, VDDI=1.65V to 3.3V, VDD=2.3V to 4.8V, Ta = -30 to 70°C)

Signal	Symbol	Parameter	MIN	TYP	MAX	Unit
MDDI_STB_P/M MDDI_DATA_P/M	1/Tbit	Data transfer rate	-	384	450	Mbps
MDDI_STB_P/M MDDI_DATA_P/M	Tskew-pair	Differential transfer input skew	-	-	0.05	ns
MDDI_STB_P/M MDDI_DATA_P/M	Tskew-data	Data/Strobe input skew	-	-	0.3	ns

Note) MDDI_DATA_P/M = MDDI_DATA0_P/M and MDDI_DATA1_P/M.

Skew between MDDI positive and negative signal pair

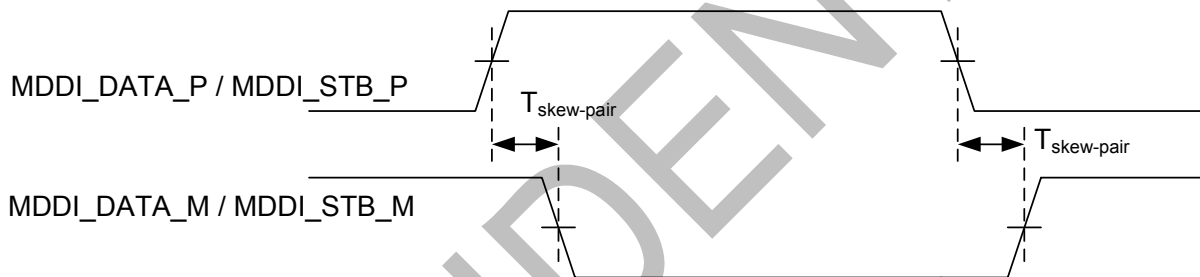

Skew between MDDI_DATA_P/N and MDDI_STB_P/M

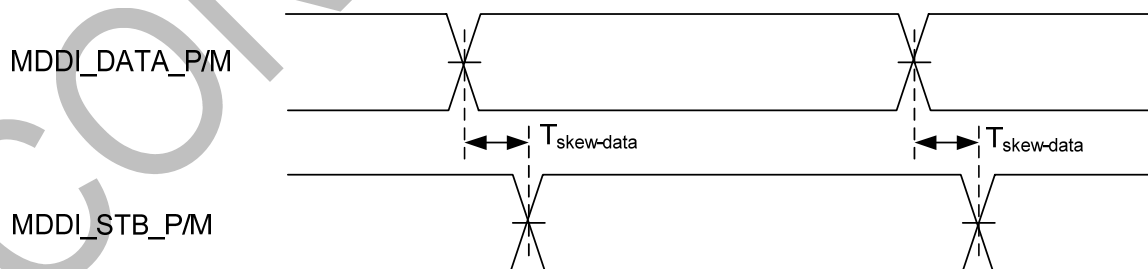

9.6.7 Reset Timing

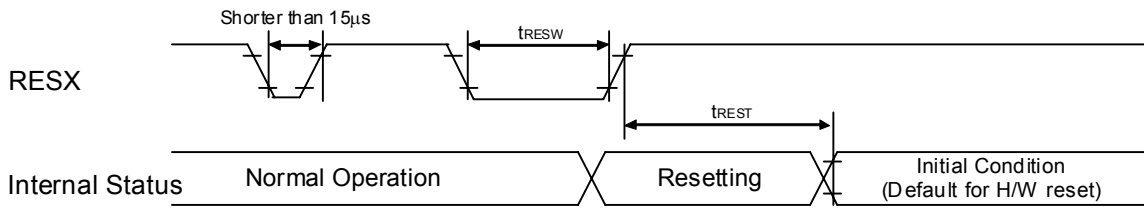

Reset input timing:

IOVCC=1.65 to 3.6V, VCI=2.5 to 3.6V, AGND=DGND=0V, Ta=-40 to 85°C

Symbol	Parameter	Related Pins	MIN	TYP	MAX	Note	Unit
t_{RESW}	*1) Reset low pulse width	RESX	15	-	-	-	μs
t_{REST}	*2) Reset complete time	-	-	-	5	When reset applied during Sleep in mode	ms
		-	-	-	120	When reset applied during Sleep out mode	ms

Note 1) Spike due to an electrostatic discharge on RESX line does not cause irregular system reset according to the table below.

RESX Pulse	Action
Shorter than $5\mu s$	Reset Rejected
Longer than $15\mu s$	Reset
Between $5\mu s$ and $15\mu s$	Reset starts (It depends on voltage and temperature condition.)

Note 2. During the resetting period, the display will be blanked (The display is entering blanking sequence, which maximum time is 120 ms, when Reset Starts in Sleep Out –mode. The display remains the blank state in Sleep In –mode) and then return to Default condition for H/W reset.

Note 3. During Reset Complete Time, data in OTP will be latched to internal register during this period. This loading is done every time when there is H/W reset complete time (t_{REST}) within 5ms after a rising edge of RESX.

Note 4. Spike Rejection also applies during a valid reset pulse as shown below:

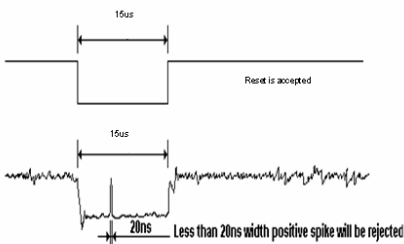

Note 5. It is necessary to wait 5msec after releasing RESX before sending commands. Also Sleep Out command cannot be sent for 120msec.