

# High Performance 2A and 3A LDOs

## ISL80102, ISL80103

The ISL80102 and ISL80103 are low voltage, high-current, single output LDOs specified for 2A and 3A output current, respectively. These parts operate from input voltages of 2.2V to 6V and are capable of providing output voltages of 0.8V to 5V on the adjustable  $V_{OUT}$  versions. Fixed output voltage options available in 0.8V, 1.2V, 1.5V, 1.8V, 2.5V, 3.3V and 5V. Other custom voltage options available upon request.

For applications that demand in-rush current less than current limit, an external capacitor on the in-rush set pin provides adjustment. The ENABLE feature allows the part to be placed into a low quiescent current shutdown mode. Sub-micron CMOS process is utilized for this product family to deliver the best in class analog performance and overall value.

These CMOS LDOs will consume significantly lower quiescent current as a function of load over bipolar LDOs, which translates into higher efficiency and the ability to consider packages with smaller footprints. Quiescent current is modestly compromised to enable a leading class fast load transient response, and hence a lower total AC regulation band for an LDO in this category.

## Pin Configuration

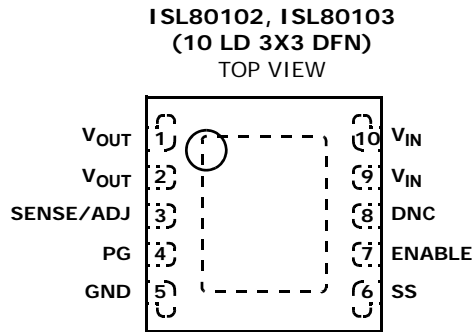

## Features

- 0.5% initial  $V_{OUT}$  Accuracy
- Designed for 2.2V to 6V Input Supply
- $\pm 1.8\%$  Guaranteed  $V_{OUT}$  Accuracy for Junction Temperature Range from  $-40^{\circ}\text{C}$  to  $+125^{\circ}\text{C}$
- 185mV Dropout @ 3A, 125mV Dropout @ 2A
- Fast Load Transient Response
- Rated Output Current Options of 2A and 3A
- Adjustable In-Rush Current Limiting
- Fixed and Adjustable  $V_{OUT}$  Options Available
- 65dB Typical PSRR
- Output Noise of  $100\mu\text{V}_{\text{RMS}}$  between 300Hz to 300kHz
- PG Feature
- 900mV Enable Input Threshold
- Short-Circuit Current Protection
- 1A Peak Reverse Current
- Over-Temperature Shutdown
- Any Cap Stable with Minimum  $10\mu\text{F}$  Ceramic
- Available in a 10 Ld DFN Package and soon to follow TO220-5, TO263-5 and SOT223-5 (1A and 2A versions)
- Pb-Free (RoHS Compliant)

## Applications\* (see page 15)

- DSP, FPGA and  $\mu\text{P}$  Core Power Supplies
- Noise-Sensitive Instrumentation Systems
- Post Regulation of Switched Mode Power Supplies
- Industrial Systems
- Medical Equipment
- Telecommunications and Networking Equipment
- Servers
- Hard Disk Drives (HD/HDD)

## Pin Descriptions

PIN NUMBER	PIN NAME	DESCRIPTION
1, 2	V <sub>OUT</sub>	Output voltage pin.
3	SENSE/ADJ	Remote voltage sense for internally fixed V <sub>OUT</sub> options. ADJ pin for externally set V <sub>OUT</sub> .
4	PG	V <sub>OUT</sub> in regulation signal. Logic low defines when V <sub>OUT</sub> is not in regulation. Must be grounded if not used.
5	GND	GND pin.
6	SS	External cap controls in-rush current.
7	ENABLE	V <sub>IN</sub> independent chip enable. TTL and CMOS compatible.
8	DNC	Do not connect this pin to ground or supply. Leave floating.
9, 10	V <sub>IN</sub>	Input supply pin.
EPAD		Must be soldered directly to GND plane

## Block Diagram

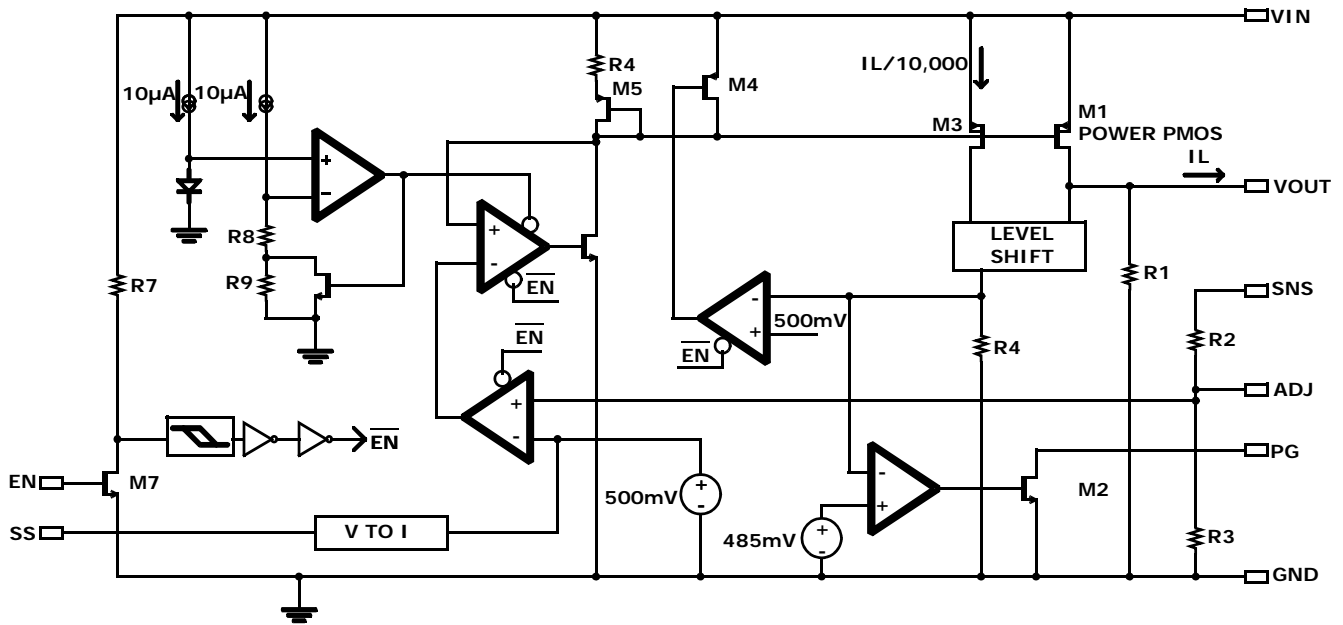

Typical Applications

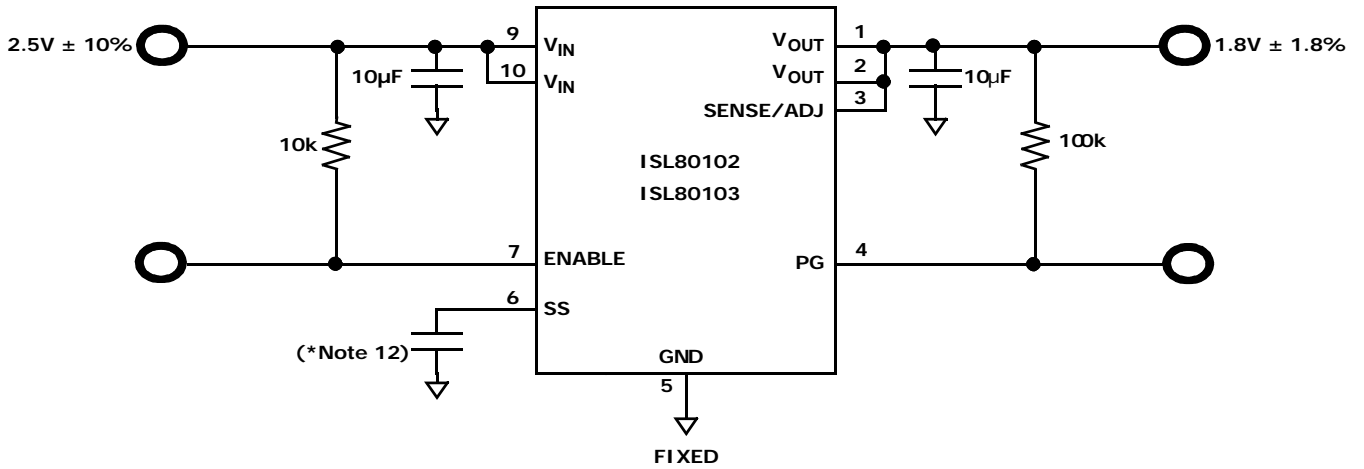

FIGURE 1.

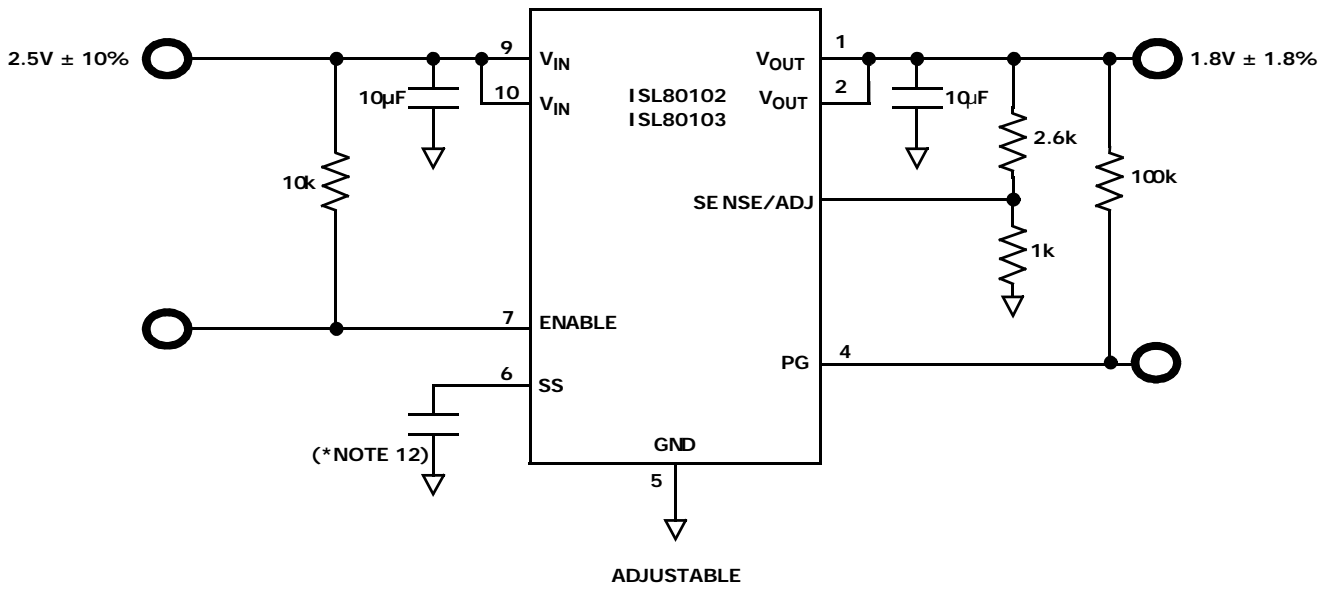

FIGURE 2.

## Ordering Information

PART NUMBER	PART MARKING	V <sub>OUT</sub> VOLTAGE (Note 4)	TEMP. RANGE (°C)	PACKAGE (Pb-Free)	PKG DWG. #
ISL80102IRAJZ (Notes 1, 3)	DZJA	ADJ	-40 to +125	10 Ld 3x3 DFN	L10.3x3
ISL80102IR08Z (Notes 1, 3)	DZKA	0.8V	-40 to +125	10 Ld 3x3 DFN	L10.3x3
ISL80102IR12Z (Notes 1, 3)	DZLA	1.2V	-40 to +125	10 Ld 3x3 DFN	L10.3x3
ISL80102IR15Z (Notes 1, 3)	DZMA	1.5V	-40 to +125	10 Ld 3x3 DFN	L10.3x3
ISL80102IR18Z (Notes 1, 3)	DZNA	1.8V	-40 to +125	10 Ld 3x3 DFN	L10.3x3
ISL80102IR25Z (Notes 1, 3)	DZPA	2.5V	-40 to +125	10 Ld 3x3 DFN	L10.3x3
ISL80102IR33Z (Notes 1, 3)	DZRA	3.3V	-40 to +125	10 Ld 3x3 DFN	L10.3x3
ISL80102IR50Z (Notes 1, 3)	DZSA	5.0V	-40 to +125	10 Ld 3x3 DFN	L10.3x3
ISL80103IRAJZ (Notes 1, 3)	DZAA	ADJ	-40 to +125	10 Ld 3x3 DFN	L10.3x3
ISL80103IR08Z (Notes 1, 3)	DZBA	0.8V	-40 to +125	10 Ld 3x3 DFN	L10.3x3
ISL80103IR12Z (Notes 1, 3)	DZCA	1.2V	-40 to +125	10 Ld 3x3 DFN	L10.3x3
ISL80103IR15Z (Note 3)	DZDA	1.5V	-40 to +125	10 Ld 3x3 DFN	L10.3x3
ISL80103IR15Z-T (Notes 2, 3)	DZDA	1.5V	-40 to +125	10 Ld 3x3 DFN Tape and Reel	L10.3x3
ISL80103IR18Z (Notes 1, 3)	DZEA	1.8V	-40 to +125	10 Ld 3x3 DFN	L10.3x3
ISL80103IR25Z (Notes 1, 3)	DZFA	2.5V	-40 to +125	10 Ld 3x3 DFN	L10.3x3
ISL80103IR33Z (Note 3)	DZGA	3.3V	-40 to +125	10 Ld 3x3 DFN	L10.3x3
ISL80103IR33Z-T (Notes 2, 3)	DZGA	3.3V	-40 to +125	10 Ld 3x3 DFN Tape and Reel	L10.3x3
ISL80103IR50Z (Note 3)	DZHA	5.0V	-40 to +125	10 Ld 3x3 DFN	L10.3x3
ISL80103IR50Z-T (Notes 2, 3)	DZHA	5.0V	-40 to +125	10 Ld 3x3 DFN Tape and Reel	L10.3x3

## NOTES:

1. Add "-T" or "-TK" suffix for tape and reel. Please refer to [TB347](#) for details on reel specifications.
2. Please refer to [TB347](#) for details on reel specifications.
3. These Intersil Pb-free plastic packaged products employ special Pb-free material sets, molding compounds/die attach materials, and 100% matte tin plate plus anneal (e3 termination finish, which is RoHS compliant and compatible with both SnPb and Pb-free soldering operations). Intersil Pb-free products are MSL classified at Pb-free peak reflow temperatures that meet or exceed the Pb-free requirements of IPC/JEDEC J STD-020.
4. For other output voltages, contact Intersil Marketing.
5. For Moisture Sensitivity Level (MSL), please see device information page for [ISL80102](#), [ISL80103](#). For more information on MSL please see techbrief [TB363](#).

# ISL80102, ISL80103

## Absolute Maximum Ratings (Note 8)

V <sub>IN</sub> relative to GND	-0.3V to +6.5V
V <sub>OUT</sub> relative to GND	-0.3V to +6.5V
PG, ENABLE, SENSE/ADJ, SS	
Relative to GND.	-0.3V to +6.5V

## Recommended Operating Conditions

Junction Temperature Range (T <sub>J</sub> )	-40°C to +125°C
V <sub>IN</sub> relative to GND	2.2V to 6V
V <sub>OUT</sub> range	800mV to 5V
PG, ENABLE, SENSE/ADJ, SS relative to GND	0V to 6V
PG sink current	10mA

## Thermal Information

Thermal Resistance (Typical)	θ <sub>JA</sub> (°C/W)	θ <sub>JC</sub> (°C/W)
10 Ld 3x3 DFN Package (Notes 6, 7)	45	4
Maximum Junction Temperature (Plastic Package)	+150°C	
Storage Temperature Range	-65°C to +150°C	
Pb-Free Reflow Profile	see link below	
	<a href="http://www.intersil.com/pbfree/Pb-FreeReflow.asp">http://www.intersil.com/pbfree/Pb-FreeReflow.asp</a>	

**CAUTION:** Do not operate at or near the maximum ratings listed for extended periods of time. Exposure to such conditions may adversely impact product reliability and result in failures not covered by warranty.

### NOTES:

- θ<sub>JA</sub> is measured in free air with the component mounted on a high effective thermal conductivity test board with "direct attach" features. See Tech Brief TB379.
- For θ<sub>JC</sub>, the "case temp" location is the center of the exposed metal pad on the package underside.
- ABS max voltage rating is defined as the voltage applied for a lifetime average duty cycle above 6V of 1%.

**Electrical Specifications** Unless otherwise noted, all parameters are established over the following specified conditions: V<sub>IN</sub> = V<sub>OUT</sub> + 0.4V, V<sub>OUT</sub> = 1.8V, C<sub>IN</sub> = C<sub>OUT</sub> = 10μF, T<sub>J</sub> = +25°C, I<sub>L</sub> = 0A. Applications must follow thermal guidelines of the package to determine worst case junction temperature. Please refer to "Application Section" on page 7 and Tech Brief TB379.

**Boldface limits apply over the operating temperature range, -40°C to +125°C.** Pulse load techniques used by ATE to ensure T<sub>J</sub> = T<sub>A</sub> defines established limits.

PARAMETER	SYMBOL	TEST CONDITIONS	MIN (Note 9)	TYP	MAX (Note 9)	UNITS
<b>DC CHARACTERISTICS</b>						
DC Output Voltage Accuracy	V <sub>OUT</sub>	V <sub>OUT</sub> Options: 0.8V, 1.2V, 1.5V and 1.8V				
		2.2V < V <sub>IN</sub> < 3.6V; 0A < I <sub>LOAD</sub> < 3A	<b>-1.8</b>	0.5	<b>1.8</b>	%
		V <sub>OUT</sub> Options: 2.5V, 3.3V and 5.0V				
		V <sub>OUT</sub> + 0.4V < V <sub>IN</sub> < 6V; 0A < I <sub>LOAD</sub> < 3A	<b>-1.8</b>	0.5	<b>-1.8</b>	%
Feedback Pin (ADJ option only)	V <sub>FB</sub>	2.2V < V <sub>IN</sub> < 6V, 0A < I <sub>LOAD</sub> < 3A	<b>491</b>	500	<b>509</b>	mV
DC Input Line Regulation	ΔV <sub>OUT</sub> /ΔV <sub>IN</sub>	V <sub>OUT</sub> + 0.4V < V <sub>IN</sub> < 3.6V, V <sub>OUT</sub> = 1.8V		0.1	<b>0.4</b>	%
		V <sub>OUT</sub> + 0.4V < V <sub>IN</sub> < 6V, V <sub>OUT</sub> = 2.5V		0.1	<b>0.8</b>	%
DC Output Load Regulation	ΔV <sub>OUT</sub> /ΔI <sub>OUT</sub> T	0A < I <sub>LOAD</sub> < 3A, All voltage options	<b>-0.8</b>			%
		0A < I <sub>LOAD</sub> < 2A, All voltage options	<b>-0.6</b>			%
Feedback Input Current		V <sub>ADJ</sub> = 0.5V		0.01	<b>1</b>	μA
Ground Pin Current	I <sub>Q</sub>	I <sub>LOAD</sub> = 0A, 2.2V < V <sub>IN</sub> < 6V		7.5	<b>9</b>	mA
		I <sub>LOAD</sub> = 3A, 2.2V < V <sub>IN</sub> < 6V		8.5	<b>12</b>	mA
Ground Pin Current in Shutdown	I <sub>SHDN</sub>	ENABLE Pin = 0.2V, V <sub>IN</sub> = 5V		0.4		μA
		ENABLE Pin = 0.2V, V <sub>IN</sub> = 6V		3.3	<b>16</b>	μA
Dropout Voltage (Note 10)	V <sub>DO</sub>	I <sub>LOAD</sub> = 3A, V <sub>OUT</sub> = 2.5V		120	<b>185</b>	mV
		I <sub>LOAD</sub> = 2A, V <sub>OUT</sub> = 2.5V		81	<b>125</b>	mV
Output Short Circuit Current (3A Version)	ISC	V <sub>OUT</sub> = 0V, V <sub>OUT</sub> + 0.4V < V <sub>IN</sub> < 6V		5.0		A
Output Short Circuit Current (2A Version)		V <sub>OUT</sub> = 0V, V <sub>OUT</sub> + 0.4V < V <sub>IN</sub> < 6V		2.8		A
Thermal Shutdown Temperature	TSD	V <sub>OUT</sub> + 0.4V < V <sub>IN</sub> < 6V		160		°C

# ISL80102, ISL80103

**Electrical Specifications** Unless otherwise noted, all parameters are established over the following specified conditions:  $V_{IN} = V_{OUT} + 0.4V$ ,  $V_{OUT} = 1.8V$ ,  $C_{IN} = C_{OUT} = 10\mu F$ ,  $T_J = +25^\circ C$ ,  $I_L = 0A$ . Applications must follow thermal guidelines of the package to determine worst case junction temperature. Please refer to "Application Section" on page 7 and Tech Brief [TB379](#). **Boldface limits apply over the operating temperature range,  $-40^\circ C$  to  $+125^\circ C$ .** Pulse load techniques used by ATE to ensure  $T_J = T_A$  defines established limits. **(Continued)**

PARAMETER	SYMBOL	TEST CONDITIONS	MIN (Note 9)	TYP	MAX (Note 9)	UNITS
Thermal Shutdown Hysteresis (Rising Threshold)	TSDn	$V_{OUT} + 0.4V < V_{IN} < 6V$		15		$^\circ C$
<b>AC CHARACTERISTICS</b>						
Input Supply Ripple Rejection	PSRR	$f = 1kHz, I_{LOAD} = 1A; V_{IN} = 2.2V$		55		dB
		$f = 120Hz, I_{LOAD} = 1A; V_{IN} = 2.2V$		62		
Output Noise Voltage		$I_{LOAD} = 10mA, BW = 300Hz < f < 300kHz$		100		$\mu V_{RMS}$
<b>ENABLE PIN CHARACTERISTICS</b>						
Turn-on Threshold		$2.2V < V_{IN} < 6V$	<b>0.3</b>	0.8	<b>0.95</b>	V
Hysteresis (rising threshold)		Must be independent of $V_{IN}$ , $2.2V < V_{IN} < 6V$		135		mV
Enable Pin Turn-on Delay		$C_{OUT} = 10\mu F, I_{LOAD} = 1A$		150		$\mu s$
Enable Pin Leakage Current		$V_{IN} = 6V, EN = 3V$			<b>1</b>	$\mu A$
<b>SOFT START CHARACTERISTICS</b>						
In-rush Current Limit Adjust	R <sub>PD</sub>			323		$\Omega$
	I <sub>CHG</sub>		<b>-7</b>	-4.5	<b>-2</b>	$\mu A$
<b>PG PIN CHARACTERISTICS</b>						
$V_{OUT}$ PG Flag Threshold			<b>75</b>	84	<b>92</b>	$\%V_{OUT}$
$V_{OUT}$ PG Flag Hysteresis				4		%
PG Flag Low Voltage		$I_{SINK} = 500\mu A$		47	<b>100</b>	mV
PG Flag Leakage Current		$V_{IN} = 6V, PG = 6V$		0.05	<b>1</b>	$\mu A$

**NOTES:**

- Parameters with MIN and/or MAX limits are 100% tested at  $+25^\circ C$ , unless otherwise specified. Temperature limits established by characterization and are not production tested.
- Dropout is defined by the difference in supply  $V_{IN}$  and  $V_{OUT}$  when the supply produces a 2% drop in  $V_{OUT}$  from its nominal value.
- Electromigration specification defined as lifetime average junction temperature of  $+110^\circ C$  where max rated DC current = lifetime average current.
- Minimum cap on  $V_{IN}$  and  $V_{OUT}$  required for stability.
- Used when large bulk capacitance required on  $V_{OUT}$  for application.

## Application Section

### Input Voltage Requirements

Despite other output voltages offered, this family of LDOs is optimized for a true 2.5V to 1.8V conversion where the input supply can have a tolerance of as much as  $\pm 10\%$  for conditions noted in the “Electrical Specifications” table on page 5. Minimum guaranteed input voltage is 2.2V. However, due to the nature of an LDO,  $V_{IN}$  must be some margin higher than the output voltage plus dropout at the maximum rated current of the application if active filtering (PSRR) is expected from  $V_{IN}$  to  $V_{OUT}$ . The Dropout spec of this family of LDOs has been generously specified in order to allow applications to design for a level of efficiency that can accommodate the smaller outline package for those applications that cannot accommodate the profile of the TO220/263.

### External Capacitor Requirements

#### GENERAL GUIDELINE

External capacitors are required for proper operation. Careful attention must be paid to layout guidelines and selection of capacitor type and value to ensure optimal performance.

#### OUTPUT CAPACITOR

The required minimum output capacitor is  $10\mu\text{F}$  X5R/X7R to ensure stable operation. Lower cost Y5V and Z5U type ceramic capacitors are acceptable if the size of the capacitor is larger to compensate for the significantly lower tolerance over X5R/X7R types (approximately 2x). Additional capacitors of any value in Ceramic, POSCAP or Alum/Tantalum Electrolytic types may be placed in parallel to improve PSRR at higher frequencies and/or load transient AC output voltage tolerances. This minimum capacitor must be connected to  $V_{OUT}$  and Ground pins of the LDO with PCB traces no longer than 0.5cm.

#### INPUT CAPACITOR

The minimum input capacitor required for proper operation is  $10\mu\text{F}$  having a ceramic dielectric. This minimum capacitor must be connected to  $V_{OUT}$  and Ground pins of the LDO with PCB traces no longer than 0.5cm.

### Thermal Fault Protection

In the event the die temperature exceeds typically  $+160^{\circ}\text{C}$ , then the output of the LDO will shut down until the die temperature can cool down to typically  $+145^{\circ}\text{C}$ . The level of power combined with the thermal impedance of the package ( $+50^{\circ}\text{C}/\text{W}$  for DFN) will determine if the junction temperature exceeds the thermal shutdown temperature specified in the “Electrical Specifications” table on page 5 (see thermal packaging guidelines).

### Current Limit Protection

The ISL80102/3 family of LDOs incorporates protection against overcurrent due to any short or overload condition applied to the output pin. The current limit

circuit performs as a constant current source when the output current exceeds the current limit threshold noted in the “Electrical Specifications” table on page 5. If the short or overload condition is removed from  $V_{OUT}$ , then the output returns to normal voltage mode regulation. In the event of an overload condition on the DFN package the LDO will begin to cycle on and off due to the die temperature exceeding thermal fault condition. The TO220/263 package will tolerate higher levels of power dissipation on the die which may never thermal cycle if the heatsink of this larger package can keep the die temperature below the specified typical thermal shutdown temperature.

## Functional Description

### Enable Operation

The Enable turn-on threshold is typically 770mV with a hysteresis of 135mV. The Enable pin doesn't have an internal pull-up or pull-down resistor. As a result, this pin must not be left floating. This pin must be tied to  $V_{IN}$  if it is not used. A  $1\text{k}\Omega$  to  $10\text{k}\Omega$  pull-up resistor will be required for applications that use open collector or open drain outputs to control the Enable pin. The Enable pin may be connected directly to  $V_{IN}$  for applications that are always on.

### Soft-Start Operation

The soft start circuit controls the rate at which the output voltage comes up to regulation at power-up or coming out of a chip disable. A constant current charges an external soft start capacitor. The external capacitor always gets discharged to 0V at start-up or after coming out of a chip disable. The discharge rate is the RC time constant of  $R_{PD}$  and  $C_{SS}$ . The soft-start function effectively limits the amount of in-rush current below the programmed current limit during start-up or an enable sequence to avoid an overcurrent fault condition. This can be an issue for applications that require large, external bulk capacitances on  $V_{OUT}$  where high levels of charging current can be seen for a significant period of time. High in-rush currents can cause  $V_{IN}$  to drop below minimum which could cause  $V_{OUT}$  to shutdown. Figure 3 shows the relationship between in-rush current and  $C_{SS}$  with a  $C_{OUT}$  of  $1000\mu\text{F}$ .

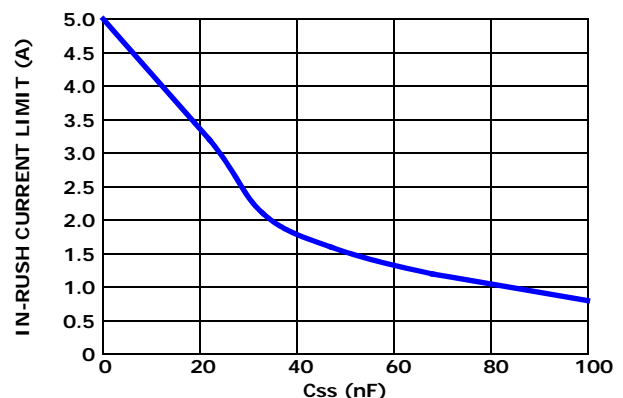

FIGURE 3. IN-RUSH CURRENT vs SOFT-START CAPACITANCE

**Power-Good Operation**

The PGOOD circuit monitors  $V_{OUT}$  and signals a fault condition when  $V_{OUT}$  is below 84% of the nominal output voltage. The PGOOD flag is an open-drain NMOS that can sink 10mA during a fault condition. The PGOOD pin requires an external pull up resistor which is typically connected to the VOUT pin. The PGOOD pin should not be pulled up to a voltage source greater than  $V_{IN}$ . During a fault condition, the PGOOD output is pulled low. The PGOOD fault can be caused by the current limit fault or low input voltage. The PGOOD does not function during thermal shutdown and when the part is disabled.

**Output Voltage Selection**

An external resistor divider is used to scale the output voltage relative to the internal reference voltage. This voltage is then fed back to the error amplifier. The output voltage can be programmed to any level between 0.8V and 5V. An external resistor divider,  $R_1$  and  $R_2$ , is used to set the output voltage as shown in Equation 1. The recommended value for  $R_2$  is 500Ω to 1kΩ.  $R_1$  is then chosen according to Equation 2:

$$V_{OUT} = 0.5V \times \left( \frac{R_1}{R_2} + 1 \right) \tag{EQ. 1}$$

$$R_1 = R_2 \times \left( \frac{V_{OUT}}{0.5V} - 1 \right) \tag{EQ. 2}$$

**Power Dissipation**

The junction temperature must not exceed the range specified in the Recommended Operating Conditions. The power dissipation can be calculated by using Equation 3:

$$P_D = (V_{IN} - V_{OUT}) \times I_{OUT} + V_{IN} \times I_{GND} \tag{EQ. 3}$$

The maximum allowed junction temperature,  $T_{J(MAX)}$  and the maximum expected ambient temperature,  $T_{A(MAX)}$  will determine the maximum allowed junction temperature rise ( $\Delta T_J$ ) as shown in Equation 4:

$$\Delta T_J = T_{J(MAX)} - T_{A(MAX)} \tag{EQ. 4}$$

To calculate the maximum ambient operating temperature, use the junction-to-ambient thermal resistance ( $\theta_{JA}$ ) for the DFN package with Equation 5:

$$P_{D(MAX)} = (T_{J(MAX)} - T_A) / \theta_{JA} \tag{EQ. 5}$$

Substitute  $P_D$  for  $P_{D(MAX)}$  and the maximum ambient operating temperature can be found by solving for  $T_A$  using Equation 6:

$$T_A = T_{JMAX} - P_{D(MAX)} \times \theta_{JA} \tag{EQ. 6}$$

**Heatsinking The DFN Package**

The DFN package uses the copper area on the PCB as a heat-sink. The EPAD of this package must be soldered to the copper plane (GND plane) for heat sinking. Figure 4 shows a curve for the  $\theta_{JA}$  of the DFN package for different copper area sizes.

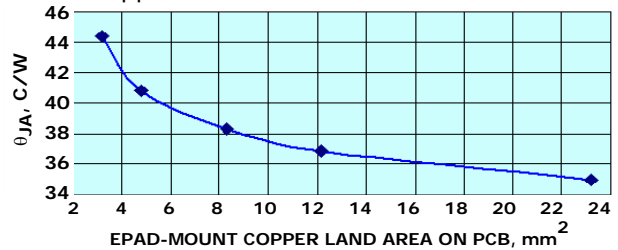

**FIGURE 4. 3mmx3mm-10 Pin DFN ON 4-LAYER PCB WITH THERMAL VIAS  $\theta_{JA}$  vs EPAD-MOUNT COPPER LAND AREA ON PCB**



## Typical Operating Performance

Unless otherwise noted:  $V_{IN} = 2.2V$ ,  $V_{OUT} = 1.8V$ ,  $C_{IN} = C_{OUT} = 10\mu F$ ,  $T_J = +25^\circ C$ ,  $I_L = 0A$ .

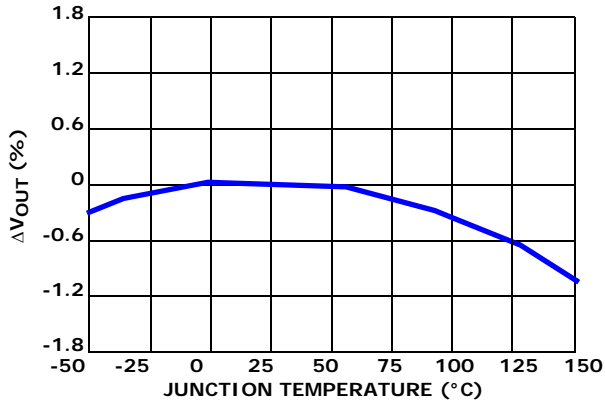

FIGURE 5. OUTPUT VOLTAGE vs TEMPERATURE

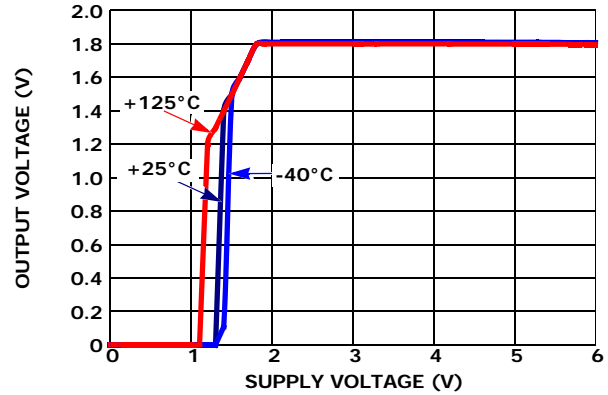

FIGURE 6. OUTPUT VOLTAGE vs SUPPLY VOLTAGE

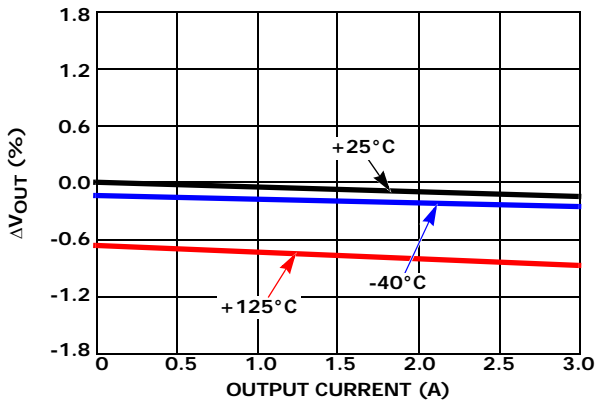

FIGURE 7. OUTPUT VOLTAGE vs OUTPUT CURRENT

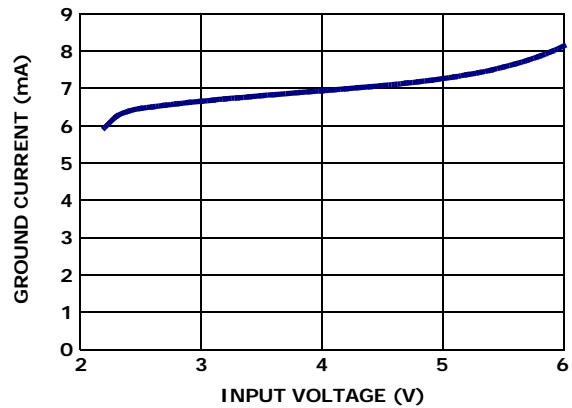

FIGURE 8. GROUND CURRENT vs SUPPLY VOLTAGE

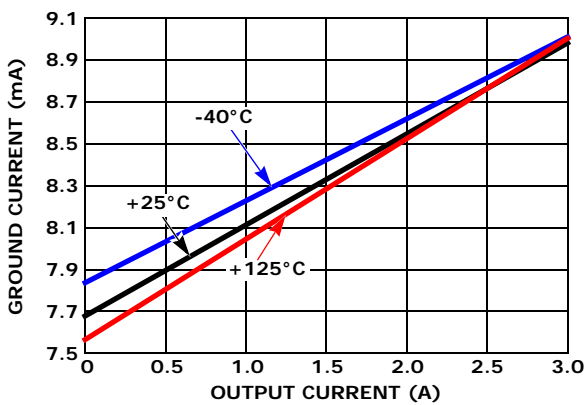

FIGURE 9. GROUND CURRENT vs OUTPUT CURRENT

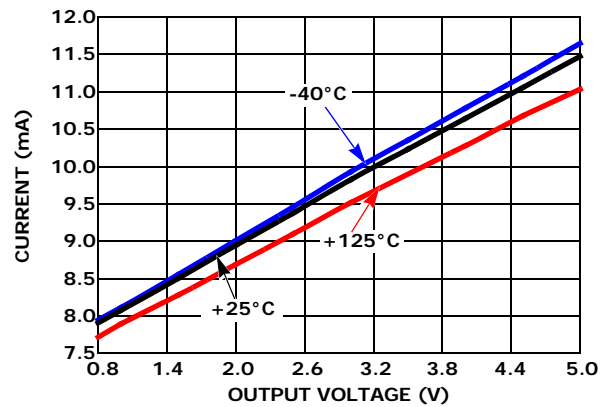

FIGURE 10. GROUND CURRENT vs OUTPUT VOLTAGE

## Typical Operating Performance

Unless otherwise noted:  $V_{IN} = 2.2V$ ,  $V_{OUT} = 1.8V$ ,  $C_{IN} = C_{OUT} = 10\mu F$ ,  $T_J = +25^\circ C$ ,  $I_L = 0A$ . (Continued)

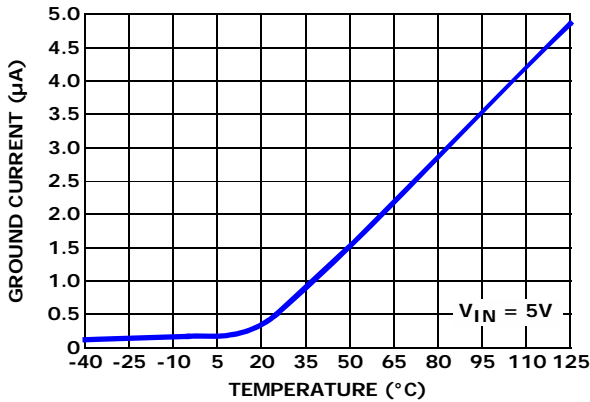

FIGURE 11. SHUTDOWN CURRENT vs TEMPERATURE

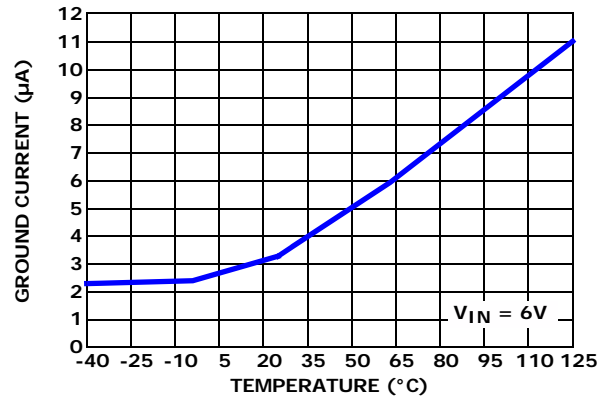

FIGURE 12. SHUTDOWN CURRENT vs TEMPERATURE

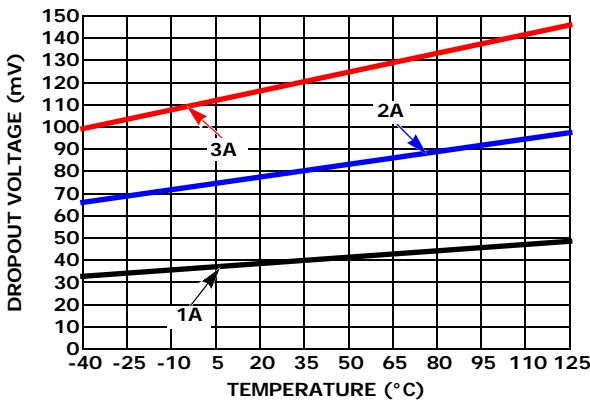

FIGURE 13. DROPOUT VOLTAGE vs TEMPERATURE

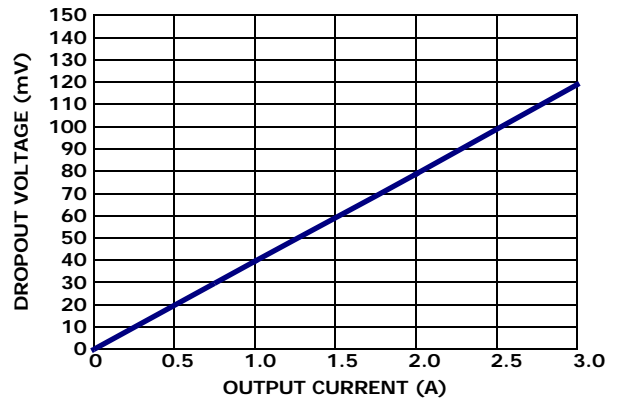

FIGURE 14. DROPOUT VOLTAGE vs OUTPUT CURRENT

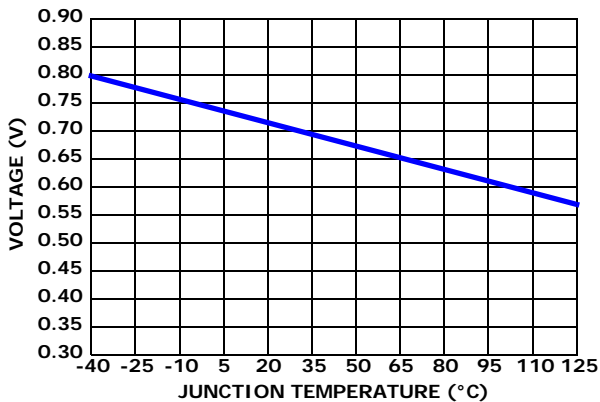

FIGURE 15. ENABLE THRESHOLD VOLTAGE vs TEMPERATURE

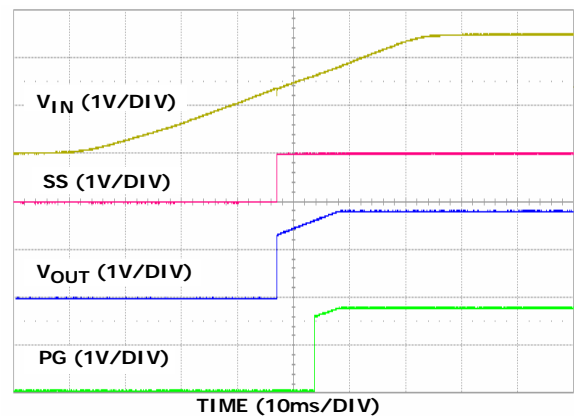

FIGURE 16. POWER-UP ( $V_{IN} = 2.2V$ )

## Typical Operating Performance

Unless otherwise noted:  $V_{IN} = 2.2V$ ,  $V_{OUT} = 1.8V$ ,  $C_{IN} = C_{OUT} = 10\mu F$ ,  $T_J = +25^\circ C$ ,  $I_L = 0A$ . (Continued)

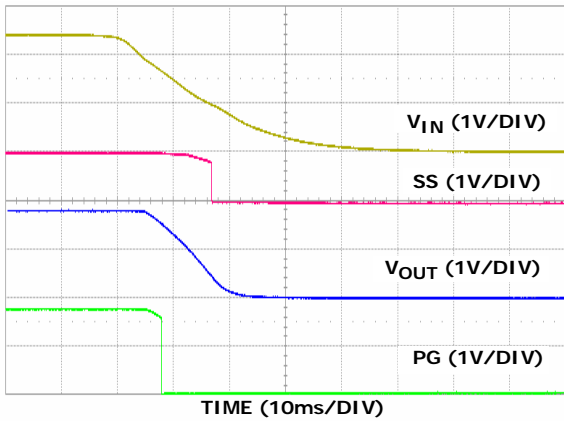

FIGURE 17. POWER-DOWN ( $V_{IN} = 2.2V$ )

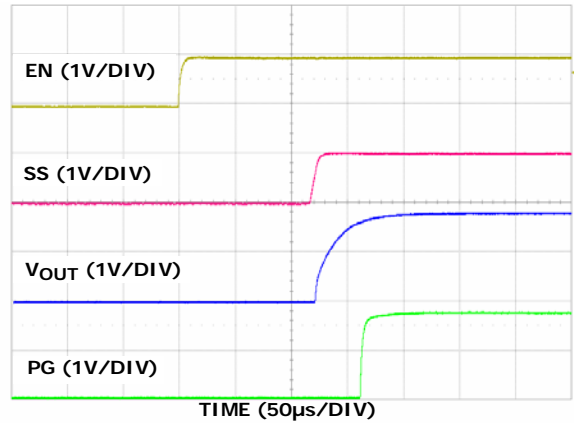

FIGURE 18. ENABLE START-UP

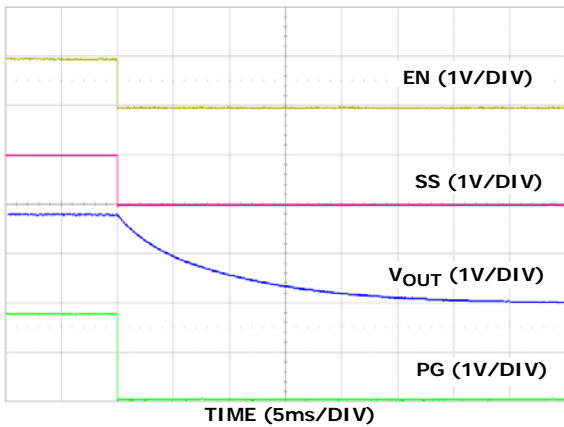

FIGURE 19. ENABLE SHUTDOWN

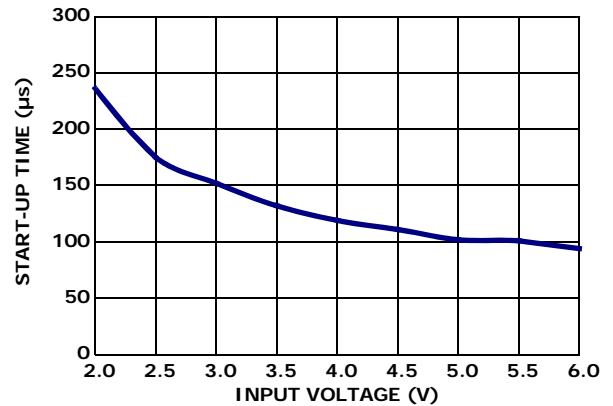

FIGURE 20. START-UP TIME vs SUPPLY VOLTAGE

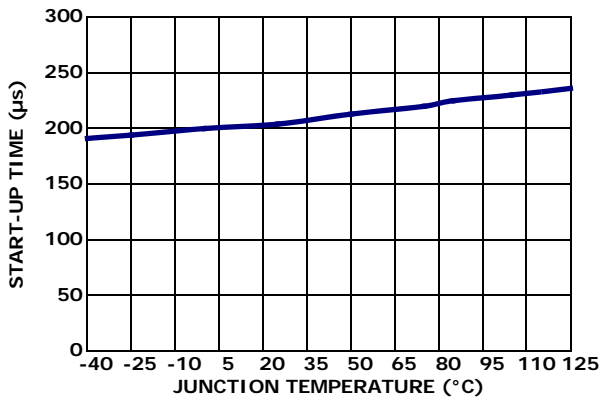

FIGURE 21. START-UP TIME vs TEMPERATURE

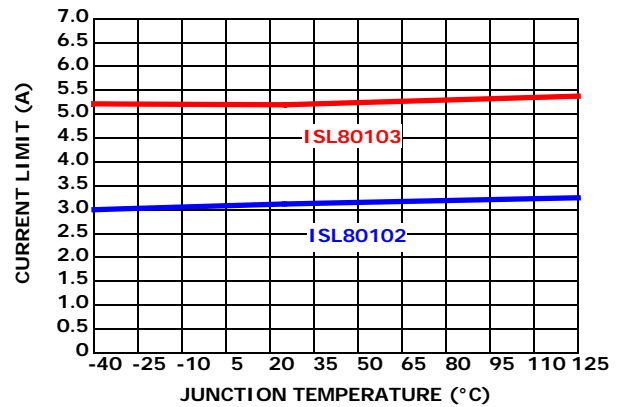

FIGURE 22. CURRENT LIMIT vs TEMPERATURE

## Typical Operating Performance

Unless otherwise noted:  $V_{IN} = 2.2V$ ,  $V_{OUT} = 1.8V$ ,  $C_{IN} = C_{OUT} = 10\mu F$ ,  $T_J = +25^\circ C$ ,  $I_L = 0A$ . (Continued)

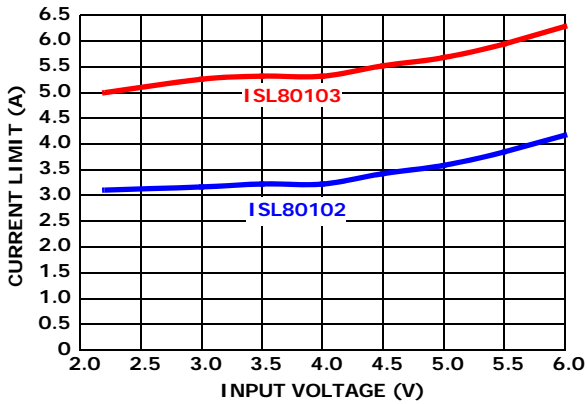

FIGURE 23. CURRENT LIMIT vs SUPPLY VOLTAGE

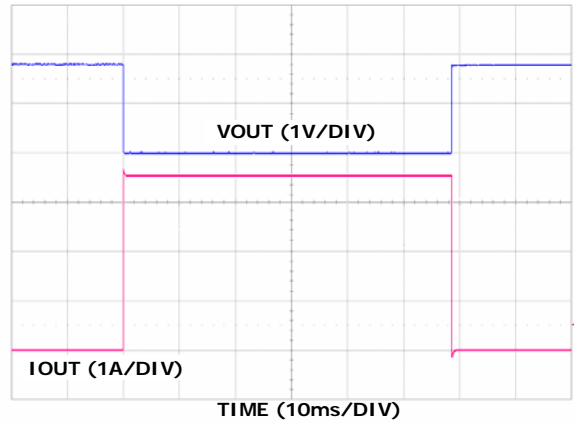

FIGURE 24. CURRENT LIMIT RESPONSE (ISL80102)

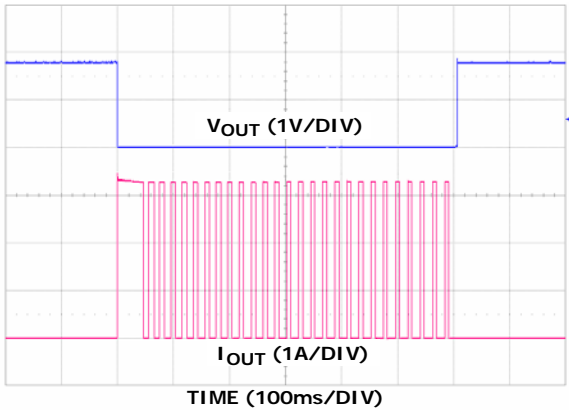

FIGURE 25. THERMAL CYCLING (ISL80102)

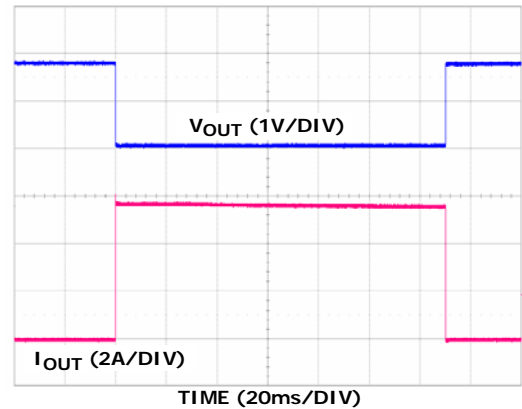

FIGURE 26. CURRENT LIMIT RESPONSE (ISL80103)

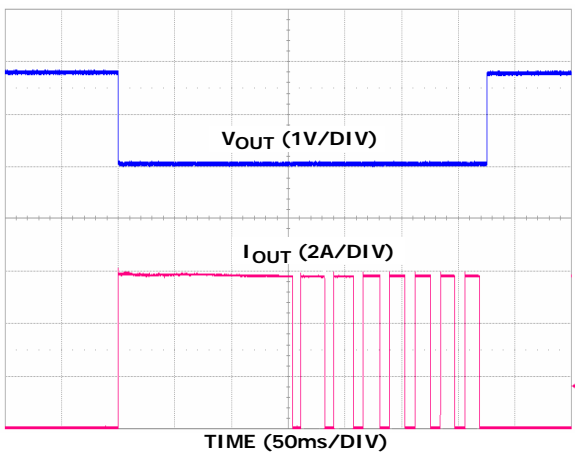

FIGURE 27. THERMAL CYCLING (ISL80103)

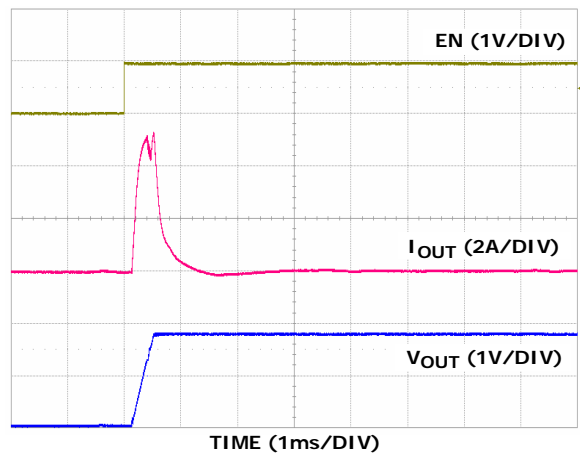

FIGURE 28. IN-RUSH CURRENT WITH NO SOFT-START CAPACITOR,  $C_{OUT} = 1000\mu F$

## Typical Operating Performance

Unless otherwise noted:  $V_{IN} = 2.2V$ ,  $V_{OUT} = 1.8V$ ,  $C_{IN} = C_{OUT} = 10\mu F$ ,  $T_J = +25^\circ C$ ,  $I_L = 0A$ . (Continued)

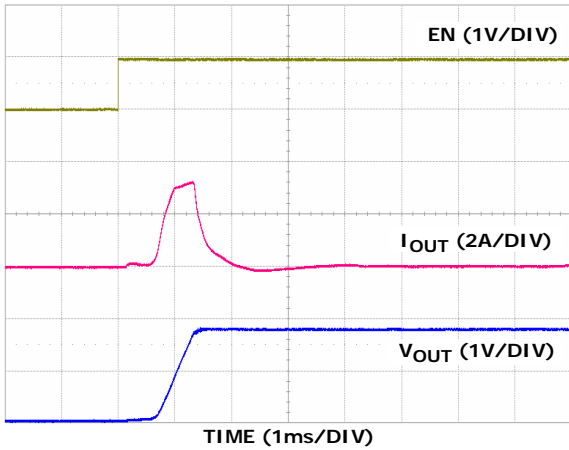

FIGURE 29. IN-RUSH WITH 22nF SOFT-START CAPACITOR,  $C_{OUT} = 1000\mu F$

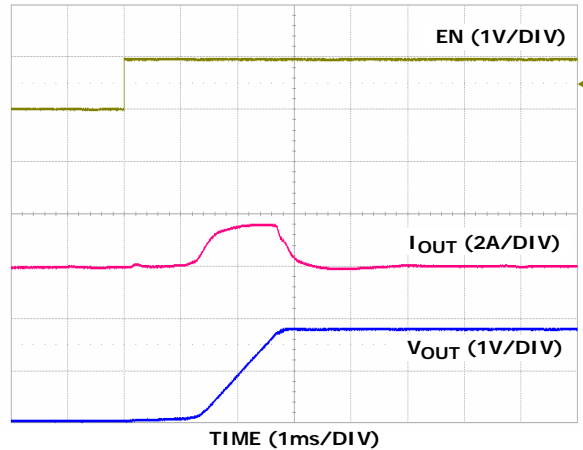

FIGURE 30. IN-RUSH WITH 47nF SOFT-START CAPACITOR,  $C_{OUT} = 1000\mu F$

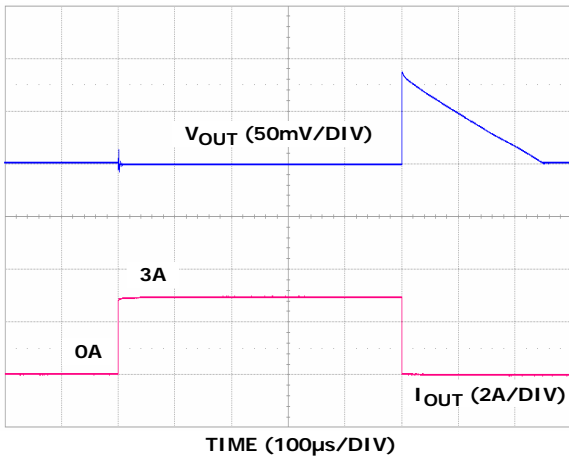

FIGURE 31. LOAD TRANSIENT 0A TO 3A,  $C_{OUT} = 10\mu F$  CERAMIC

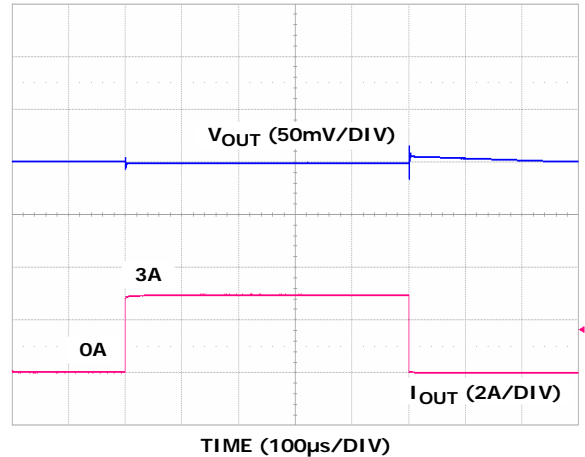

FIGURE 32. LOAD TRANSIENT 0A TO 3A,  $C_{OUT} = 10\mu F$  CERAMIC + 100µF OSCON

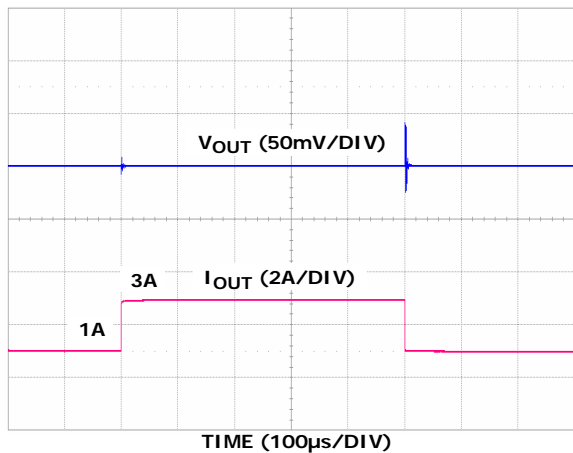

FIGURE 33. LOAD TRANSIENT 1A TO 3A,  $C_{OUT} = 10\mu F$  CERAMIC

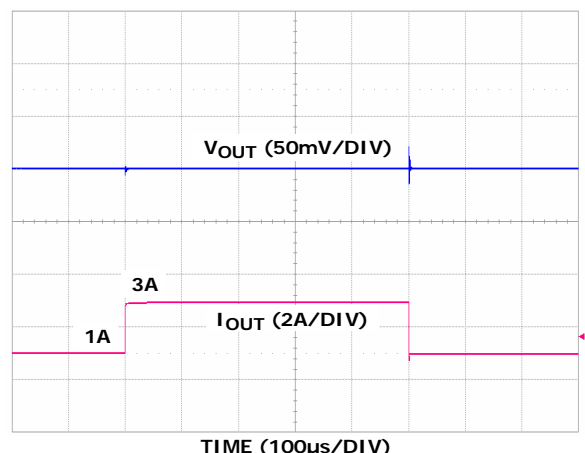

FIGURE 34. LOAD TRANSIENT 1A TO 3A,  $C_{OUT} = 10\mu F$  CERAMIC + 100µF OSCON

## Typical Operating Performance

Unless otherwise noted:  $V_{IN} = 2.2V$ ,  $V_{OUT} = 1.8V$ ,  $C_{IN} = C_{OUT} = 10\mu F$ ,  $T_J = +25^\circ C$ ,  $I_L = 0A$ . (Continued)

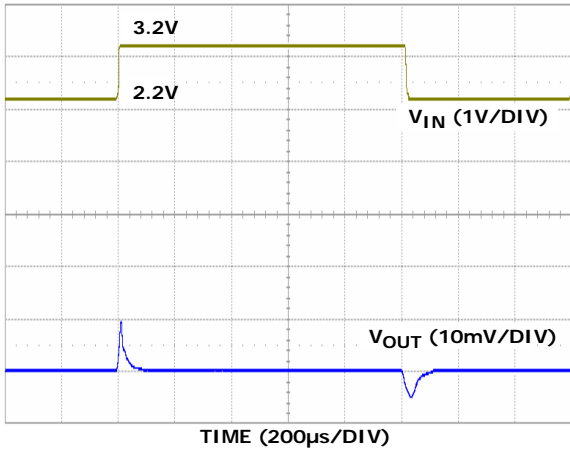

FIGURE 35. LINE TRANSIENT

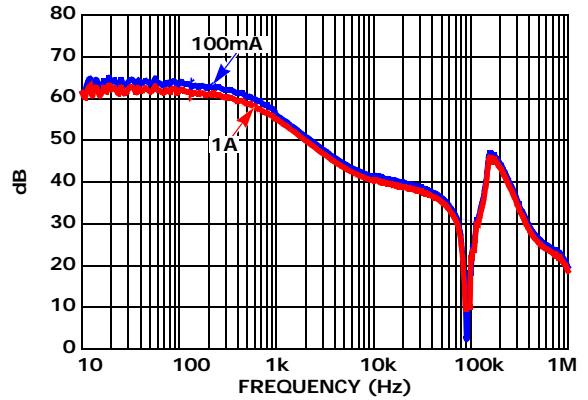

FIGURE 36. PSRR vs LOAD

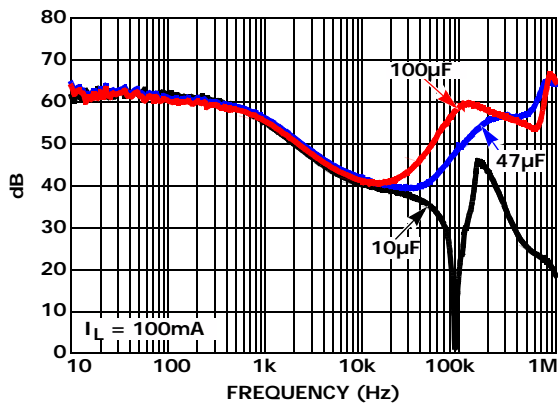

FIGURE 37. PSRR vs  $C_{OUT}$

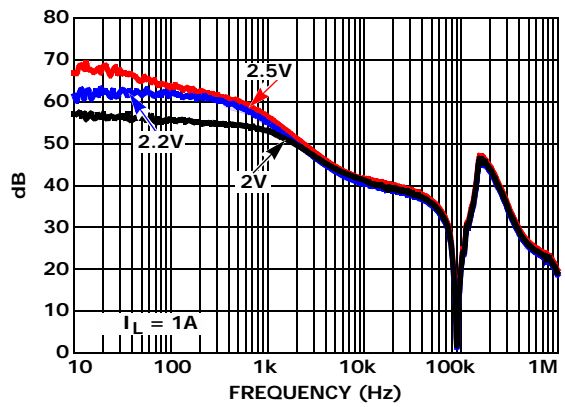

FIGURE 38. PSRR vs  $V_{IN}$

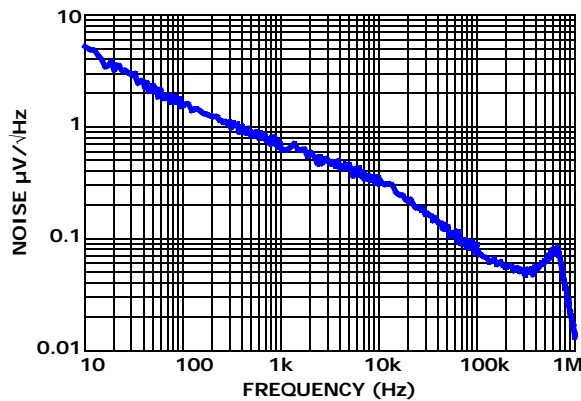

FIGURE 39. SPECTRAL NOISE DENSITY vs FREQUENCY

## Revision History

The revision history provided is for informational purposes only and is believed to be accurate, but not warranted. Please go to web to make sure you have the latest Rev.

DATE	REVISION	CHANGE
09/30/09	FN6660.0	Initial Release.

---

## Products

Intersil Corporation is a leader in the design and manufacture of high-performance analog semiconductors. The Company's products address some of the industry's fastest growing markets, such as, flat panel displays, cell phones, handheld products, and notebooks. Intersil's product families address power management and analog signal processing functions. Go to [www.intersil.com/products](http://www.intersil.com/products) for a complete list of Intersil product families.

\*For a complete listing of Applications, Related Documentation and Related Parts, please see the respective device information page on intersil.com: [ISL80102, ISL80103](http://www.intersil.com/products)

To report errors or suggestions for this datasheet, please go to [www.intersil.com/askourstaff](http://www.intersil.com/askourstaff)

FITs are available from our website at <http://rel.intersil.com/reports/search.php>

For additional products, see [www.intersil.com/product\\_tree](http://www.intersil.com/product_tree)

Intersil products are manufactured, assembled and tested utilizing ISO9000 quality systems as noted in the quality certifications found at [www.intersil.com/design/quality](http://www.intersil.com/design/quality)

*Intersil products are sold by description only. Intersil Corporation reserves the right to make changes in circuit design, software and/or specifications at any time without notice. Accordingly, the reader is cautioned to verify that data sheets are current before placing orders. Information furnished by Intersil is believed to be accurate and reliable. However, no responsibility is assumed by Intersil or its subsidiaries for its use; nor for any infringements of patents or other rights of third parties which may result from its use. No license is granted by implication or otherwise under any patent or patent rights of Intersil or its subsidiaries.*

For information regarding Intersil Corporation and its products, see [www.intersil.com](http://www.intersil.com)

# Package Outline Drawing

## L10.3x3

10 LEAD DUAL FLAT PACKAGE (DFN)

Rev 6, 09/09

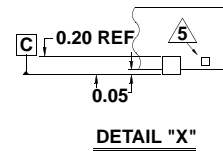
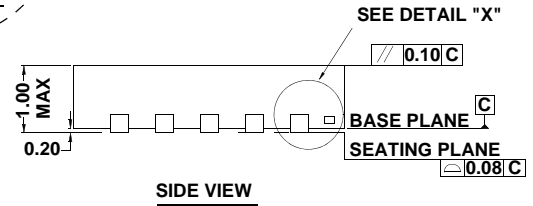
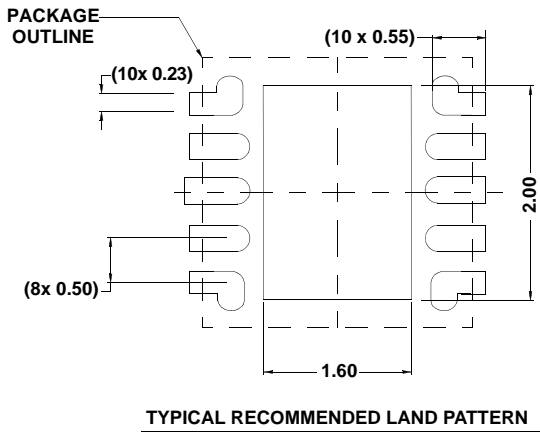
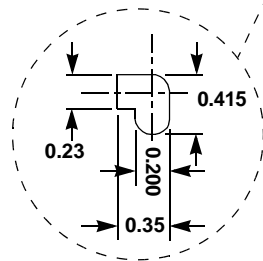
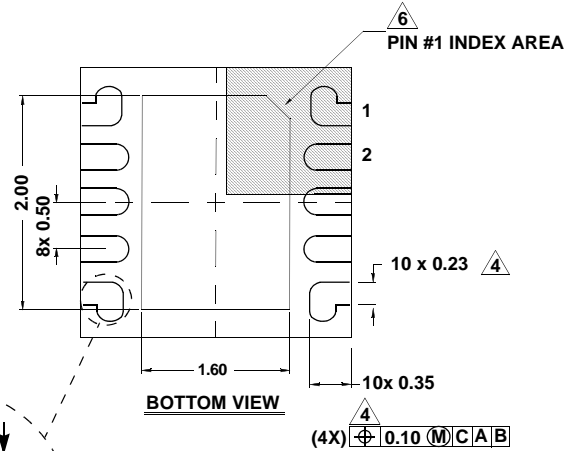
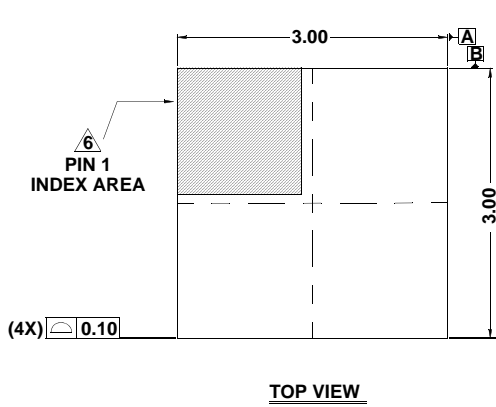

**NOTES:**

1. Dimensions are in millimeters.  
Dimensions in ( ) for Reference Only.
2. Dimensioning and tolerancing conform to AMSE Y14.5m-1994.
3. Unless otherwise specified, tolerance : Decimal  $\pm 0.05$
4. Lead width applies to the metallized terminal and is measured between 0.18mm and 0.30mm from the terminal tip.
5. Tiebar shown (if present) is a non-functional feature.
6. The configuration of the pin #1 identifier is optional, but must be located within the zone indicated. The pin #1 identifier may be either a mold or mark feature.