

# LPV321 SINGLE, LPV358 DUAL, LPV324 QUAD GENERAL-PURPOSE, LOW-VOLTAGE, LOW-POWER, RAIL-TO-RAIL OUTPUT OPERATIONAL AMPLIFIERS

SLOS433H – FEBRUARY 2004 – REVISED OCTOBER 2004

- 2.7-V and 5-V Performance
- $-40^{\circ}\text{C}$  to  $125^{\circ}\text{C}$  Specification at 5 V
- No Crossover Distortion
- Gain Bandwidth of 152 kHz
- Low Supply Current
  - LPV321 . . .  $9\ \mu\text{A}$
  - LPV358 . . .  $15\ \mu\text{A}$
  - LPV324 . . .  $28\ \mu\text{A}$
- Rail-to-Rail Output Swing at 100-k $\Omega$  Load
  - $V_{\text{CC}+}$  – 3.5 mV
  - $V_{\text{CC}-}$  + 90 mV
- $V_{\text{ICR}}$  . . .  $-0.2\ \text{V}$  to  $V_{\text{CC}+} - 0.8\ \text{V}$
- Stable With Capacitive Load of 1000 pF
- Applications
  - Active Filters
  - General-Purpose, Low-Voltage Applications
  - Low-Power and/or Portable Applications
- Latch-Up Performance Exceeds 100 mA per JESD 78, Class II
- ESD Protection Exceeds JESD 22
  - 2000-V Human-Body Model (A114-A)
  - 200-V Machine Model (A115-A)
  - 1000-V Charged-Device Model (C101)

LPV321 . . . DBV OR DCK PACKAGE  
(TOP VIEW)

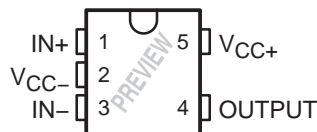

LPV358 . . . D, DDU, OR DGK PACKAGE  
(TOP VIEW)

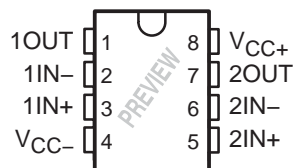

LPV324 . . . D OR PW PACKAGE  
(TOP VIEW)

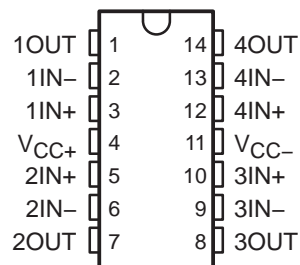

## description/ordering information

The LPV321/358/324 devices are low-power ( $9\ \mu\text{A}$  per channel at 5 V) versions of the LMV321/358/324 operational amplifiers. These are additions to the LMV321/358/324 family of commodity operational amplifiers.

The LPV321/358/324 devices are the most cost-effective solutions for applications where low voltage, low-power operation, space saving, and low price are needed. These devices have rail-to-rail output-swing capability, and the input common-mode voltage range includes ground. They all exhibit excellent speed-power ratios, achieving 152 kHz of bandwidth, with a supply current of only  $9\ \mu\text{A}$  typical.

The LPV321, LPV358, and LPV324 are characterized for operation from  $-40^{\circ}\text{C}$  to  $85^{\circ}\text{C}$ . The LPV321I, LPV358I, and LPV324I are characterized for operation from  $-40^{\circ}\text{C}$  to  $125^{\circ}\text{C}$ .



Please be aware that an important notice concerning availability, standard warranty, and use in critical applications of Texas Instruments semiconductor products and disclaimers thereto appears at the end of this data sheet.

PRODUCTION DATA information is current as of publication date. Products conform to specifications per the terms of Texas Instruments standard warranty. Production processing does not necessarily include testing of all parameters.

 **TEXAS  
INSTRUMENTS**

POST OFFICE BOX 655303 • DALLAS, TEXAS 75265

Copyright © 2004, Texas Instruments Incorporated

**LPV321 SINGLE, LPV358 DUAL, LPV324 QUAD**  
**GENERAL-PURPOSE, LOW-VOLTAGE, LOW-POWER, RAIL-TO-RAIL OUTPUT**  
**OPERATIONAL AMPLIFIERS**

SLOS433H – FEBRUARY 2004 – REVISED OCTOBER 2004

**description/ordering information (continued)**

**ORDERING INFORMATION**

T <sub>A</sub>	PACKAGE†		ORDERABLE PART NUMBER	TOP-SIDE MARKING	
-40°C to 85°C	Single	SOT23-5 (DBV)	Reel of 3000	LPV321DBVR	PREVIEW
			Reel of 250	LPV321DBVT	
		SOT23-5 (DCK)	Reel of 3000	LPV321DCKR	PREVIEW
			Reel of 250	LPV321DCKT	
	Dual	SOIC-8 (D)	Tube of 75	LPV358D	PREVIEW
			Reel of 2500	LPV358DR	
		VSSOP-8 (DDU)	Reel of 3000	LPV358DDUR	PREVIEW
			Reel of 2500	LPV358DGKR	
	VSSOP-8 (DGK)	Reel of 250	LPV358DGKT	PREVIEW	
		Reel of 250	LPV358DGKT		
Quad	SOIC-14 (D)	Tube of 50	LPV324D	LPV324	
		Reel of 2500	LPV324DR		
	TSSOP-14 (PW)	Tube of 90	LPV324PW	PV324	
		Reel of 2000	LPV324PWR		
-40°C to 125°C	Single	SOT23-5 (DBV)	Reel of 3000	LPV321IDBVR	PREVIEW
			Reel of 250	LPV321IDBVT	
		SOT23-5 (DCK)	Reel of 3000	LPV321IDCKR	PREVIEW
			Reel of 250	LPV321IDCKT	
	Dual	SOIC-8 (D)	Tube of 75	LPV358ID	PREVIEW
			Reel of 2500	LPV358IDR	
		VSSOP-8 (DDU)	Reel of 3000	LPV358IDDUR	PREVIEW
			Reel of 2500	LPV358IDGKR	
	VSSOP-8 (DGK)	Reel of 250	LPV358IDGKT	PREVIEW	
		Reel of 250	LPV358IDGKT		
Quad	SOIC-14 (D)	Tube of 50	LPV324ID	LPV324I	
		Reel of 2500	LPV324IDR		
	TSSOP-14 (PW)	Tube of 90	LPV324IPW	PV324I	
		Reel of 2000	LPV324IPWR		

† Package drawings, standard packing quantities, thermal data, symbolization, and PCB design guidelines are available at [www.ti.com/sc/package](http://www.ti.com/sc/package).

**symbol (each amplifier)**

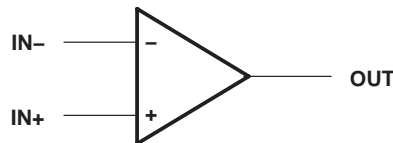

# LPV321 SINGLE, LPV358 DUAL, LPV324 QUAD GENERAL-PURPOSE, LOW-VOLTAGE, LOW-POWER, RAIL-TO-RAIL OUTPUT OPERATIONAL AMPLIFIERS

SLOS433H – FEBRUARY 2004 – REVISED OCTOBER 2004

## LPV324 simplified schematic

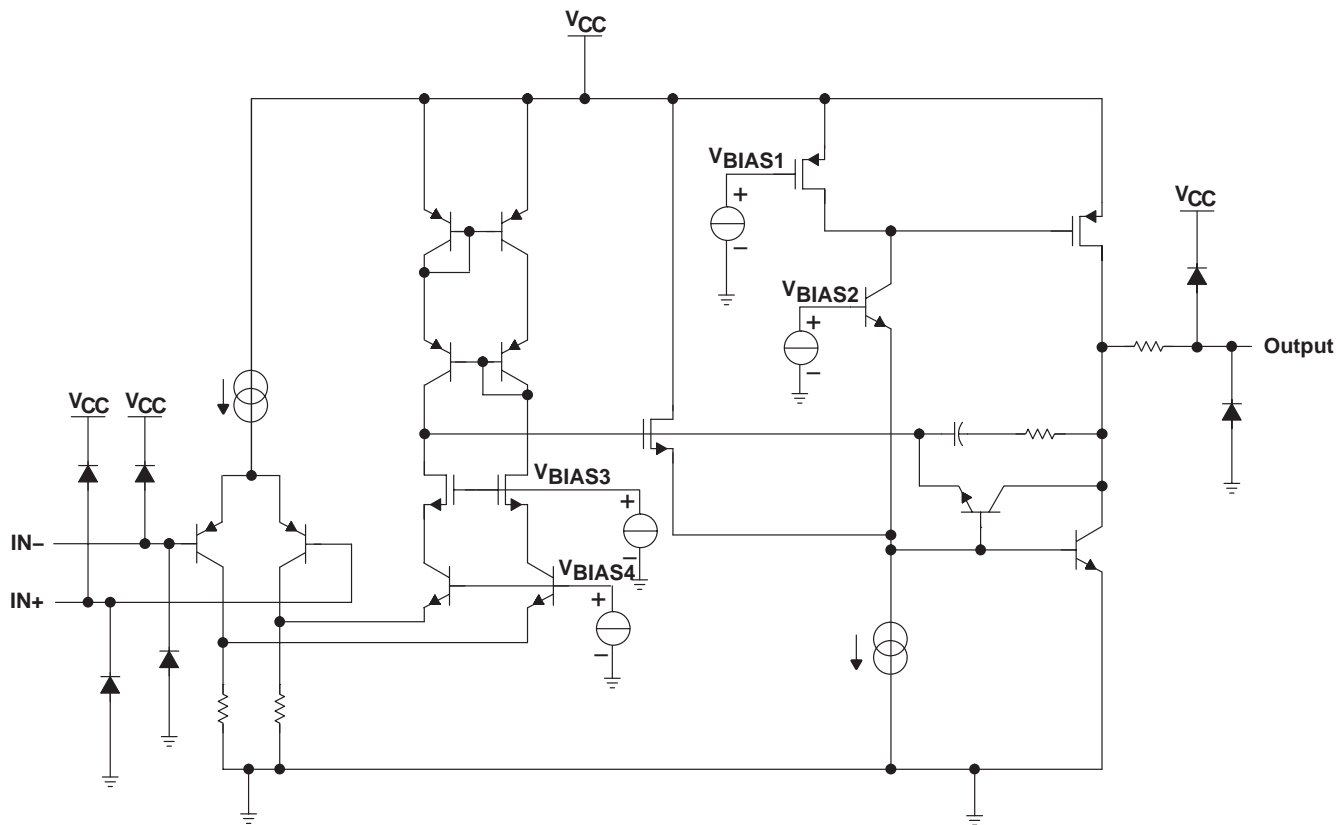

### absolute maximum ratings over operating free-air temperature range (unless otherwise noted)†

Supply voltage, $V_{CC+} - V_{CC-}$ (see Note 1)	5.5 V
Differential input voltage, $V_{ID}$ (see Note 2)	$\pm V_{CC}$
Input voltage range, $V_I$ (either input)	$V_{CC-}$ to $V_{CC+} - 1$ V
Package thermal impedance, $\theta_{JA}$ (see Notes 3 and 4):	
5-pin DBV package	206°C/W
5-pin DCK package	252°C/W
8-pin D package	97°C/W
8-pin DDU package	TBD°C/W
8-pin DGK package	172°C/W
14-pin D package	86°C/W
14-pin PW package	113°C/W
Maximum junction temperature, $T_J$	150°C
Storage temperature range, $T_{Stg}$	-65°C to 150°C

† Stresses beyond those listed under “absolute maximum ratings” may cause permanent damage to the device. These are stress ratings only, and functional operation of the device at these or any other conditions beyond those indicated under “recommended operating conditions” is not implied. Exposure to absolute-maximum-rated conditions for extended periods may affect device reliability.

- NOTES:
1. All voltage values, except differential voltages and  $V_{CC}$  specified for the measurement of  $I_{OS}$ , are with respect to the network GND.
  2. Differential voltages are at IN+ with respect to IN-.
  3. Maximum power dissipation is a function of  $T_J(\max)$ ,  $\theta_{JA}$ , and  $T_A$ . The maximum allowable power dissipation at any allowable ambient temperature is  $P_D = (T_J(\max) - T_A)/\theta_{JA}$ . Selecting the maximum of 150°C can affect reliability.
  4. The package thermal impedance is calculated in accordance with JESD 51-7.

**LPV321 SINGLE, LPV358 DUAL, LPV324 QUAD  
GENERAL-PURPOSE, LOW-VOLTAGE, LOW-POWER, RAIL-TO-RAIL OUTPUT  
OPERATIONAL AMPLIFIERS**

SLOS433H – FEBRUARY 2004 – REVISED OCTOBER 2004

**recommended operating conditions**

		MIN	MAX	UNIT	
V <sub>CC</sub>	Supply voltage	2.7	5	V	
T <sub>A</sub>	Operating free-air temperature	LPV3xx	-40	85	°C
		LPV3xxI	-40	125	

**ESD protection**

TEST CONDITIONS	TYP	UNIT
Human-Body Model	2	kV
Machine model	200	V
Charged-Device Model	1	kV



**LPV321 SINGLE, LPV358 DUAL, LPV324 QUAD  
GENERAL-PURPOSE, LOW-VOLTAGE, LOW-POWER, RAIL-TO-RAIL OUTPUT  
OPERATIONAL AMPLIFIERS**

SLOS433H – FEBRUARY 2004 – REVISED OCTOBER 2004

**2.7-V electrical characteristics**

$T_A = 25^\circ\text{C}$ ,  $V_{CC+} = 2.7\text{ V}$ ,  $V_{CC-} = 0\text{ V}$ ,  $V_{IC} = 1\text{ V}$ ,  $V_O = V_{CC+}/2$ , and  $R_L > 1\text{ M}\Omega$  (unless otherwise noted)

PARAMETER		TEST CONDITIONS		MIN	TYP†	MAX	UNIT
$V_{IO}$	Input offset voltage				1.2	7	mV
$\alpha_{VIO}$	Average temperature coefficient of input offset voltage				4		$\mu\text{V}/^\circ\text{C}$
$I_{IB}$	Input bias current				1.7	50	nA
$I_{IO}$	Input offset current				0.6	40	nA
CMRR	Common-mode rejection ratio	$0 \leq V_{IC} \leq 1.7\text{ V}$		50	70		dB
$k_{SVR}$	Supply-voltage rejection ratio	$2.7\text{ V} \leq V_{CC+} \leq 5\text{ V}$ , $V_{IC} = 1\text{ V}$ , $V_O = 1\text{ V}$		50	65		dB
$V_{ICR}$	Common-mode input voltage range	CMRR $\geq 50\text{ dB}$		0 to 1.7	-0.2 to 1.9		V
$V_O$	Output swing	$R_L = 100\text{ k}\Omega$ to $1.35\text{ V}$	High level	$V_{CC+} - 0.100$	$V_{CC+} - 0.003$		V
			Low level		0.080	0.180	
$I_{CC}$	Supply current	LPV321§			4	8	$\mu\text{A}$
		LPV358 (both amplifiers)§			8	16	
		LPV324 (all four amplifiers)			16	24	
SR	Slew rate‡				0.1		V/ $\mu\text{s}$
GBW	Gain bandwidth product	$C_L = 22\text{ pF}$ (see Note 5)			205		kHz
$\Phi_m$	Phase margin	$C_L = 22\text{ pF}$ (see Note 5)			71		deg
	Gain margin	$C_L = 22\text{ pF}$ (see Note 5)			11		dB
$V_n$	Equivalent input noise voltage	$f = 1\text{ kHz}$			178		$\text{nV}/\sqrt{\text{Hz}}$
$I_n$	Equivalent input noise current	$f = 1\text{ kHz}$			0.5		$\text{pA}/\sqrt{\text{Hz}}$

† All typical values are at  $V_{CC} = 2.7\text{ V}$ ,  $T_A = 25^\circ\text{C}$ .

‡ Number specified is the slower of the positive and negative slew rates.

§ Product Preview

NOTE 5: Closed-loop gain = 18 dB,  $V_{IC} = V_{CC+}/2$



# LPV321 SINGLE, LPV358 DUAL, LPV324 QUAD GENERAL-PURPOSE, LOW-VOLTAGE, LOW-POWER, RAIL-TO-RAIL OUTPUT OPERATIONAL AMPLIFIERS

SLOS433H – FEBRUARY 2004 – REVISED OCTOBER 2004

## 5-V electrical characteristics

$T_A = 25^\circ\text{C}$ ,  $V_{CC+} = 5\text{ V}$ ,  $V_{CC-} = 0\text{ V}$ ,  $V_{IC} = 2\text{ V}$ ,  $V_O = V_{CC+}/2$ , and  $R_L > 1\text{ M}\Omega$  (unless otherwise noted)

PARAMETER	TEST CONDITIONS	$T_A$	MIN	TYP†	MAX	UNIT	
$V_{IO}$ Input offset voltage		25°C		1.5	7	mV	
		-40°C to 85°C			10		
		-40°C to 125°C			11		
$\alpha_{VIO}$ Average temperature coefficient of input offset voltage		25°C		4		$\mu\text{V}/^\circ\text{C}$	
$I_{IB}$ Input bias current		25°C		2	50	nA	
		-40°C to 85°C			60		
		-40°C to 125°C			65		
CMRR Common-mode rejection ratio	$0 \leq V_{IC} \leq 4\text{ V}$	25°C	50	71		dB	
$k_{SVR}$ Supply-voltage rejection ratio	$2.7\text{ V} \leq V_{CC+} \leq 5\text{ V}$ , $V_{IC} = 1\text{ V}$ , $V_O = 1\text{ V}$	25°C	50	65		dB	
$V_{ICR}$ Common-mode input voltage range	CMRR $\geq 50\text{ dB}$	25°C	0 to 4	-0.2 to 4.2		V	
$I_{IO}$ Input offset current		25°C		0.6	40	nA	
		-40°C to 85°C			50		
		-40°C to 125°C			55		
$V_O$ Output swing	$R_L = 100\text{ k}\Omega$ to $2.5\text{ V}$	High level	25°C	$V_{CC+} - 0.100$	$V_{CC+} - 0.0035$	V	
			-40°C to 85°C	$V_{CC+} - 0.200$			
			-40°C to 125°C	$V_{CC+} - 0.225$			
		Low level	25°C		0.090		0.180
			-40°C to 85°C				0.220
			-40°C to 125°C				0.240
$I_{OS}$ Output short-circuit current	Sourcing, $V_O = 0\text{ V}$	25°C	2	17	mA		
	Sinking, $V_O = 5\text{ V}$		20	72			
$I_{CC}$ Supply current	LPV321‡	25°C		9	12	$\mu\text{A}$	
		-40°C to 85°C			15		
		-40°C to 125°C			40		
	LPV358 (both amplifiers)‡	25°C		15	20		
		-40°C to 85°C			24		
		-40°C to 125°C			80		
	LPV324 (all four amplifiers)	25°C		28	42		
		-40°C to 85°C			46		
		-40°C to 125°C			125		
$A_{VS}$ Large-signal voltage gain	$R_L = 100\text{ k}\Omega$	25°C	15	100	V/mV		
		-40°C to 85°C	10				
		-40°C to 125°C	10				
$SR$ ¶ Slew rate		25°C		0.1		V/ $\mu\text{s}$	

† All typical values are at  $V_{CC} = 5\text{ V}$ ,  $T_A = 25^\circ\text{C}$ .

‡ Product Preview

§  $R_L$  is connected to  $V_{CC-}$ . The output voltage is  $0.5\text{ V} \leq V_O \leq 4.5\text{ V}$ .

¶ Number specified is the slower of the positive and negative slew rates. Connected as a voltage follower with 3-V step input.



**LPV321 SINGLE, LPV358 DUAL, LPV324 QUAD  
GENERAL-PURPOSE, LOW-VOLTAGE, LOW-POWER, RAIL-TO-RAIL OUTPUT  
OPERATIONAL AMPLIFIERS**

SLOS433H – FEBRUARY 2004 – REVISED OCTOBER 2004

**5-V electrical characteristics**

**$T_A = 25^\circ\text{C}$ ,  $V_{CC+} = 5\text{ V}$ ,  $V_{CC-} = 0\text{ V}$ ,  $V_{IC} = 2\text{ V}$ ,  $V_O = V_{CC+}/2$ , and  $R_L > 1\text{ M}\Omega$  (unless otherwise noted)  
(continued)**

PARAMETER		TEST CONDITIONS	$T_A$	MIN	TYP†	MAX	UNIT
GBW	Gain bandwidth product	$C_L = 22\text{ pF}$ (see Note 5)	$25^\circ\text{C}$		237		kHz
$\Phi_m$	Phase margin	$C_L = 22\text{ pF}$ (see Note 5)	$25^\circ\text{C}$		74		deg
	Gain margin	$C_L = 22\text{ pF}$ (see Note 5)	$25^\circ\text{C}$		12		dB
$V_n$	Equivalent input noise voltage	$f = 1\text{ kHz}$	$25^\circ\text{C}$		146		$\text{nV}/\sqrt{\text{Hz}}$
$I_n$	Equivalent input noise current	$f = 1\text{ kHz}$	$25^\circ\text{C}$		0.3		$\text{pA}/\sqrt{\text{Hz}}$

† All typical values are at  $V_{CC} = 5\text{ V}$ ,  $T_A = 25^\circ\text{C}$ .

NOTE 5: Closed-loop gain = 18 dB,  $V_{IC} = V_{CC+}/2$

# LPV321 SINGLE, LPV358 DUAL, LPV324 QUAD GENERAL-PURPOSE, LOW-VOLTAGE, LOW-POWER, RAIL-TO-RAIL OUTPUT OPERATIONAL AMPLIFIERS

SLOS433H – FEBRUARY 2004 – REVISED OCTOBER 2004

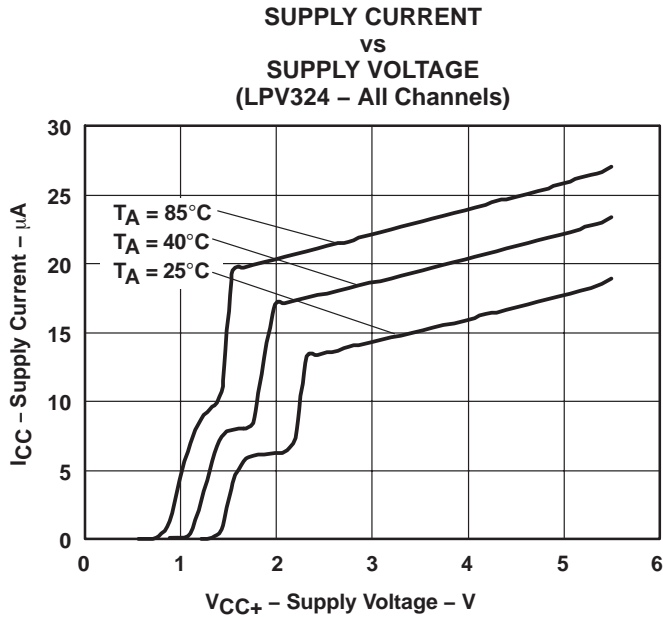

Figure 1

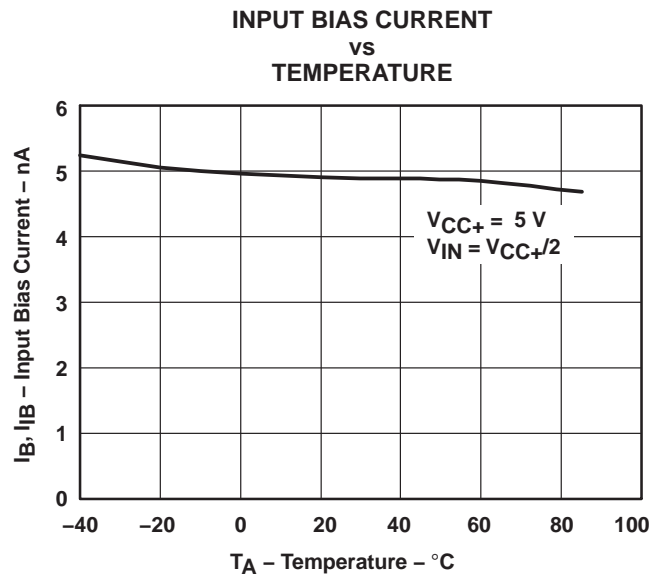

Figure 2

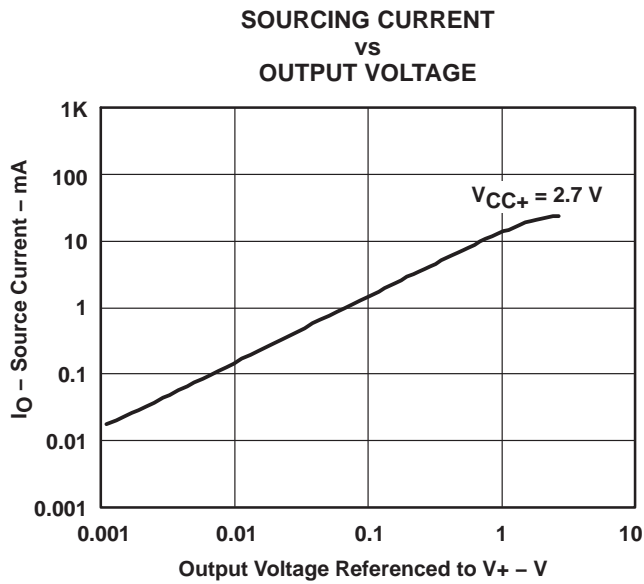

Figure 3

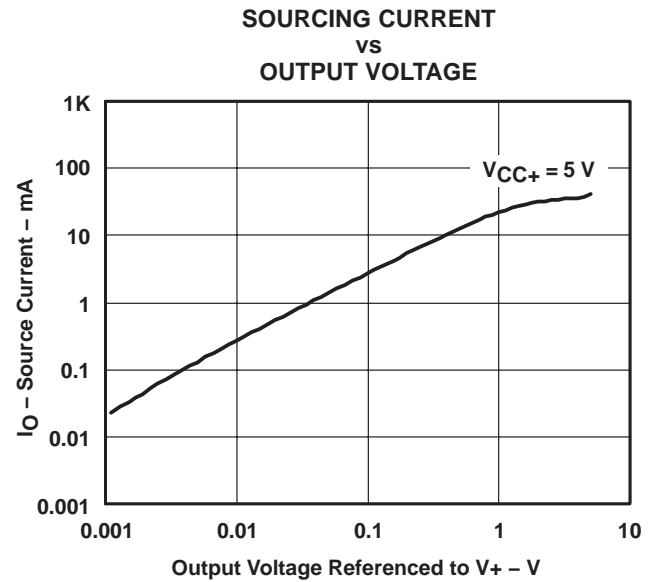

Figure 4



**LPV321 SINGLE, LPV358 DUAL, LPV324 QUAD  
GENERAL-PURPOSE, LOW-VOLTAGE, LOW-POWER, RAIL-TO-RAIL OUTPUT  
OPERATIONAL AMPLIFIERS**

SLOS433H – FEBRUARY 2004 – REVISED OCTOBER 2004

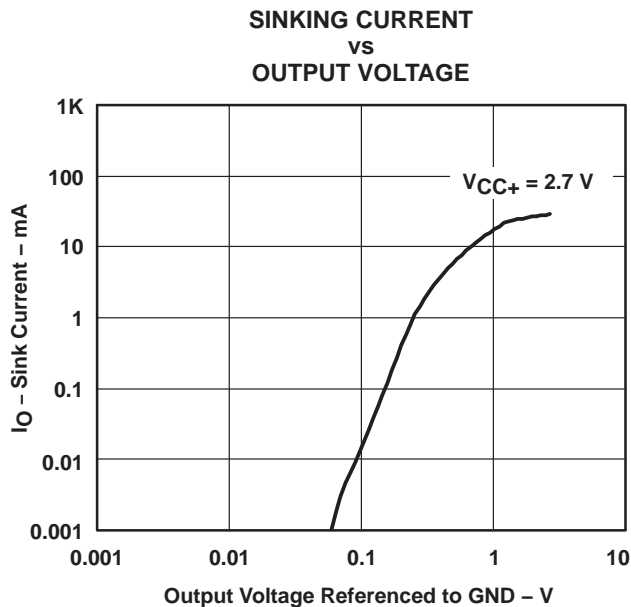

Figure 5

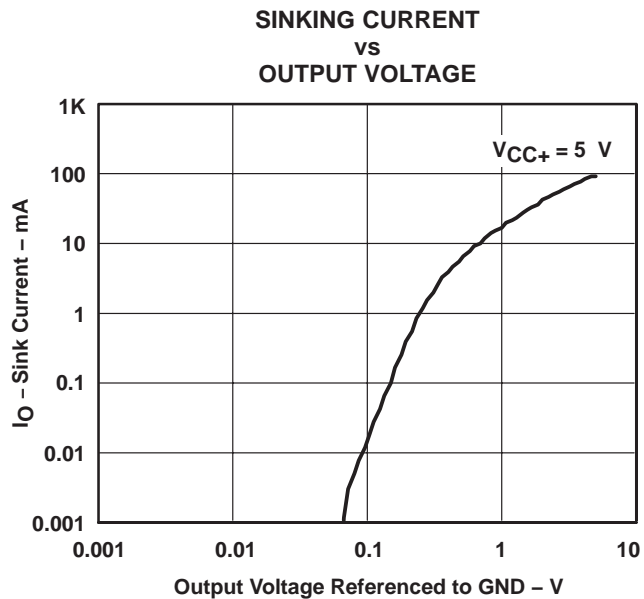

Figure 6

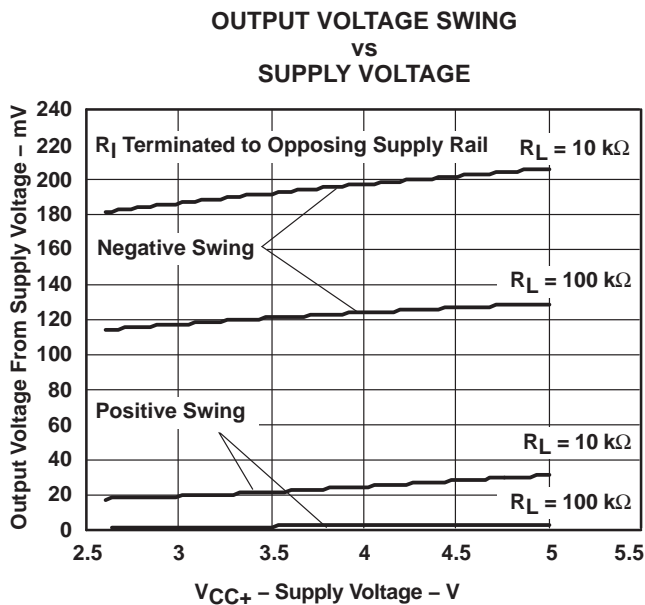

Figure 7

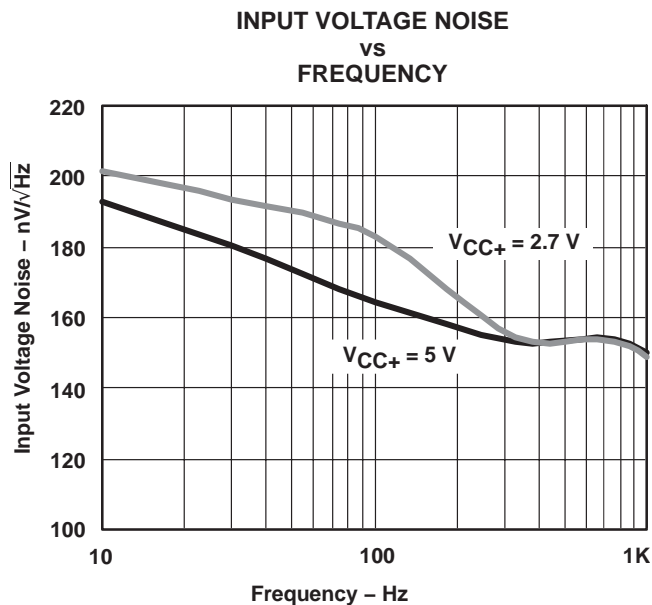

Figure 8

**LPV321 SINGLE, LPV358 DUAL, LPV324 QUAD  
GENERAL-PURPOSE, LOW-VOLTAGE, LOW-POWER, RAIL-TO-RAIL OUTPUT  
OPERATIONAL AMPLIFIERS**

SLOS433H – FEBRUARY 2004 – REVISED OCTOBER 2004

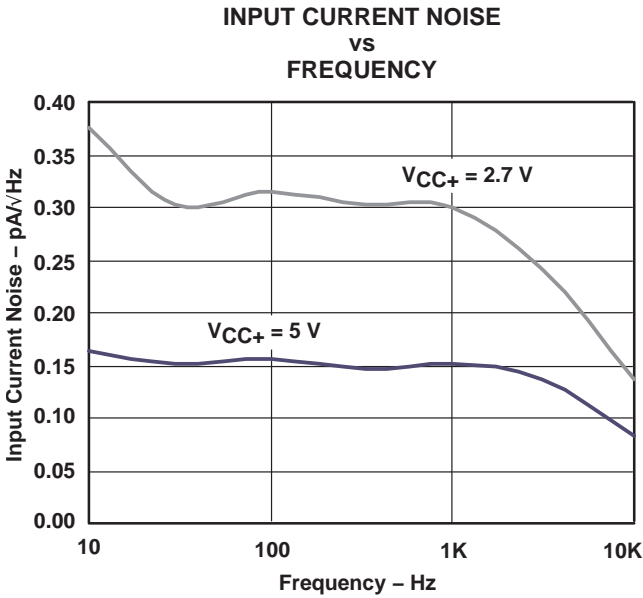

Figure 9

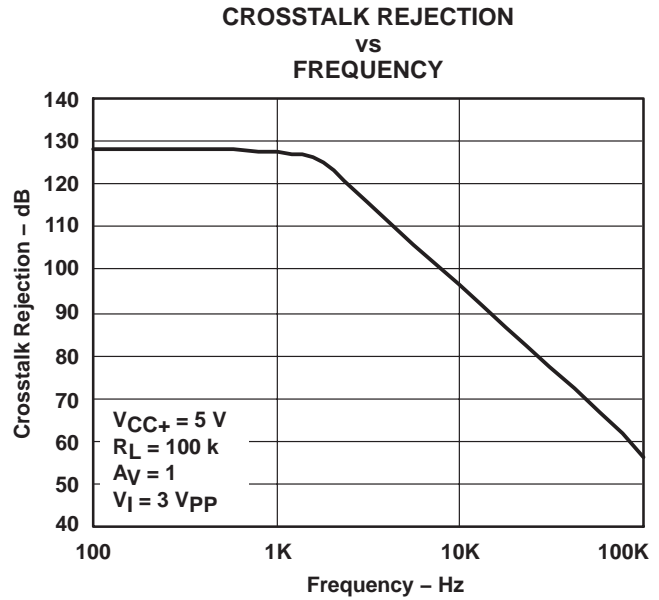

Figure 10

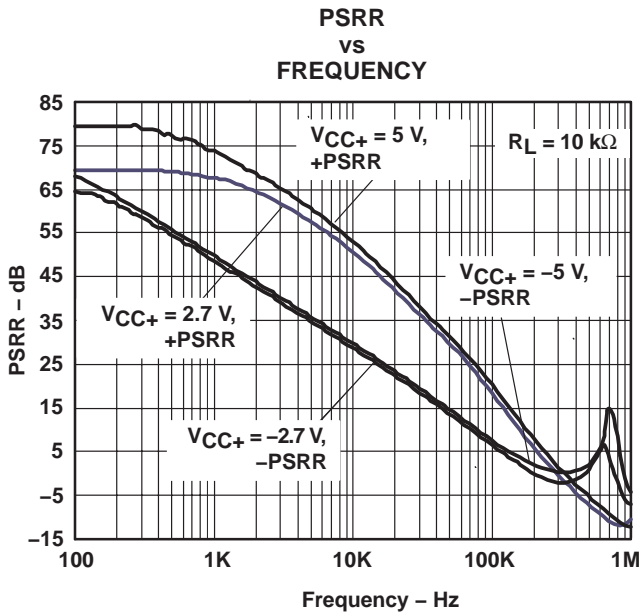

Figure 11

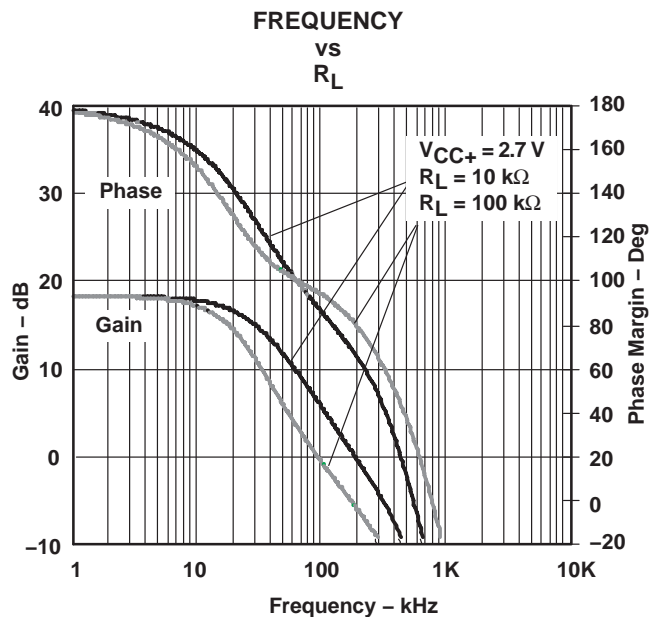

Figure 12



# LPV321 SINGLE, LPV358 DUAL, LPV324 QUAD GENERAL-PURPOSE, LOW-VOLTAGE, LOW-POWER, RAIL-TO-RAIL OUTPUT OPERATIONAL AMPLIFIERS

SLOS433H – FEBRUARY 2004 – REVISED OCTOBER 2004

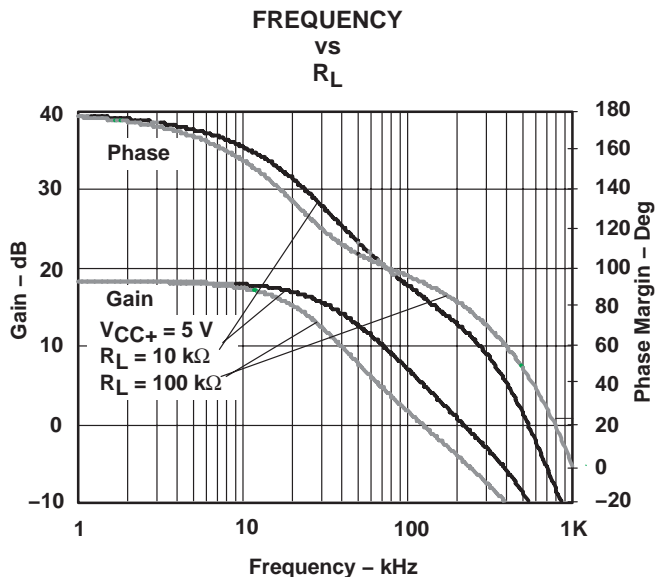

Figure 13

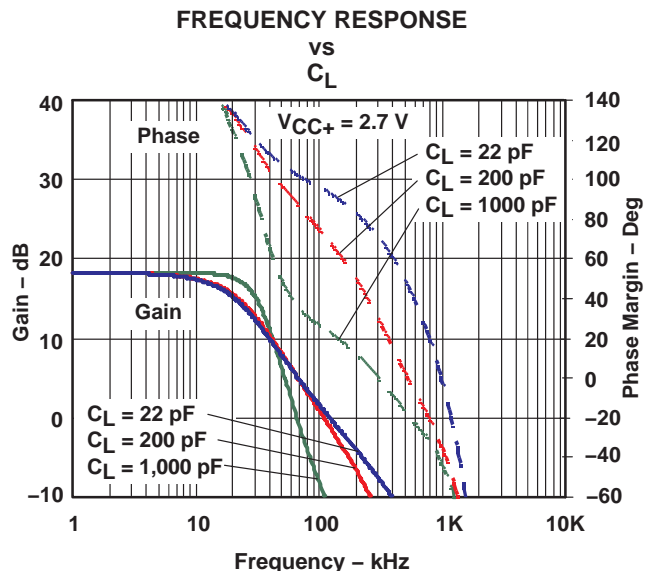

Figure 14

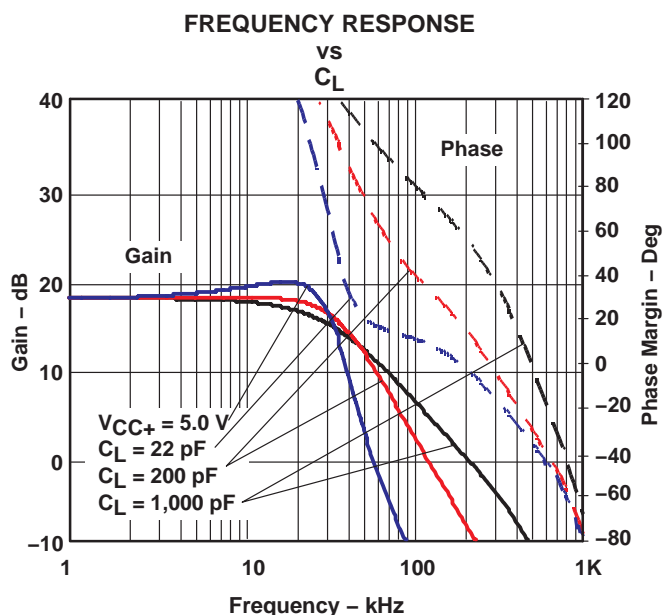

Figure 15

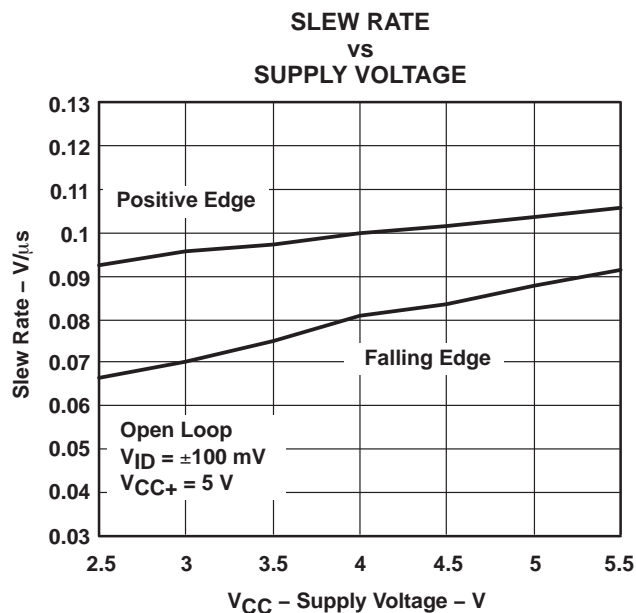

Figure 16

# LPV321 SINGLE, LPV358 DUAL, LPV324 QUAD GENERAL-PURPOSE, LOW-VOLTAGE, LOW-POWER, RAIL-TO-RAIL OUTPUT OPERATIONAL AMPLIFIERS

SLOS433H – FEBRUARY 2004 – REVISED OCTOBER 2004

NONINVERTING LARGE-SIGNAL PULSE RESPONSE

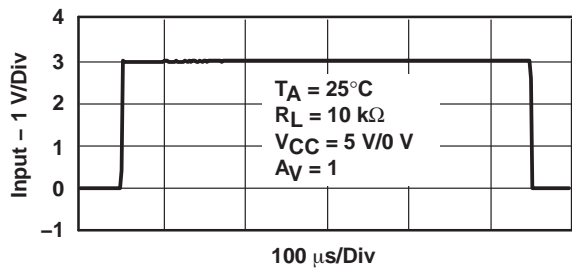

Figure 17

NONINVERTING SMALL-SIGNAL PULSE RESPONSE

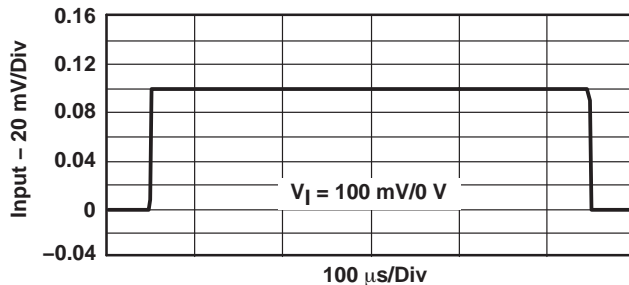

Figure 18

INVERTING LARGE-SIGNAL PULSE RESPONSE

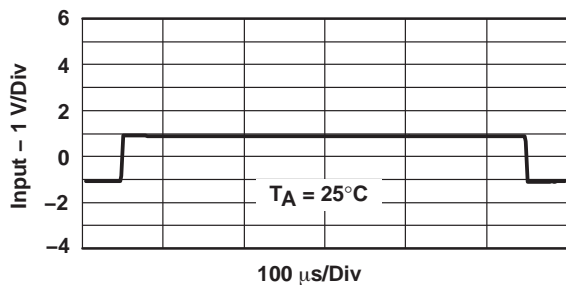

Figure 19

INVERTING SMALL-SIGNAL PULSE RESPONSE

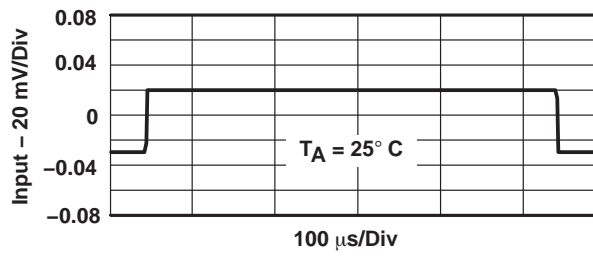
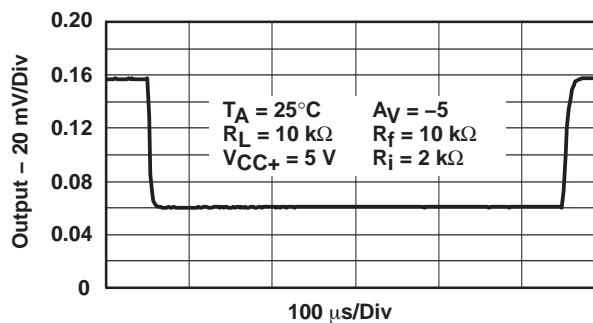
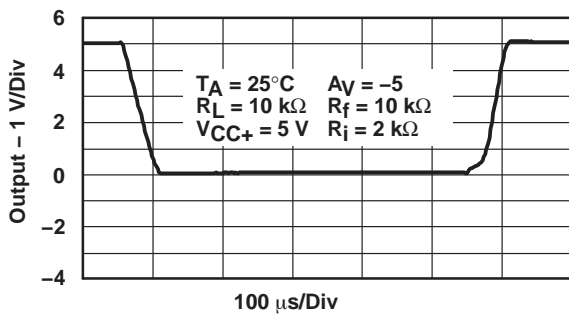
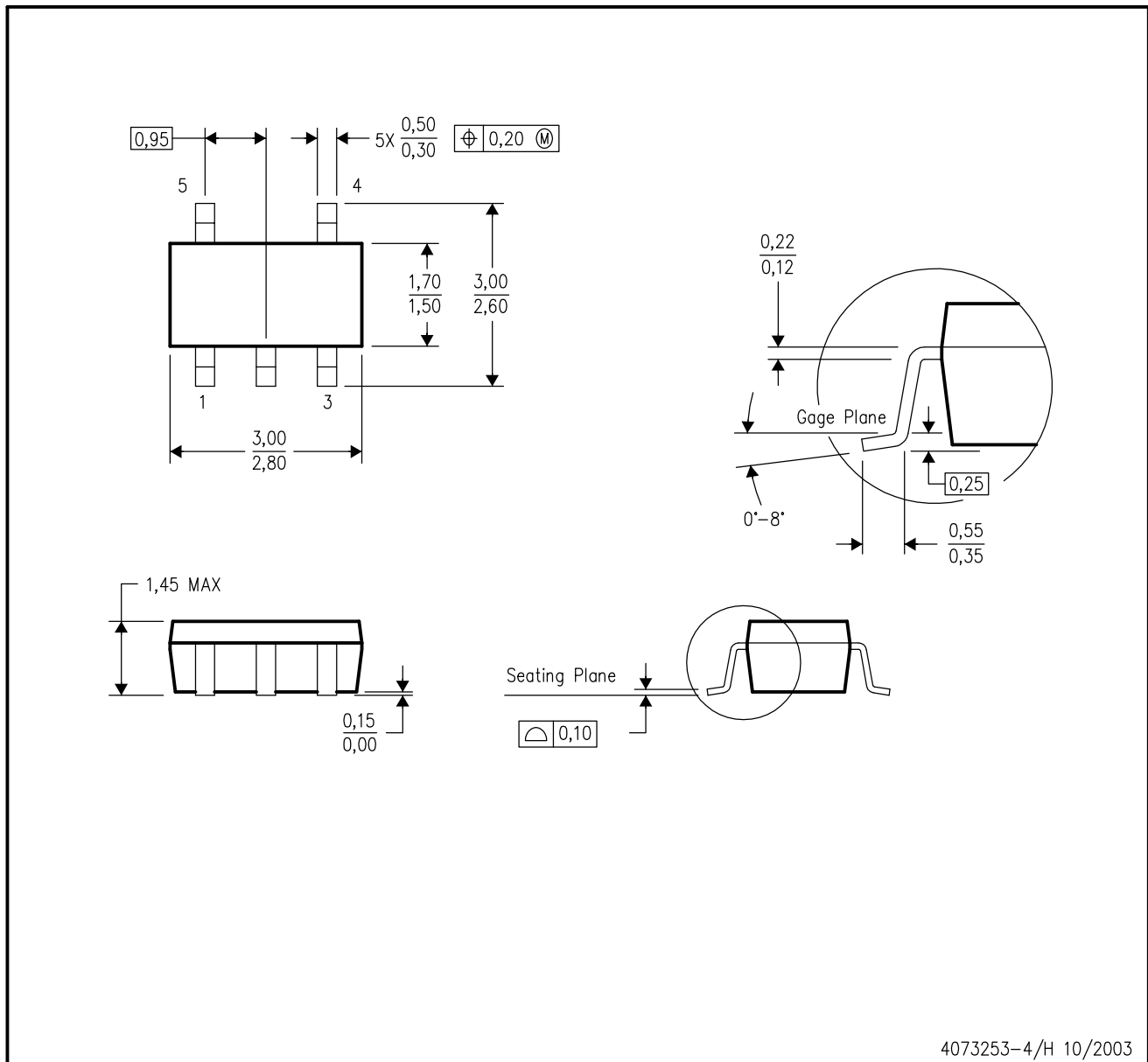

Figure 20



DBV (R-PDSO-G5)

PLASTIC SMALL-OUTLINE PACKAGE



- NOTES:
- A. All linear dimensions are in millimeters.
  - B. This drawing is subject to change without notice.
  - C. Body dimensions do not include mold flash or protrusion.
  - D. Falls within JEDEC MO-178 Variation AA.

D (R-PDSO-G14)

PLASTIC SMALL-OUTLINE PACKAGE



- NOTES:
- A. All linear dimensions are in inches (millimeters).
  - B. This drawing is subject to change without notice.
  - C. Body dimensions do not include mold flash or protrusion not to exceed 0.006 (0,15).
  - D. Falls within JEDEC MS-012 variation AB.

D (R-PDSO-G8)

PLASTIC SMALL-OUTLINE PACKAGE

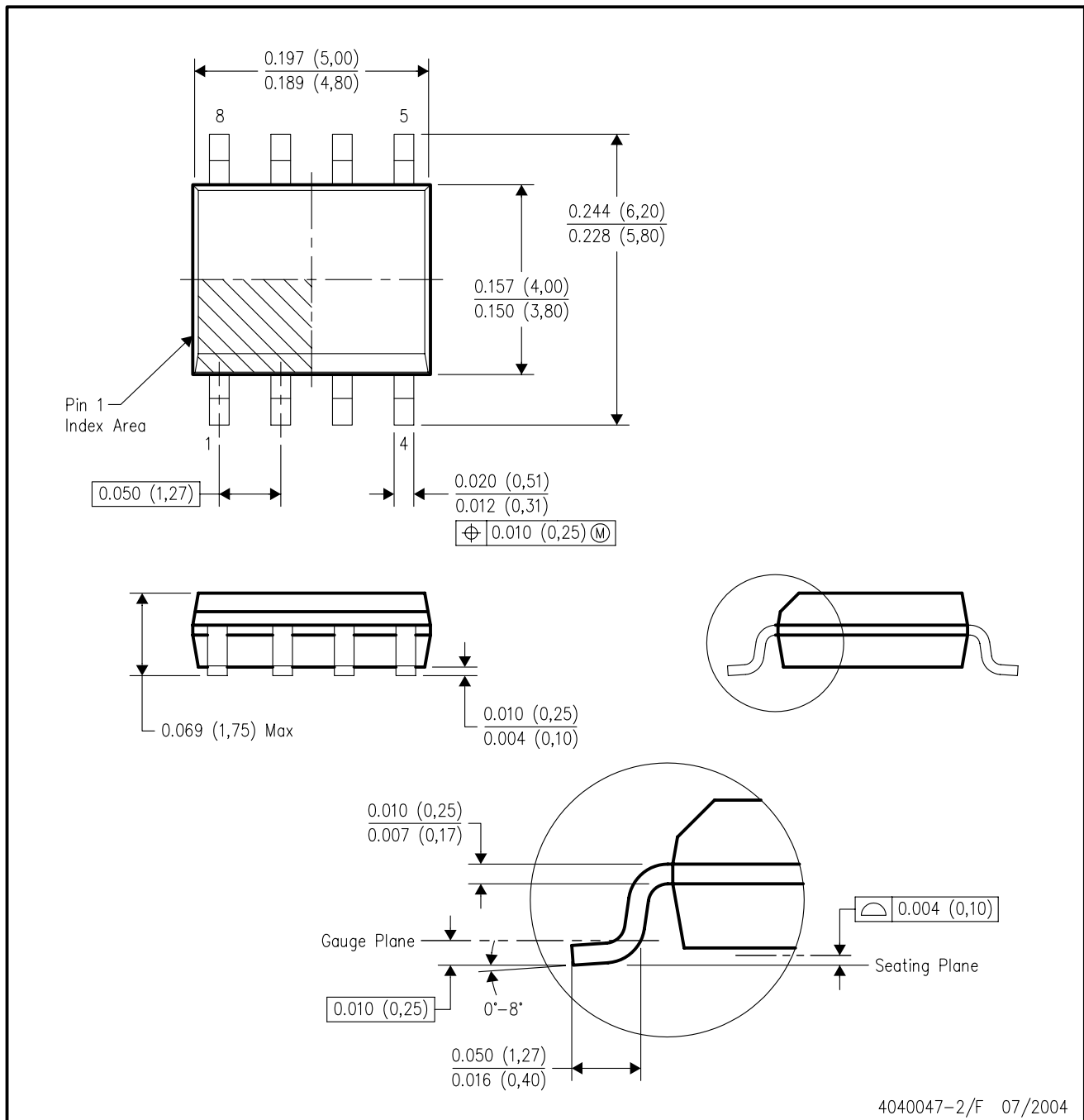

- NOTES:
- A. All linear dimensions are in inches (millimeters).
  - B. This drawing is subject to change without notice.
  - C. Body dimensions do not include mold flash or protrusion not to exceed 0.006 (0,15).
  - D. Falls within JEDEC MS-012 variation AA.

PW (R-PDSO-G\*\*)

PLASTIC SMALL-OUTLINE PACKAGE

14 PINS SHOWN

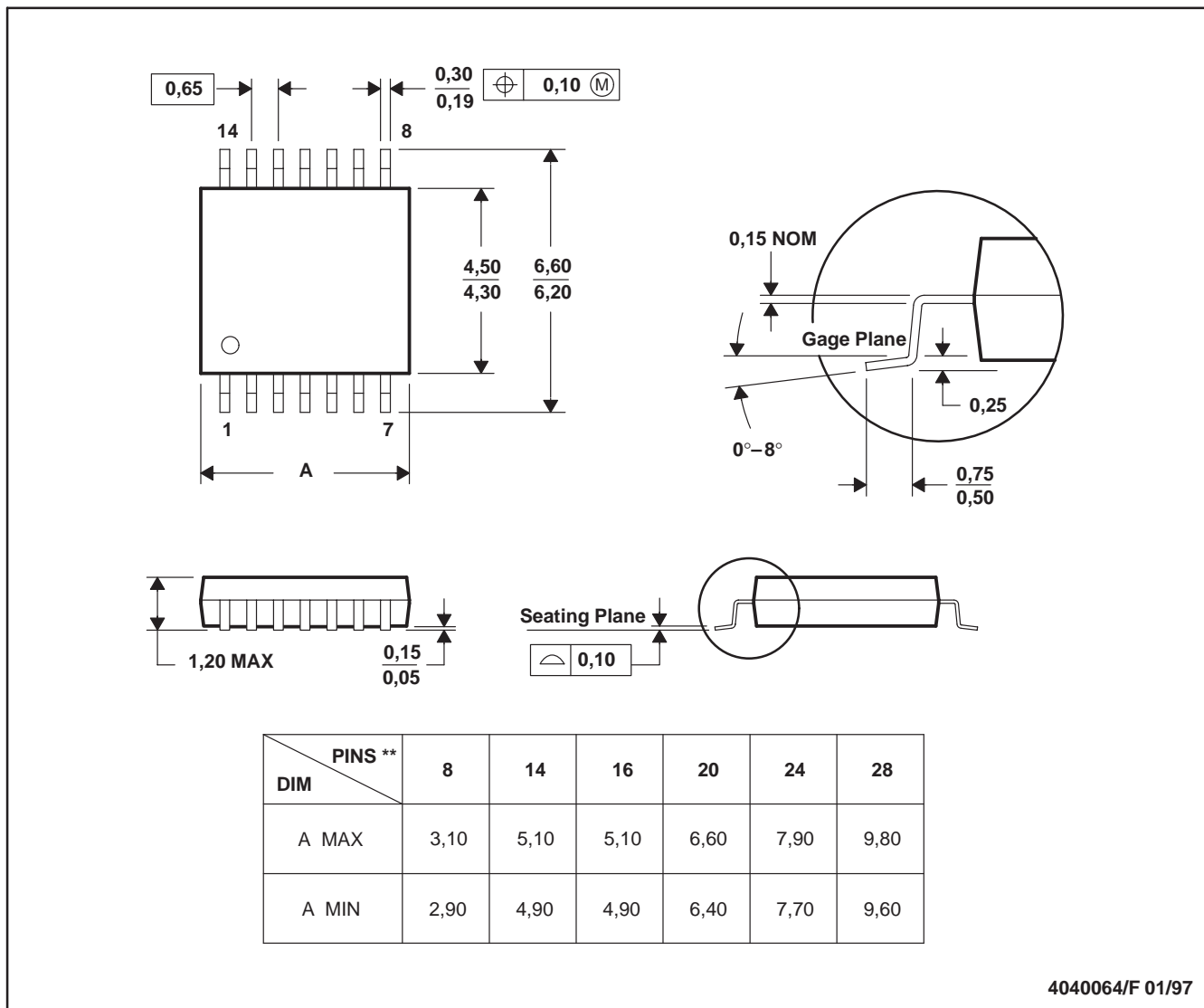

4040064/F 01/97

- NOTES: A. All linear dimensions are in millimeters.  
 B. This drawing is subject to change without notice.  
 C. Body dimensions do not include mold flash or protrusion not to exceed 0,15.  
 D. Falls within JEDEC MO-153



## IMPORTANT NOTICE

Texas Instruments Incorporated and its subsidiaries (TI) reserve the right to make corrections, modifications, enhancements, improvements, and other changes to its products and services at any time and to discontinue any product or service without notice. Customers should obtain the latest relevant information before placing orders and should verify that such information is current and complete. All products are sold subject to TI's terms and conditions of sale supplied at the time of order acknowledgment.

TI warrants performance of its hardware products to the specifications applicable at the time of sale in accordance with TI's standard warranty. Testing and other quality control techniques are used to the extent TI deems necessary to support this warranty. Except where mandated by government requirements, testing of all parameters of each product is not necessarily performed.

TI assumes no liability for applications assistance or customer product design. Customers are responsible for their products and applications using TI components. To minimize the risks associated with customer products and applications, customers should provide adequate design and operating safeguards.

TI does not warrant or represent that any license, either express or implied, is granted under any TI patent right, copyright, mask work right, or other TI intellectual property right relating to any combination, machine, or process in which TI products or services are used. Information published by TI regarding third-party products or services does not constitute a license from TI to use such products or services or a warranty or endorsement thereof. Use of such information may require a license from a third party under the patents or other intellectual property of the third party, or a license from TI under the patents or other intellectual property of TI.

Reproduction of information in TI data books or data sheets is permissible only if reproduction is without alteration and is accompanied by all associated warranties, conditions, limitations, and notices. Reproduction of this information with alteration is an unfair and deceptive business practice. TI is not responsible or liable for such altered documentation.

Resale of TI products or services with statements different from or beyond the parameters stated by TI for that product or service voids all express and any implied warranties for the associated TI product or service and is an unfair and deceptive business practice. TI is not responsible or liable for any such statements.

Following are URLs where you can obtain information on other Texas Instruments products and application solutions:

<b>Products</b>		<b>Applications</b>	
Amplifiers	<a href="http://amplifier.ti.com">amplifier.ti.com</a>	Audio	<a href="http://www.ti.com/audio">www.ti.com/audio</a>
Data Converters	<a href="http://dataconverter.ti.com">dataconverter.ti.com</a>	Automotive	<a href="http://www.ti.com/automotive">www.ti.com/automotive</a>
DSP	<a href="http://dsp.ti.com">dsp.ti.com</a>	Broadband	<a href="http://www.ti.com/broadband">www.ti.com/broadband</a>
Interface	<a href="http://interface.ti.com">interface.ti.com</a>	Digital Control	<a href="http://www.ti.com/digitalcontrol">www.ti.com/digitalcontrol</a>
Logic	<a href="http://logic.ti.com">logic.ti.com</a>	Military	<a href="http://www.ti.com/military">www.ti.com/military</a>
Power Mgmt	<a href="http://power.ti.com">power.ti.com</a>	Optical Networking	<a href="http://www.ti.com/opticalnetwork">www.ti.com/opticalnetwork</a>
Microcontrollers	<a href="http://microcontroller.ti.com">microcontroller.ti.com</a>	Security	<a href="http://www.ti.com/security">www.ti.com/security</a>
		Telephony	<a href="http://www.ti.com/telephony">www.ti.com/telephony</a>
		Video & Imaging	<a href="http://www.ti.com/video">www.ti.com/video</a>
		Wireless	<a href="http://www.ti.com/wireless">www.ti.com/wireless</a>

Mailing Address: Texas Instruments  
Post Office Box 655303 Dallas, Texas 75265